

4K Video Conference Camera

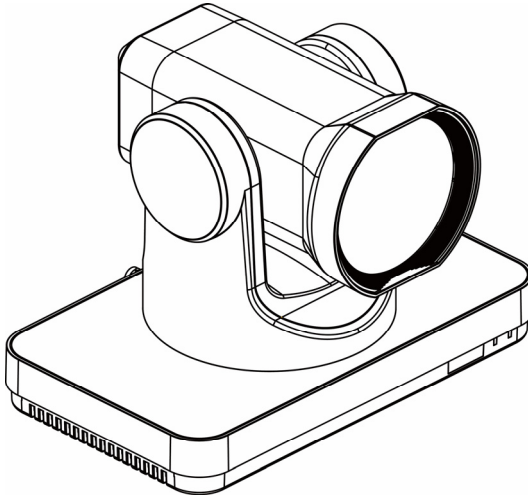

User Manual English (V1.2)

Copyright Notice

All contents of this manual, whose copyright belongs to our Corporation cannot be cloned, copied or translated without the permission of the company. Product specifications and information which were referred to in this document are for reference only. We may change, delete, or update any content at any time and without prior notice.



Warning

This is class A production. Electromagnetic radiation at specific frequencies may affect the image quality of TV in home environment.

Catalogue

- 1 Note..... 1
- 2 Packing List..... 1
- 3 Quick Start..... 1
- 4 DIP Switch..... 2
- 5 System Select Video Format..... 2
- 6 About Product..... 2
 - 6.1 Features..... 2
 - 6.2 Product Specification..... 3
 - 6.3 Interfaces and Buttons..... 4
 - 6.4 Dimension..... 4
 - 6.5 Remote Control..... 4
 - 6.6 RS-232 Interface..... 5
 - 6.7 VISCA Network..... 6
 - 6.8 Serial Communication Control..... 6
- 7 GUI Settings..... 7
 - 7.1 MENU..... 7
 - 7.2 EXPOSURE..... 7
 - 7.3 COLOR..... 7
 - 7.4 IMAGE..... 8
 - 7.5 P/T/Z..... 8
 - 7.6 NOISE REDUCTION..... 8
 - 7.7 SETUP..... 9
 - 7.8 RESTORE DEFAULT..... 9
- 8 Maintenance and Troubleshooting..... 10

1 Note

● Electric Safety

Installation and operation must accord with electric safety standard.

● Use caution to transport

Avoid stress, vibration or soaking in transport, storage and installation.

● Polarity of power supply

The power supply of this product is +12V, the max electrical current is 2.5A. Polarity of the power supply plug drawing shows as below.



● Installation Precautions

Do not grasp the camera lens when carrying it. Don't touch camera lens by hand. Mechanical damage may be caused by doing so.

Do not use in corrosive liquid, gas or solid environment to avoid any cover (plastic

material) damage. Make sure there is no obstacle within rotation range.

Please never power on before installation is completed.

● Do not dismantle the camera

We are not responsible for any unauthorized modification or dismantling.



Specific frequencies of electromagnetic field may affect the image of the camera!

2 Packing List

When you unpack, check that all the supplied accessories are included:

Name	Quantity
Camera	1
AC Power Adaptor	1
Power Cable	1
RS232 Cable (optional)	1
USB 3.0 Cable (optional)	1
Remote Control	1
User Manual	1

3 Quick Start

1) Please check connections are correct before starting.

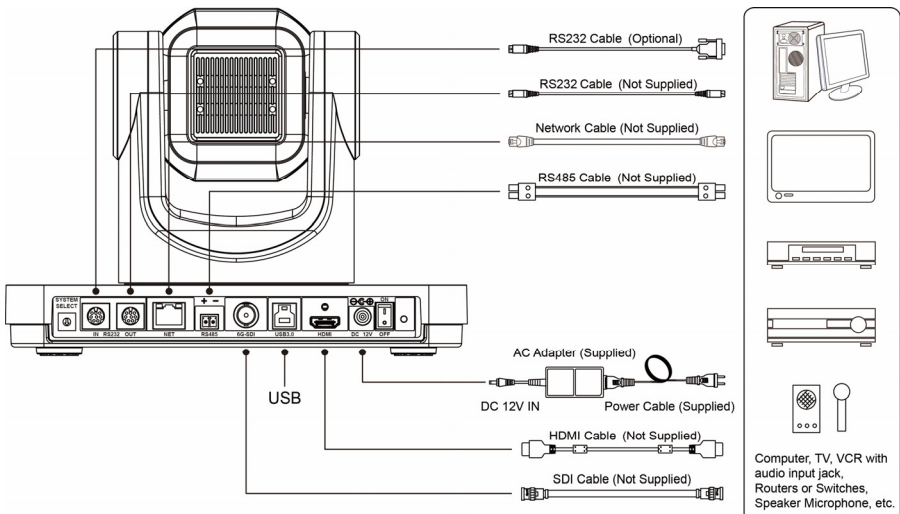

- 2) Connect the power adapter to the power connector on the rear panel of the camera. The power indicator on the front panel of the camera is on.
- 3) After the camera is powered on, it starts to initialize, right up to the limit position, and then both horizontal and vertical go to the middle position, the motor stops running, and the initialization is completed.
(Note: If preset 0 is saved, PTZ will be move to preset 0)

4 DIP Switch

The “SW1” of DIP switch be set to OFF state, then expression select normal working mode.

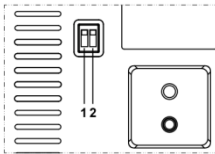

SW1	Explain
OFF	Normal Mode
ON	Upgrade Mode

5 System Select Video Format

No.	SW2=OFF	SW2=ON
0	4K@60fps (optional)	4K@59.94fps (optional)
1	4K@50fps (optional)	4K@50fps (optional)
2	4K@30fps	4K@29.97fps
3	4K@25fps	4K@25fps
4	1080P@60fps	1080P@59.94fps
5	1080P@50fps	1080P@50fps
6	1080I@60fps	1080I@59.94fps
7	1080I@50fps	1080I@50fps
8	1080P@30fps	1080P@29.97fps
9	1080P@25fps	1080P@25fps
A	720P@60fps	720P@59.94fps
B	720P@50fps	720P@50fps
C	720P@30fps	720P@29.97fps

No.	SW2=OFF	SW2=ON
D	720P@25fps	720P@25fps
E	--	--
F	DEBUG	DEBUG



After switching the video format, you need to restart the camera before taking effect!

6 About Product

6.1 Features

- **4K Ultra HD**

Using a new generation of SONY 1 / 1.7 inch, the largest 12.4 million pixel high-quality UHD CMOS sensor, it can provide 4K (3840x2160) ultra-high resolution high-quality images, and downwards compatibility with 1080p, 720p resolution, etc.

- **HDMI 1.4/2.0**

Support HDMI 1.4/2.0 version, and output uncompressed 4K original video.

- **Very Low Latency**

Unique patent 4K video ISP program produce lowest video delay. It is the first choice for the industry with high real-time requirement.

- **High Speed Interfaces**

Support HDMI, 6G-SDI and USB Interface, and it can output 4K video at the same time.

- **12x Wide-angle Lens**

Using high-quality ultra-wide focus lens, the maximum field of view up to 82°, and the optical zoom up to 12x.

- **Low Light**

The application of 2D and 3D noise reduction algorithm greatly reduces image noise. Even under the condition of ultra-low illumination, it still keep the picture clean and clear, and the SNR of image is as high as 55dB.

- **Remote Control**

Through the RS232 and RS485 serial ports, the camera can be controlled remotely.

6.2 Product Specification

Name	4K Video Conference Camera
Camera	
Video System	4K@60fps (optional), 4K@59.94fps (optional), 4K@50fps (optional), 4K@30fps, 4K@29.97fps, 4K@25fps, 1080P@60fps, 1080P@59.94fps, 1080P@50fps, 1080I@60fps, 1080I@59.94fps, 1080I@50fps, 1080P@30fps, 1080P@29.97fps, 1080P@25fps, 720P@60fps, 720P@59.94fps, 720P@50fps, 720P@30fps, 720P@29.97fps, 720P@25fps
Sensor	1/1.7", CMOS, Max Effective Pixel: 1240M
Scanning Mode	Progressive
Lens	12x, f = 4.2mm ~ 50.4mm, F1.8 ~ F2.8
Optical Zoom	12x
Minimum Illumination	0.05 Lux @ (F1.8, AGC ON)
Shutter	1/2s ~ 1/10000s
White Balance	Auto, Indoor, Outdoor, One Push, Manual
Backlight Compensation	Support
Digital Noise Reduction	2D & 3D Digital Noise Reduction
Signal Noise Ratio	≥55dB
Horizontal Angle of View	82.6° ~ 8°
Vertical Angle of View	51.9° ~ 4.58°
Horizontal Rotation Range	±170°

Vertical Rotation Range	±25°
Pan Speed Range	1.0° ~ 50.0°/s
Tilt Speed Range	0.8° ~ 10.0°/s
H & V Flip	Support
Number of Preset	255
Preset Accuracy	0.1°

Input/Output Interface

Communication Interface	1 x RS232 IN: 8pin Min DIN, Max Distance: 30m, Protocol: VISCA / Pelco-D / Pelco-P
	1 x RS-232 OUT: 8pin Min DIN, Max Distance: 30m, Protocol: VISCA network use only
	1 x RS-485: 2pin phoenix port, Max Distance: 1200m, Protocol: VISCA / Pelco-D / Pelco-P
Network Interface	1 x RJ45: 10/100/1000M Ethernet Interface
HDMI Interface	1 x HDMI: Version 1.4/2.0
6G-SDI Interface	1 x 6G-SDI: BNC type, 800mVp-p, 75Ω, SMPTE ST 2081-1, 292M, 424M standard
USB Interface	1 x USB 3.0: Type B
Power Jack	JEITA type (DC IN 12V)

Physical Parameter

Input Voltage	DC 12V
Current Consumption	2.5A (Max)
Operating Temperature	-10°C ~ 40°C
Storage Temperature	-40°C ~ 60°C
Power Consumption	30W (Max)
MTBF	>30000h
Size	240 x 173 x 180mm
Net Weight	2.83Kg

6.3 Interfaces and Buttons

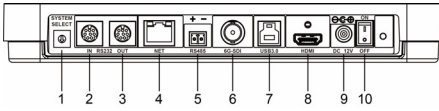

Item	Name
1	System Select Switch
2	RS232 IN Interface
3	RS232 OUT Interface
4	Network Interface
5	RS485 Interface
6	6G-SDI Interface
7	USB 3.0 Interface
8	HDMI Interface
9	DC 12V Interface
10	Power Switch

6.4 Dimension

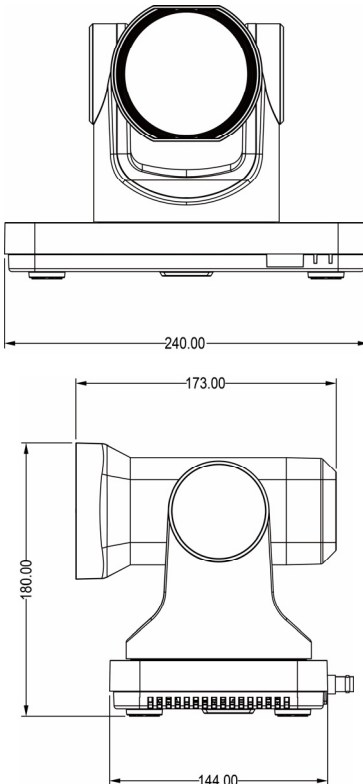

6.5 Remote Control

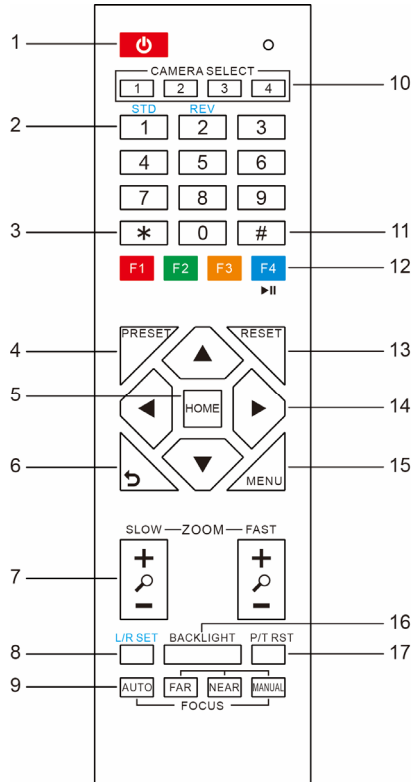

Key Description

- 1. Standby Key**
 Press this button to enter standby mode. Press it again to enter normal mode.
 Note: Power consumption in standby mode is approximately half of the normal mode
- 2. Number Key**
 To set preset or call preset.
- 3. *Key**
 Used with other buttons.
- 4. Preset Key**
 Set preset: Store a preset position.
 [SET PRESET] + Numeric button (0-9): Setting a corresponding numeric key preset position.
- 5. HOME Key**
 Confirm menu, enter the submenu or the PTZ will back to the middle position after pressed it

6. Return Key

Return back the last level menu

7. Zoom Key

Slow Zoom: Zoom In [+] or Zoom Out [-] slowly
Fast Zoom: Zoom In [+] or Zoom Out [-] fast

8. Left/Right Setting Key

Press with 1 buttons and 2 buttons setting the direction of the Pan-Tilt.

- Simultaneously press L/R Set +1[STD]: set the Pan-Tilt turn the same direction as the L/R Set.
- Simultaneously press L/R Set +2[REV]: set the Pan-Tilt turn the opposite direction as the L/R Set.

9. Focus Key

Used for focus adjustment.

Press [AUTO] adjust the focuses on the center of the object automatically. To adjust the focus manually.

Press [MANUAL] adjust the focus on the center of the object manual.

MANUAL button, and adjust it with [Far] (Focus on far object) and [NEAR] (Focus on near object).

10. Selection Key

Press the button corresponding to the camera you want to operate with the remote controller.

11. #Key

Used with other buttons.

12. IR Remote Control Key

[*]+[#]+[F1]: Address 1

[*]+[#]+[F2]: Address 2

[*]+[#]+[F3]: Address 3

[*]+[#]+[F4]: Address 4

13. Reset Key

Clear preset: Erase a preset position.

[CLEAR PRESET] + Numeric button (0-9)

Or: [*] + [#] + [CLEAR PRESET]: Erase all the preset individually.

14. PTZ Control Key

Press arrow buttons to perform panning and tilting. Press [HOME] button to face the camera back to front.

15. Menu Key

MENU: enter or exit OSD MENU.

16. Backlight Key

BLC ON/OFF: Press this button to enable the backlight compensation. Press it again to disable the backlight compensation.

NOTE:

- Effective only in auto exposure mode.
- If a light behind the subject, the subject will become dark. In this case, press the backlight ON/OFF button. To cancel this function, press backlight ON/OFF button.

17. PTZ Reset Key

Preset Pan/Tilt self-test.

18. Shortcut Set

[*]+[#]+[1]: OSD menu default English

[*]+[#]+[3]: OSD menu default Chinese

[*]+[#]+[6]: Quickly recover the default

[*]+[#]+[8]: Look the camera version

[*]+[#]+[9]: Quickly set up inversion

6.6 RS-232 Interface

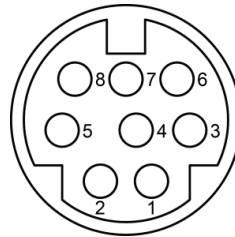

No.	Function
1	DTR
2	DSR
3	TXD
4	GND
5	RXD
6	GND
7	IR OUT
8	NC

The correspondence between the camera and Windows DB-9 pin:

Camera	Windows DB-9
1.DTR	1.CD
2.DSR	2.RXD
3.TXD	3.TXD
4.GND	4.DTR
5.RXD	5.GND
6.GND	6.DSR
7.IR OUT	7.RTS
8.NC	8.CTS
	9.RI

The correspondence between the camera and the Mini DIN pin:

Camera	Mini DIN
1.DTR	1.DTR
2.DSR	2.DSR
3.TXD	3.TXD
4.GND	4.GND
5.RXD	5.RXD
6.GND	6.GND
7.IR OUT	7.NC
8.NC	8.NC

6.7 VISCA Network

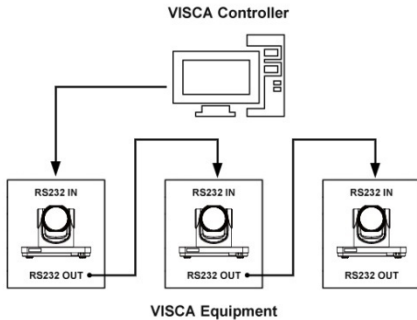

6.8 Serial Communication Control

● RS232 Communication Control

The camera is controlled via RS232. The RS232 serial port parameters are as follows:

Baud Rate: 2400/4800/9600/38400;

Starting Position: 1 bit

Data Bit: 8 bits

Stop Bit: 1 bit

Check Digit: None

● RS485 Communication Control

Control camera via RS485, half duplex mode:

Baud Rate: 2400/4800/9600/38400;

Starting Position: 1 bit

Data Bit: 8 bits

Stop Bit: 1 bit

Check Digit: None

After power on, the camera goes to the upper right limit and then back to the middle position.

The zoom lens is pulled to the farthest position, auto focus, and the aperture is adjusted to the default value. If the camera has preset 0 saved, the camera will be set to position 0 after the initialization is completed. At this point, the user can use the serial port command to control the camera.

● List of protocols (omitted)

The serial port of the camera follows the VISCA/Pelco-D/Pelco-P standard protocol. If secondary development is required, the camera can be controlled according to the standard protocol.

7 GUI Settings

7.1 MENU

Press [MENU] button to display the main menu on the normal screen, using arrow button to move the cursor to the item to be set. Press the [HOME] button to enter the corresponding sub-menu.

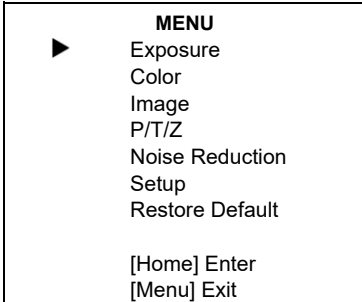

7.2 EXPOSURE

Move the main menu cursor to [EXPOSURE], and press [HOME] key enter the exposure page, as shown in the following figure.

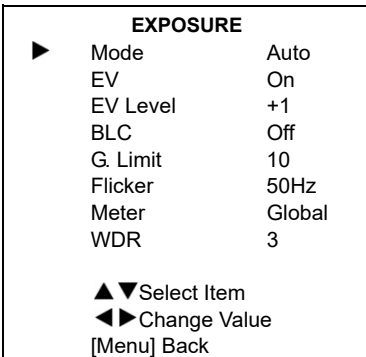

Mode: Exposure mode, optional items: Auto, Manual, SAE, AAE, Bright.

EV: Optional items: On, Off (Effective only in Auto mode).

EV Level: Exposure the compensation value, optional items: -7 ~ 7 (Effective only in Auto mode).

BLC: Set the backlight compensation, optional items: On, Off (Effective only in Auto mode).

G. Limit: Maximum gain limit, optional items: 0 ~ 15 (Effective only in Auto, Manual, SAE, AAE mode).

Flicker: Anti-flicker, optional items: Off, 50Hz, 60Hz (Effective only in Auto, AAE mode).

Iris: Aperture value, optional items: F1.8, F2.0, F2.4, F2.8, F3.4, F4.0, F4.8, F5.6, F6.8, F8.0, F9.6, F11.0, Close (Effective only in Manual, AAE mode).

Shutter: Optional items: 1/2, 1/4, 1/8, 1/15, 1/30, 1/60, 1/90, 1/100, 1/125, 1/180, 1/250, 1/350, 1/500, 1/725, 1/1000, 1/1500, 1/2000, 1/3000, 1/4000, 1/6000, 1/10000 (Effective only in Manual, SAE mode).

Meter: Optional items: Global, Center.

Bright: Intensity control, optional items: 0 ~ 23 (Effective only in Bright mode).

WDR: Optional items: 0 ~ 8.

7.3 COLOR

Move the main menu cursor to [COLOR], and press [HOME] key enter the color page, as shown in the following figure.

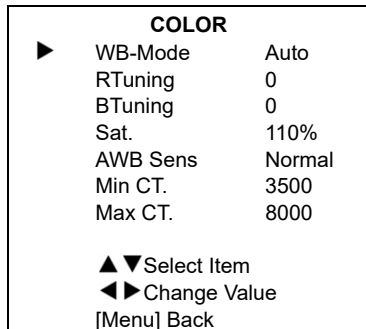

WB-Mode: White balance mode, optional items: Auto, Indoor, Outdoor, One Push, Manual.

RTuning: Red fine-tuning, optional items: -10 ~ +10 (Effective only in Auto mode).

BTuning: Blue fine-tuning, optional items: -10 ~ +10 (Effective only in Auto mode).

Sat.: Optional items: 60% ~ 200%.

Hue: Optional items: 0 ~ 14.

AWB Sens: The white balance sensitivity, optional items: Low, Normal, High.

RG: Red gain, optional items: 0 ~ 255 (Effective only in Manual mode).

BG: Blue gain, optional items: 0 ~ 255 (Effective only in Manual mode).

Min CT.: Optional items: 2500, 3000, 3500, 4000, 4500 (Effective only in Auto mode).

Max CT.: Optional items: 6000, 6500, 7000, 7500, 8000 (Effective only in Auto mode).

7.4 IMAGE

Move the main menu cursor to [IMAGE], and press [HOME] key enter the image page, as shown in the following figure.

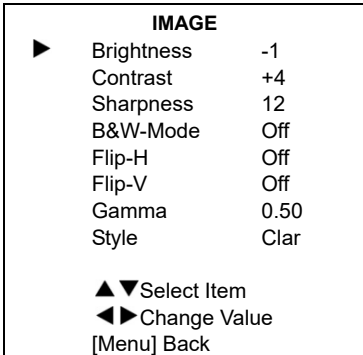

Brightness: Brightness adjustment, optional items: -5 ~ 5.

Contrast: Contrast adjustment, optional items: -5 ~ 5.

Sharpness: Sharpness adjustment, optional items: 0 ~ 15.

B&W-Mode: Optional items: On, Off.

Flip-H: Image flipped horizontally, optional items: On, Off.

Flip-V: Image Flip Vertical, optional items: On, Off.

Gamma: Optional items: 0.40, 0.45, 0.50, 0.55, 0.60, 0.65, 0.70, 0.75, 0.80, 0.85, 1.00.

Style: Optional items: Norm, Clarity, Bright, Soft.

7.5 P/T/Z

Move the main menu cursor to [P/T/Z], and press [HOME] key enter the P/T/Z page, as shown in the following figure.

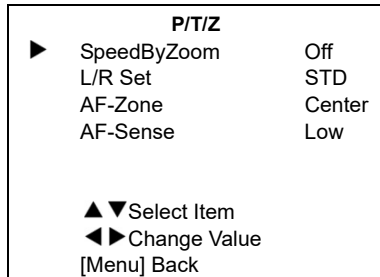

SpeedByZoom: The depth of field scale switch, optional items: On, Off.

L/R Set: Optional items: STD, REV.

AF-Zone: Interested in focusing area, optional items: Top, Center, Bottom.

AF-Sense: Automatic focusing sensitivity options, optional items: Low, Normal, High.

7.6 NOISE REDUCTION

Move the main menu cursor to [NOISE REDUCTION], and press [HOME] key enter the noise reduction page, as shown in the following figure.

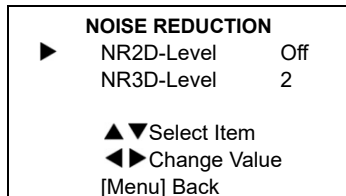

NR2D-Level: 2D noise reduction, optional items: Off, 1 ~ 5.

NR3D-Level: 3D noise reduction, optional items: Off, 1 ~ 5.

7.7 SETUP

Move the main menu cursor to [SETUP], and press [HOME] key enter the setup page, as shown in the following figure.

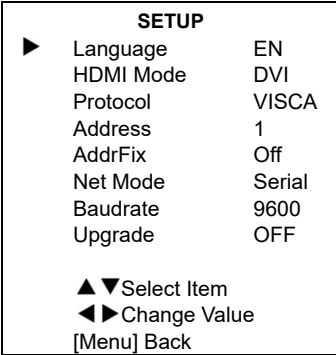

Language: Optional items: EN, Chinese.
 HDMI Mode: Optional items: DVI, HDMI.
 Protocol: Control protocol type, optional items: VISCA, PELCO-D, PELCO-P.
 Address: Optional items: 1 ~ 7 (Effective only in VISCA protocol).
 AddrFix: Optional items: On, Off (When set to On, useless in 88 30 01 FF Command).

P_D_Address: Optional items: 0 ~ 254. (Effective only in PELCO-D protocol).

P_P_Address: Optional items: 0 ~ 254. (Effective only in PELCO-P protocol).

Net Mode: Set the serial port network control, optional items: Serial, Paral.

Baudrate: Serial port baud rate, optional items: 2400, 4800, 9600.

Upgrade: Optional items: ON, OFF.

7.8 RESTORE DEFAULT

Move the main menu cursor to [RESTORE DEFAULT], and press [HOME] key enter the restore default page, as shown in the following figure.

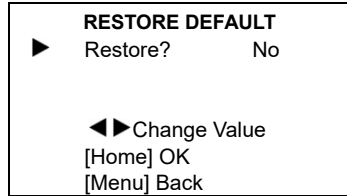

Restore: Confirm restore factory settings, optional items: Yes, No.

Note: Press [HOME] button to confirm, all parameter restore default, include IR Remote address and VISICA address.

8 Maintenance and Troubleshooting

Camera Maintains

- If camera will not be used for a long time, please turn off the power switch, disconnect AC power cord of AC adaptor to the outlet.
- Please use soft cloth or tissue to clean the camera cover.
- Please use the soft dry cloth to clean the lens. If the camera is very dirty, clean it with diluted neuter detergent. Do not use any type of solvents, which may damages the surface.

Unqualified Application

- No shooting extreme bright object for a long period of time, such as sunlight, light sources, etc.
- No operating in unstable lighting conditions, otherwise image will be flickering.
- No operating close to powerful electromagnetic radiation, such as TV or radio transmitters, etc.

Troubleshooting

Image

- The monitor shows no image
 - 1) Check that the camera power supply is connected, the voltage is normal, and the power indicator light is always on.
 - 2) Turn off the power switch to check whether the camera is self-testing.
 - 3) Check the cable of video platform and TV whether correct connection.

- Sometimes without the image

Check the cable of video platform and TV whether correct connection.

- Image have jitter when the camera lens at max multiple
 - 1) Check whether the camera installed position be stabled.
 - 2) Check whether have vibrating machinery or object near the camera.

Control

- Remote control can not control
 - 1) Check and replace the new battery for the remote controller.
 - 2) Check whether the camera working mode is correct.
 - 3) Check whether the address of remote control can match the camera.
- Series port can not control
 - 1) Check whether the camera protocol, address such is the same.
 - 2) Check whether the control line is connected well.