

UNI-T®

**Model UT512
OPERATING MANUAL**

Table of Contents

Title	Page
Introduction	5
Unpacking the Meter	5
Safety Information	6
International Electrical Symbols	8
Battery Saver (Sleep Mode)	8
Battery Indication	8
The Meter Structure	9
Display	12
Key Functions	14
Measurement Operation	17
A. Measuring Voltages	17
B. Measuring Insulation Resistance	19
a) Continuous Measurement	20
b) Timed Measurement	20
c) Polarization Index (PI) Measurement	21
d) Compare Function	22
The Use of Power Adaptor	23

Title	Page
USB Interface	24
Maintenance	25
A. General Service	25
B. Replacing the Battery	26
Specifications	27
Safety and Compliances	27
Physical Specifications	27
General Specifications	28
Feature Summary	28
Detailed Accuracy Specifications	29
A. Voltage Measurement	29
B. Insulation Resistance Measurement	30

List of Tables

Table	Title	Page
1.	Unpacking Inspection -----	5
2.	International Electrical Symbols -----	8
3.	Battery Indication -----	8
4.	Meter Front Description -----	10
5.	Meter Side Description -----	11
6.	Display Description -----	13
7.	Key Description -----	14

List of Figures

Figure	Title	Page
1.	The Meter Front Structure	9
2.	The Meter Side Structure	11
3.	Display	12
4.	Voltages Measurement	17
5.	Insulation Resistance Measurement	19
6.	The Use of Power Adaptor	23
7.	USB Interface Connection	24
8.	Battery Replacement	26

Introduction

Uni-Trend Model UT512 insulation resistance tester (hereafter, the Meter) is a handheld instrument designed primarily to make resistance/ insulation resistance measurement.

Unpacking the Meter

The Meter includes the following items:

Table 1. Unpacking Inspection

Item	Description	Qty
1	English Operating Manual	1 piece
2	One plug test lead to one alligator clip (Black colour)	1 piece
3	One plug test lead to one alligator clip (Green colour)	1 piece
4	Two plugs test lead to one alligator clip (Red colour)	1 piece
5	1.5V Battery (LR14 / R14)	8 pieces
6	Tool Box	1 piece
7	USB Interface Cable	1 piece
8	Software	1 piece
9	Power adaptor (input voltage 230V, 50/60Hz, 50mA, output DC14.5V, 600mA) (optionally, available at extra cost)	1 piece



In the event you find any missing or damage, please contact your dealer immediately.

Safety Information

This Meter complies with the standards IEC61010 safety measurement requirement: in pollution degree 2, overvoltage category (CAT. III 600V) and double insulation.

CAT II: Local level, appliance, PORTABLE EQUIPMENT etc., with smaller transient voltage overvoltages than CAT. III

Use the Meter only as specified in this operating manual, otherwise the protection provided by the Meter may be impaired.

-  **Danger** identifies conditions and actions that pose hazard(s) to the user.
-  **Warning** identifies avoiding electric shock.
-  **Caution** identifies conditions and actions that may damage the Meter and carrying out accurate measurement.

 **Operating Caution** identifies conditions that user needs to take extra care during operating the Meter

International electrical symbols used on the Meter and in this Operating Manual are explained on page 8.

Danger

Use of instrument in a manual not specified by the manufacturer may impair safety features/protection provided by the equipment. Read the following safety information carefully before using or servicing the instrument.

- Do not apply more than 600V.
- Do not use the Meter around explosive gas, vapor or dust.
- Do not use the Meter in a wet environment.
- When using the test leads, keep your figures away from the lead contacts. Keep your figures behind the finger guards on the leads.
- Do not use the Meter with any parts or cover removed.

- When carrying out insulation measurement, do not contact the circuit under test.



Warning

- Do not use the Meter if it is damaged or metal part is exposed. Look for cracks or missing plastic.
- Be careful when working above 33V rms, 46.7V ac rms or 70V DC. Such voltages pose a shock hazard.
- Discharge all loading of circuit under test after measuring high voltage.
- Do not change battery when the Meter is in wet environment.
- Place test leads in proper input terminals. Make sure all the test leads are firmly connected to the Meter's input terminals.
- Make sure the Meter is turned off when opening the battery compartment.











Caution

- When performing resistance tests, remove all power from the circuit to be measured and discharge all the power.
- When servicing the Meter, use only the same model number or identical electrical specifications of test leads and power adaptor.
- Do not use the Meter if the battery indicator () shows a battery empty condition. Take the battery out from the Meter if it is not used for a long time.
- Do not use or store the Meter in an environment of high temperature, humidity, explosive, inflammable and strong magnetic field. The performance of the Meter may deteriorate after dampened.
- Soft cloth and mild detergent should be used to clean the surface of the Meter when servicing. No abrasive and solvent should be used to prevent the surface of the Meter from corrosion, damage and accident.
- Dry the Meter before storing if it is wet.

International Electrical Symbols

International symbols on the Meter and in this manual are explained in Table 2.

Table 2. International Electrical Symbols

	Risk of electric shock
	Equipment protected by double or reinforced insulation.
	DC Measurement
	AC Measurement
	Grounding
	See Manual
	Empty of Built-In Battery
	Conforms to Standards of European Union





Battery Saver (Sleep Mode)

The Meter enters the Sleep Mode and blanks the display if there is no button press for 15 minutes. This is done to conserve battery power. The Meter comes out of Sleep Mode when **ON/OFF** button is pressed and hold for 1 second.

Battery Indication

There is a battery indicator shows on the display upper left hand corner. Below Table 3 is the explanation:

Table 3. Battery Indication

Battery Indicator	Battery Voltage
	5.9V ~ 10.6V. It means the battery is empty, don't use the Meter as it cannot guarantee accuracy.
	10.7V ~ 11.1V. It means the battery is nearly empty, replacing battery is necessary. At this status, the Meter can still do 500V and 1000V output measurement, accuracy will not be affected.
	11.2V ~ 12.2V
	12.2V or more

Model UT512: OPERATING MANUAL

The Meter Structure

Below Figure 1 and Table 4 shows the Meter front structure and description

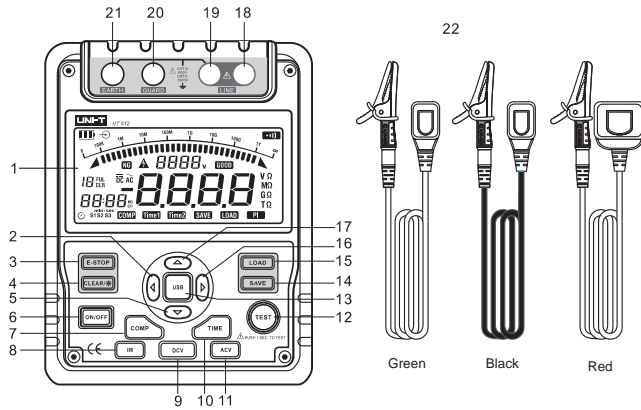

Figure 1. The Meter Front Structure

Table 4. Meter Front Description

1	LCD
2	◀ Scroll Button
3	Emergency Stop
4	Data Clear the Display Backlight Button
5	▼ Down Button
6	On/Off Button
7	Compare Button
8	Insulation Resistance Button
9	DC Voltages measurement Button
10	Timer Button.
11	AC Voltages measurement Button
12	Test Button
13	USB Button
14	Data Store Button.
15	Data Recall Button
16	▶ Scroll Button

17	▲ Up Button
18	LINE: High Voltage output input terminal (two plugs red test lead to one alligator clip)
19	High voltage line shielding input terminal (two plugs red test lead to one alligator clip)
20	GUARD: Grounding protection input terminal (one plug black test lead to one alligator clip)
21	EARTH: High resistance measurement input terminal (one plug green test lead to one alligator clip)
22	Testing leads: Two plugs red test lead to one alligator clip. One plug black test lead to one alligator clip. One plug green test lead to one alligator clip.

Model UT512: OPERATING MANUAL

Below Figure 2 and Table 5 shows the Meter side structure and description

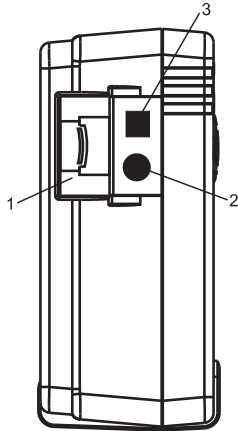

Figure 2. The Meter Side Structure

Table 5. Meter Side Description

1	Safety Shutter
2	Power adaptor Input Terminal
3	USB Port

Display

Table 6 and Figure 3 describe the display.

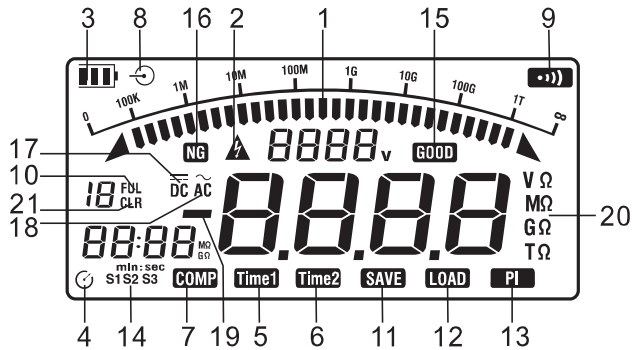

Figure 3. Display

Table 6. Display Description

Number	Meaning
1	Analogue bar graph
2	Risk of electric shock
3	Battery life indicator
4	Indicator for timer
5	Timer 1 symbol
6	Timer 2 symbo
7	Indicates selected pass/fail compare value
8	Indicator for power adaptor
9	The continuity buzzer is on
10	Indicator for data store full
11	Data store is on

Number	Meaning
12	Data recall is on
13	Indicator for polarization index
14	Step symbol
15	Compare feature pass
16	Compare feature fail
17	Indicator for DC voltage
18	Indicator for AC voltage
19	Indicates for negative reading
20	Unit symbols
21	Indicator for clearing

Key Functions

Table 7. Key Description

ON/OFF	Turn on or off the Meter. Press and hold the button for 1 second to turn the Meter on. Press again to turn off the Meter. The Meter default range is 500V insulation resistance continuous measurement when turning on.		value.
E-STOP	Emergency stop button. Press this button when the Meter is hang and cannot turn off the power.		
CLEAR / ☼	Press to turn on or off the display backlight Press and hold to clear the stored data		
SAVE	Press to store the current measurement value. The maximum number of stored reading is 18. When the stored readings memory is full, the Meter shows FULL and stop storing. Press and hold CLEAR / ☼ to clear the stored value in order to store the next measurement		
		LOAD	<ul style="list-style-type: none"> ● Press once to recall the first stored value. ● Press again to exit Load feature. ● Load feature can only be used when there is no high voltage output.
		▲	<ul style="list-style-type: none"> ● When the insulation resistance measurement has no testing voltage output, press to select one voltage range up. ● Under load mode: press to recall the previous stored value.
		▼	<ul style="list-style-type: none"> ● When the insulation resistance measurement has no testing voltage output, press to select one voltage range down. ● Under load mode: press to recall the next stored value.

Table 7. Key Description

◀	<ul style="list-style-type: none"> ● When set the timer duration for the measurement of insulation resistance or polarization index, press to decrement the time. The maximum length of time is 15 minutes and 30 seconds, the Meter will automatically carry out measurement. ● When compare feature measuring insulation resistance, press to decrement a resistance comparing value. ● After polarization index measurement, press to display polarization index, TIME 2 insulation resistance value and TIME 1 insulation resistance value in sequence. 	▶	<p>increment the time. The maximum length of time is 30 minutes and 30 seconds, the Meter will automatically carry out measurement.</p> <ul style="list-style-type: none"> ● When use the compare feature measuring insulation resistance, press to increment a resistance comparing value. ● After polarization index measurement, press to display polarization index, TIME 2 insulation resistance value and TIME 1 insulation resistance value in sequence.
▶	<ul style="list-style-type: none"> ● When set the timer duration for the measurement of insulation resistance or polarization index, press to 	USB	<ul style="list-style-type: none"> ● Press once to start the data transferring to the computer via USB, USB symbol shows on the display. ● Press again to stop the data transferring to the computer via USB, USB symbol disappears.

Table 7. Key Description

COMP	Set a pass / fail limit for insulation tests. The default value is 10MΩ
TIME	Pres to step through continuous measurement, timed measurement and polarization index measurement in sequence.
TEST	Press to stop or start an insulation resistance test
IR	Press to initiate insulation resistance measurement
DCV	Press to initiate DC voltage measurement
ACV	Pres to initiate AC voltage measurement

Measurement Operation

Below section explains how to make measurements.

Press and hold **ON/OFF** to turn on the Meter, press again to turn off the Meter. The Meter default range is 500V insulation resistance continuous measurement when turning on.

A. Measuring Voltages

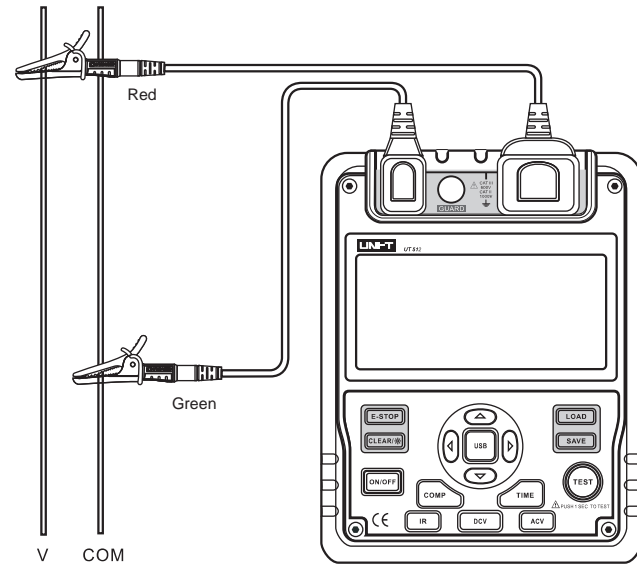

Figure 4. Voltages Measurement

Operating Caution

- **To avoid harms to you or damages to the Meter, please do not attempt to measure voltages higher than 600V or 600V rms, although readings may be obtained.**
- **Special care should be taken when measuring high voltage.**

To measure voltages, set up the Meter as Figure 4 and do the following:

1. Press **DCV** or **ACV** button to select DC voltage or AC voltage measurement
2. Insert the red and green test lead into the tested circuit.
3. When measuring DC voltage, if the red test lead is negative voltage, $\bar{\text{V}}$ symbol will show on the display.

Note

- When voltage measurement has been completed, disconnect the connection between the testing leads and the circuit under test and remove testing leads away from the input terminals of the Meter.

B. Measuring Insulation Resistance

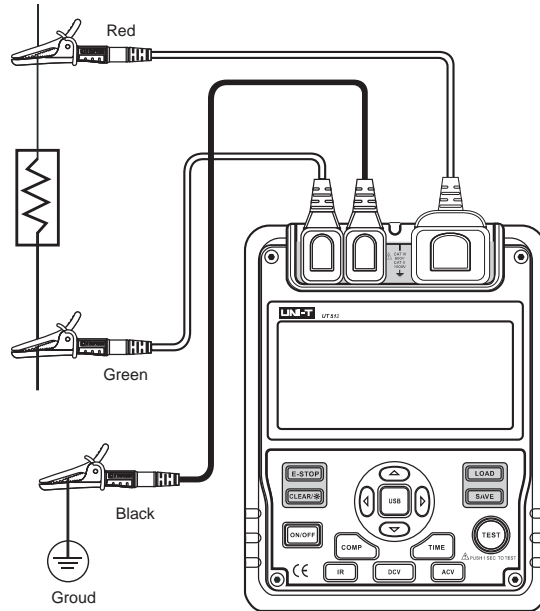

Figure 5. Insulation Resistance Measurement

⚠ Operating Caution

- When performing insulation resistance tests, remove all power from the circuit to be measured and discharge all the power.
- Operating the Meter must be very careful as it outputs dangerous voltage during measurement. Must make sure the tested object is firmly clipped, hands are away from the clips, then press TEST button to put high voltage.
- Do not short circuit the testing leads during high voltages output or test insulation resistance after high voltages output. This kind of incorrect operating may cause sparking and fire, which damages the Meter and harms to you.
- Do not measure over 10 seconds when:
 - 500V measure resistance lower than $2M\Omega$
 - 1000V measure resistance lower than $5M\Omega$
 - 1500V measure resistance lower than $8M\Omega$
 - 2500V measure resistance lower than $10M\Omega$

To measure insulation resistance, set up the Meter as Figure 5 and do the following:

1. Press **IR** button to select insulation resistance measurement.
2. When there is no testing voltage output, press ▲ and ▼ button to select voltages of 500V, 1000V, 2500V or 5000V.
3. When performing insulation resistance tests, remove all power from the circuit to be measured and discharged all the power.
4. Insert the red test lead into the **LINE** input terminal and the black test lead into **GUARD** input terminal.
5. Connect the red and green alligator clip to the circuit to be measured, negative voltage output from **LINE** terminal.
6. Choose below insulation resistance measurement mode.

a) Continuous Measurement

- Press **TIME** button to select continuous measurement mode, there is no timer icon on the LCD.
- Press ◀ and ▶ hold **TEST** button for 1 second to carry out continuous measurement. Output insulation resistance testing voltage, **TEST** button light up, ▲ blinks on every 0.5 seconds.
- Press **TEST** button to close the insulation resistance measurement voltage when measurement is completed. **TEST** button lights off, ▲ disappears. The LCD shows the current insulation resistance measurement value.

b) Timed Measurement

- Press **TIME** button to select timed measurement mode, the LCD displays **TIME 1** and ⌚ symbols.
- Press ◀ and ▶ buttons to set the time (00:10~15:00). Within 1 minute, the time increment or decrement by every 5 seconds. Afterward, the time increment or decrement by every 30 seconds.

- Then press and hold **TEST** button for 2 second to carry out timed measurement. **TIME 1** and \triangle are displayed and blinked on the LCD on every 0.5 seconds.
- When the set time is reached, the insulation resistance measurement voltage will be closed and the measurement will be automatically stopped. The LCD displays the insulation resistance reading.

c) Polarization Index (PI) Measurement

- Press **TIME** button to select timed measurement mode, the LCD displays **TIME 1** and \odot symbols.
- Press \blacktriangleleft and \blacktriangleright buttons to set the time (00:10~15:00). Within 1 minute, the time increment or decrement by every 5 seconds. Afterward, the time increment or decrement by every 30 seconds.
- Press **TIME** button again. **TIME 2, PI** and \odot symbols appear on the LCD.
- Press \blacktriangleleft and \blacktriangleright buttons to set the time (00:15~15:30). Within 1 minute, the time increment or decrement by every 10 seconds. Afterward, the time increment

or decrement by every 30 seconds.

- Then press and hold **TEST** button for 2 seconds to carry out timed measurement.
- **TIME 1** and \triangle are displayed and blinked on the LCD on every 0.5 seconds before **TIME 1** set time is reached.
- **TIME 2** and \triangle are displayed and blinked on the LCD on every 0.5 seconds before **TIME 2** set time is reached.
- When the two set time are reached, the insulation resistance measurement voltage will be closed and the measurement will be automatically stopped. The LCD displays the polarization index reading.
- Press $\blacktriangleleft, \blacktriangleright$ to set through the polarization index, **TIME 2** insulation resistance reading and **TIME 2** insulation resistance reading.

Information:

PI = 3 minutes ~10 minutes reading / 30 seconds ~1 minute reading

PI	4 or more	4~2	2.0~1.0	1.0 or less
Standard	The best	Good	Warning	Bad

d) Compare Function

- Press **COMP** button to select compare feature.
COMP symbol displays on the LCD..
- Press ◀ and ▶ buttons to set the compare value
- Below is the list in sequence of the compare value: 10MΩ, 20MΩ, 30MΩ, 40MΩ, 50MΩ, 60MΩ, 70MΩ, 80MΩ, 90MΩ, 100MΩ, 200MΩ, 300MΩ, 400MΩ, 500MΩ, 600MΩ, 700MΩ, 800MΩ, 900MΩ, 1GΩ, 2GΩ, 3GΩ, 4GΩ, 5GΩ, 6GΩ, 7GΩ, 8GΩ, 9GΩ, 10GΩ, 20GΩ, 330GΩ, 40GΩ, 50GΩ, 60GΩ, 70GΩ, 80GΩ, 90GΩ, 100GΩ
- Press and hold **TEST** button for 2 seconds to carry out the measurement.
- The **NG** symbol will display if the insulation resistance value is smaller than resistance value. Otherwise **GOOD** symbol will be displayed.

The Use of Power Adaptor

The use of power adaptor, see figure 6

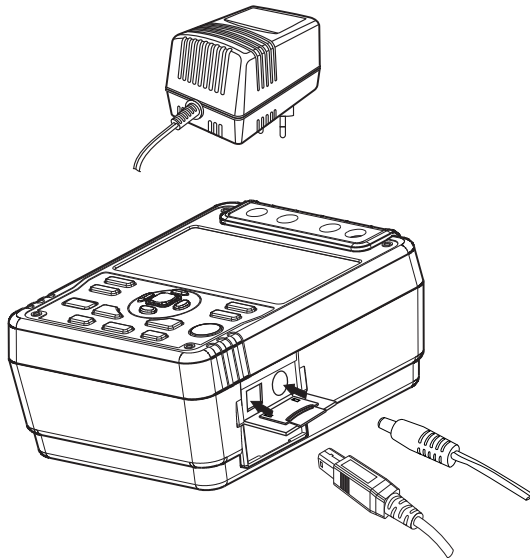

Figure 6. The Use of Power Adaptor

1. Open the side safety shutter, then you will see there is a power adaptor input terminal.
2. Make sure the Meter is power off and Insert the UT512 power adaptor to the input terminal.
3. It is highly recommended to take out all the batteries when you are using the power adaptor.
4. Make sure the Meter is power off when you disconnect the UT512 power adaptor from the Meter.
5. It is highly recommended to use Uni-Trend supplied UT512 power adaptor to avoid dangerous.

USB Interface

Connecting the USB interface, see figure 7

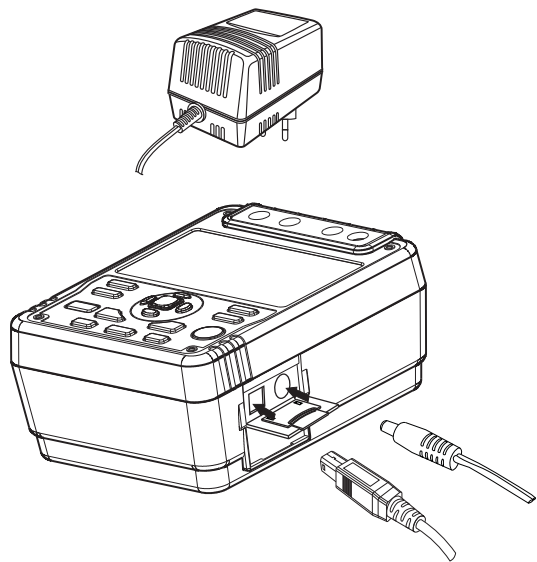

Figure 7. USB Interface Connection

1. Install the included software, the installation guide can be seen from the CD.
2. Open the side safety shutter, then you will see there is a USB port.
3. Insert the included USB cable to the Meter's USB port and the other end to the computer.

Maintenance

This section provides basic maintenance information including battery replacement instruction.

Warning

Do not attempt to repair or service your Meter unless you are qualified to do so and have the relevant calibration, performance test, and service information.

A. General Service

- Periodically wipe the case with a damp cloth and mild detergent. Do not use abrasives or solvents.
 - To clean the terminals with cotton bar with detergent, as dirt or moisture in the terminals can affect readings.
 - Turn the Meter to OFF when it is not in use.
 - Take out the battery when it is not using for a long time.
 - Do not use or store the Meter in a place of humidity, high temperature, explosive, inflammable and strong magnetic field.
- If the Meter is wet, dry it before use.

B. Replacing the Battery

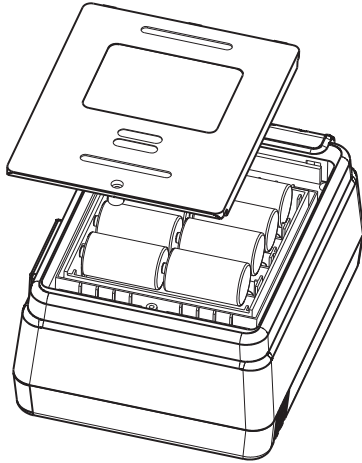



Figure 8. Battery Replacement

Warning

To avoid electric shock, remove all the test leads from the Meter when replacing the batteries.

Operating Caution

- Don't mix to use old and new batteries.
- Be careful the polarity is correct when installing batteries.
- Do not use the Meter if the battery indicator () shows a battery empty condition.
- Do you carry out measuring during the battery compartment is open.

Follow Figure 8 and proceed as follows to replace the battery:

- Turn the Meter to OFF and remove all connections from the terminals.
- Remove the screw from the battery compartment, and separate the battery compartment from the case bottom.
- Replace with 8pcs of new 1.5V (LR14) batteries.
- Rejoin the case bottom and battery compartment, and reinstall the screw.

Specifications

Safety and Compliances

Certification	CE
Compliances	IEC 61010 CAT.III 600V overvoltage and double insulation standard

Physical Specifications

Display (LCD)	Digital: 9999 counts Analog bar graph.
Operating Temperature	-10°C~40°C (14°F~104°F)
Storage Temperature	-20°C~60°C (-4°F~152°F)
Relative Humidity	≤ 85% @ -10°C~40°C below; ≤ 90% @ -20°C~60°C:
Battery Type	8pcs of 1.5V (LR14) batteries or power adaptor (input voltage 230V, 50/60Hz, 50mA, input DC14.5V, 600mA). Power adaptor is optionally at extra cost.
Dimensions (HxW xL)	202 x 155 x 94 mm
Weight	Approx 2kg (including battery)

General Specifications

Range	Auto
Overloading	Display OL on insulation resistance range
Battery Indicator	Display 
Icon Display	Equips with function and battery indicator icons.
Current Consumption	Maximum: around 600mA Average: around 20mA

Feature Summary

Display Backlight	Bright backlight for clear readings in poorly lighted areas.
Computer connection	Via USB interface.
Data Logging and Recall	18
Autorange	The Meter automatically selects best range
Warning	 and red light will on.
Voltage	Auto release voltage
COMP Measurement	Use the Compare function to set a pass/fail compare level for the insulation measurements.
PI Measurement	Polarization Index is the ratio of insulation resistance. You can pre-set two point of times and automatically carry out the measurement.
TIME	To carry out measurement by setting a specified time within 15 minutes.

Detailed Accuracy Specifications

Accuracy: \pm ([% of reading] + [number of least significant digits]), guarantee for 1 year.

Operating temperature: 18°C~28°C

Relative humidity: 45~75%RH

A. Voltage Measurement

	DC Voltage	AC Voltage
Measurement Range	$\pm 30 \sim \pm 600V$	30V~600V (50/60Hz)
Resolution	1V	
Accuracy	$\pm(2\%+5)$	<100V: $\pm(2\%+8)$ $\geq 100V$: $\pm(2\%+5)$

B. Insulation Resistance Measurement

Output Voltage	500V	1000V	1500V	2500V
Display Range	0.5MΩ~5.0GΩ	2MΩ~10.0GΩ	5MΩ~20.0GΩ	10MΩ~100GΩ
Open Circuit Voltage	DC 500V + 20%, -0%	DC1000V + 20%, -0%	DC 2500V + 20%, -0%	DC2500V + 20%, -0%
Test Current	1mA~1.2mA @500kΩ	1mA~1.2mA @ 1MΩ	1mA~1.2mA @ 1.5MΩ	1mA~1.2mA @ 2.5MΩ
Short Circuit	Less than 2.0mA			
Accuracy	100kΩ ~ 100MΩ: ±(3%+5) 100MΩ ~ 10GΩ: ±(5%+5) 10GΩ ~ 100GΩ: ±(10%+5)			

Operating Caution

At any output voltage, when the tested resistance is less than 10MΩ, the testing time cannot exceed 10 seconds continuously.

END

This operating manual is subject to change without notice.