

VICTOR[®]

DOBUL CLAMP DIGITAL PHASE METER

VICTOR 4000

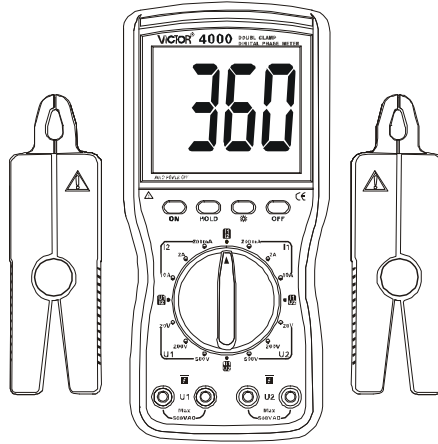

MANUAL

SHENZHEN VICTOR HI-TECH CO.,LTD.

Directory

Warning.....	1
A. Introduction.....	2
B. Electrical Symbols.....	3
C. Technical Specification.....	3
1. Base Conditions and Working Conditions.....	3
2. General Specification.....	3
3. Intrinsic error and performance indicators under base conditions.....	5
D. Instrument Structure.....	5
E. Method of Operation.....	6
1. Switch On/Off	6
2. Data Hold/Cancel.....	6
3. Backlight Control.....	6
4. Phase Measurement.....	7
5. AC Current, Leakage Current Measurement.....	8
6. AC Voltage Measurement.....	8
7. Inductive, Capacitive Circuit Judgment	9
8. Three-phase Voltage Phase Sequence Measurement.....	9
F. Battery Replacement	9
G. Other Descriptions and Notes.....	10
H. Configuration List	12
Attachment: Test Wiring Reference Drawing.....	12





Warning



Thank you for purchasing our **VICTOR4000 Double Clamp Digital Phase Meter**, in order to better use of this product, be sure to:

---- **To read this user manual carefully.**

---- **Comply strictly with safety rules and precautions set out in this manual.**

- ◆ Pay special attention to safety under any circumstances while using the instrument.
- ◆ Take note of the label text and symbols on the panel and back of the instrument.
- ◆ Make sure that the instrument and accessories are intact and there's no damage to the instrument or test wire insulation layer, or bare and broken wires before using it.
- ◆ Make sure that the function switch has been set up within the appropriate range before the test.
- ◆ Can not be used to test voltage higher than 500V.
- ◆ It's prohibited to use the instrument without the rear cover and battery cover in place.
- ◆ Make sure that the connection plug is closely inserted in the socket.
- ◆ Don't use or replace batteries if the instrument is wet.
- ◆ Test is prohibited in flammable and dangerous places.
- ◆ The test line could only be pulled out from the instrument after being removed from the measured wire; don't touch the plug jack by hand to avoid an electric shock.
- ◆ Do not use the instrument in strong electromagnetic environment in order to prevent the equipment from work improperly.
- ◆ Stop using the meter in case of metal exposure due to a broken chassis or fractured test line.
- ◆ Do not place or keep the device in hot and humid environment, or places of dew condensation or long time direct sunshine.
- ◆ The instrument and current clamp must be maintained regularly to keep clean, corrosive solution and coarse materials can't be used to clean the clamp.
- ◆ Keep the current clamp from any impact, especially the clamp joints.
- ◆ The instrument has an automatic shutdown function.
- ◆ Remove or replace the battery if the instrument is not used for a long time, and take note of the battery polarity.
- ◆ Take note of the measurement range and application environment required for the instrument.
- ◆ The operation, demolition, calibration and maintenance of the instrument must be carried out by qualified personnel authorized to do so.
- ◆ The meter should be stopped from being used immediately and sealed if danger is brought up in case of continued use; only a competent body can be authorized to deal with it.
- ◆ “” in the manual is the safety warning sign, the contents of this manual must be followed for safe operation.
- ◆ “” and other safety signs, the contents of this manual must be followed for safe operation.

A. Introduction







The **VICTOR4000 Double Clamp Digital Phase Meter** is a well-developed multi-functional

meter specifically designed for field testing, featuring high accuracy, high stability, low power consumption, easiness to use and so on. It can directly measure AC voltage and AC current opening the measured circuit, phases between two voltages, two currents and phase between the voltage and current; in addition, the power factor and power of the circuit can be indirectly measured, it can also be used to distinguish three-phase sequence, transformer wiring group, inductive and capacitive circuits, test second circuit and bus differential protection systems, read the phase relationship between CTs of the differential protection, check the meter wiring right, repair lines and equipment, etc.

The **VICTOR4000 Double Clamp Digital Phase Meter** has a large LCD screen displaying words as high as 40mm against a backlight, and looks exquisite and comfortable.

The **VICTOR4000 Double Clamp Digital Phase Meter** applies to electric power, petroleum chemical industry, metallurgy, railway, and meteorology, industrial and mining enterprises, scientific research institutions, measurement sector and so on.

B. Electrical Symbols

	Extremely dangerous! The operator must strictly abide by the safety rules; otherwise there is risk of electric shock, resulting in bodily injury or fatalities.
	Dangerous! The operator must strictly abide by safety rules; otherwise there is risk of electric shock, resulting in bodily injury or fatalities.
	Warning! Safety rules must be strictly abided by, otherwise personal injury or equipment damage may be caused.
	Alternate Current (AC)
	Direct Current (DC)
	Double Insulation

C. Technical Specification

1. Base Conditions and Working Conditions

Influence Quantity	Base Condition	Working Conditions	Remark
Ambient Temp	23℃±1℃	-10℃~40℃	
Ambient Humidity	40%~60%	< 80%	
Signal Waveform	sine wave	sine wave	β=0.05
Signal Frequency	50HZ±1HZ	45HZ~65HZ	
Meter Working Volt	9V±0.1V	9V±1V	
External Electric,	To be avoided		

Magnetic Field	
Measured Wire Position	Measured wire at approximately the geometric center of the clamp

2. General Specification

Function	Phase, AC current, AC voltage, AC leakage current, direct test of phase sequence; transformer groups, inductive, capacitive circuit discrimination; indirect test of power factor and power
Power	DC9V alkaline batteries (1.5V AAx6)
Consumption	About 35mA at most with enabled backlight, battery working continuously for about 40 hours About 5mA with disabled backlight, battery working continuously for about 300 hours
Display Mode	LCD display, backlight, suitable for dark places
LCD Size	70mmx62mm
LCD Display Field	64mmx54mmβ -
Meter Size	Length, Width, Height : 196mmx92mmx54mm
Clamp Size	φ7.5mmx13mm
Sampling Rate	About 3 times/second
Measurement Range	AC Voltage : 0~20V/200V/500V AC Current : 0~200mA/2A/10A Phase : 0~360°
Measured Signal Amplitude in Phase Test	U1-U2 phase test : 30V~500V I1-I2 phase test : 10mA~10.00A U1-I2 or I1-U2 phase test : 10V~500V、10mA~10.00A
Data Hold	Press HOLD key to keep data, "DH" symbol appears
Automatic Shutdown	Automatic shutdown about 15 minutes later after launching to reduce battery consumption
Voltage Detection	Low battery symbol "  " appears to remind the replacement of battery when the battery voltage drops below 7.8V~8V.
Weight	Main Unit about 550g (with battery), clamp about 170gx2, test line about 250g
Test Line Length	1.5m
Current Clamp Length	2m
Working Temperature and Humidity	-10℃~40℃ ; below 80%Rh
Storage Temperature and Humidity	-10℃~60℃ ; below 70%Rh
Input Impedance	Input impedance for all test voltage range : 2MΩ Input impedance when testing U1U2 phase : 40KΩ
Withstand Voltage	Withstand 1000V/50Hz sine wave AC voltage for 1 minute between the meter lines and shell; Withstand 500V/50Hz AC voltage sine wave for 1 minute between the two voltage

	inputs
Insulation	$\geq 10M\Omega$ between meter lines and shell or between the two voltage inputs
Structure	Double insulation

3. Intrinsic error and performance indicators under base conditions

Category	Measurement Range	Resolution	Intrinsic Error
Voltage	20V	0.01V	$\pm(1.2\%rdg+2dgt)$
	200V	0.1V	
	500V	1V	
Current	200mA	0.1mA	$\pm(1.0\%rdg+2dgt)$
	2A	1mA	
	10A	10mA	
Phase	0~360°	1°	$\pm 3^\circ$

D. Instrument Structure

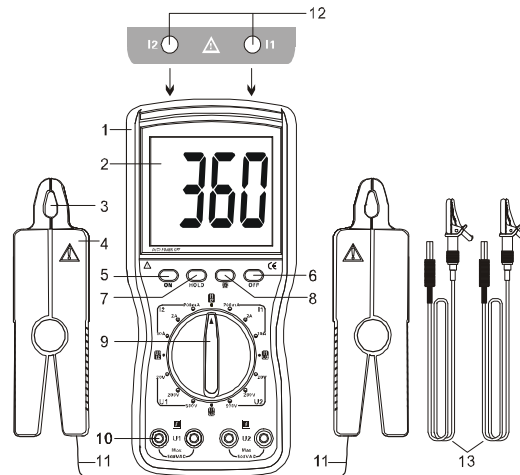

1. Anti-vibration insulation jacket
2. LCD display
3. Clamp ($\Phi 7.5mm \times 13mm$)
4. Current clamp
5. Power ON button
6. Power OFF button
7. Data Retention HOLD button
8. Backlight button
9. Function rotary switch
10. Voltage input jack (2 ways)
11. Current clamp leads
12. Current clamp input jack (2 ways)
13. Test line

E. Method of Operation

	Check carefully before using the instrument whether there're damaged parts, no damage is allowed
	The instrument is prohibited from use in dangerous places
	Install the battery according to the manual.

1. Switch On/Off

Press **ON** button to switch on as shown on the LCD or press **OFF** to switch off; the device powers off automatically about 15 minutes later

2. Data Hold/Cancel

Press **HOLD** key to display or cancel the data display.

3. Backlight Control

Press  to control the backlight in dim places.

	Electricity, dangerous! The operator must be trained and authorized to operate while strictly abiding by the safety rules, otherwise there is danger of electric shock, resulting in personal injury or equipment damage.
	Dangerous! Can not be used to measure voltage more than 500V, otherwise there is risk of electric shock, resulting in personal injury or equipment damage.
	Dangerous! Can not be used to measure current higher than 20A. Otherwise, there is risk of electric shock, resulting in personal injury or equipment damage.

	Before the test, you must first switch over the rotary function switch to the corresponding function indicator, connect the test line to the meter, and then connect the test line to the tested circuit.
	Connection must be in strict accordance with the manual.

	The test line must be removed from the measured line before being pulled out from the instrument.
--	---

4. Phase Measurement

	Phase Test relationship of the instrument: U1U2, I1I2, U1I2, I1U2, for every relationship the measured phase shows signal 1 ahead of signal 2.
	The red U1 and U2 voltage jacks and the red dot marks or arrow symbols on the clamp are dotted terminals
	In phase test the direction of the input current should be in line with the arrow symbol on the clamp
	The phase relationship of three-phase line could be tested in doubles.

(1) U1U2 Phase Test

Point the rotary switch to **U1U2**, connect the 4 black and red test lines with the voltage input jacks of **U1** and **U2**, and then connect the test lines with the **U1** and **U2** circuits; the result indicates the phase between the two circuits, namely the phase angle between **U1** and **U2**.

In **U1U2** phase test, the two input circuits are fully isolated by insulation to avoid short-circuit burning off caused by incorrect wiring.

(2) I1I2 Phase Test

Point the rotary switch to **I1I2**, connect the 2 current clamps to the current input jacks of **I1** and **I2**, and then connect the clamps with the **I1** and **I2** circuits; the result indicates the phase between the two currents.

- 7 -

(3) U1I2 Phase Test

Point the rotary switch to **U1I2**, connect the 2 black and red test lines with the voltage input jack of **U1** and the current clamp with the current input jack of **I2** in front; then connect the test lines with the **U1** and **I2** circuits; the result indicates the phase between the voltage and current.

(4) I1U2 Phase Test

Point the rotary switch to **I1U2**, connect the current clamp with the current input

jack of **I1** in front and the 2 black and red test lines with the voltage input jack of **U2**, and then connect the clamp and test line with the **I1** and **U2** circuits; the result indicates the phase between the current and voltage.

5. AC Current, Leakage Current Measurement

Point the rotary switch to the **10A** range of **I1**, connect 1 current clamp to the input **I1** current jack in front, and then connect the current clamp with the measured circuit; the result indicates the current or leakage current of the measured circuit. If the measured current is relatively lower, just choose lower range and try again, so as to improving the accuracy. Or point the rotary switch to the appropriate range of **I2** and test the current or leakage current with **I2**. Please note that the **I1** and **I2** pointed to by the switch must correspond to the **I1** and **I2** input jacks on the clamp.

6. AC Voltage Measurement

Point the rotary switch to the **500V** range of **U1**, connect 2 black and red test lines with the **U1** voltage input jack, and then connect the test line with the measured circuit; the result indicates the current or leakage current of the measured circuit. If the measured voltage is relatively lower, just choose lower range and try again, so as to improving the accuracy. Or point the rotary switch to the appropriate range of **U2** and test the voltage with **U2**. Please note that the **U1** and **U2** pointed to by the switch must correspond to the **U1** and **U2** input voltage jacks.

7. Inductive, Capacitive Circuit Judgment

Point the rotary switch to **U1I2**, input the circuit voltage into the **U1** jack and the circuit current into the **I2** jack, if the phase is displayed as between 0° and 90° , the measured load is inductive, if the phase is displayed as between 270° and 360° , the measured load is capacitive.

8. Three-phase Voltage Phase Sequence Measurement

(1) Phase Sequence Discrimination of Three-phase Three-wire System

Point the rotary switch to **U1U2**, use test lines to connect the **A** phase with the red **U1** jack, the **B** phase with the black **U1** and **U2** jacks, and the **C** phase with the red **U2** jack. If the measured phase value of is 300° , it's a positive phase sequence; if the measured phase is 60° , it's a negative phase sequence.

(2)Phase Sequence Discrimination of Three-phase Four-wire System

Point the rotary switch to **U1U2**, use test lines to connect the **A** phase with the red **U1** jack, the **B** phase with the red **U2** jack, and the null line with the black **U1** and **U2** jacks. If the measured phase value of is around 120° , it's a positive phase sequence; if the measured phase is 240° , it's a negative phase sequence.

F. Battery Replacement

	Take note of the battery polarity, the polarity must be properly installed, otherwise it causes damage to the instruments
	Batteries replacement is prohibited in hazardous area
	Must use qualified alkaline batteries (1.5V AA×6)
	Old and new batteries are not allowed to mix in use.

1. “**I +**” is displayed when the power voltage is lower than 7.8V~8V, indicating that the battery should be replaced as following.
2. Press **OFF** to switch off
3. Use the cross screwdriver to loose a screw on the battery cover, open the battery cover.
4. Remove the old batteries and replace a new battery, please take note of the battery polarity.
5. Cover the battery cover, tighten the screws.
6. Press **ON** to switch on to check whether the battery is successfully replaced, repeat step 2 if it doesn't work.
7. Take out the batteries if the instrument will not be used for a long time.

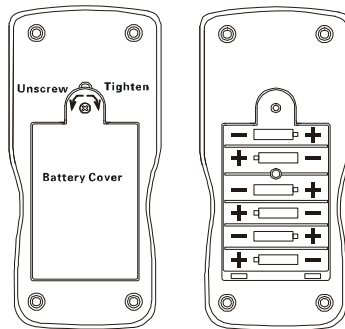

G. Other Descriptions and Notes

1. The special utility of current clamp

The two current clamps of each meter could only be used on this instrument.

The current clamp should be prevented from any impact, the clamp surface must be kept clean and could fully close for a reliable test.

2. The maintenance of current clamp

The dust on the surface of the current clamp should be removed promptly after use; don't use rough material or corrosive to clean the clamp, which is best to be gently wiped clean with soft cloth and lubricants (for example: **WD-40** lubricants).

3. Preheat 3 to 5 minutes before the measurement to ensure the measurement accuracy

4. The instrument should be used for secondary and low-voltage circuit detection, and cannot be used to measure the current of high-voltage lines to prevent electric shock.

5. Three-phase four-wire system (Phase of a balanced threephase load) :

Phase Relationship	Phase Value	Phase Relationship	Phase Value
Ua-Ub	120°	Ia-Ib	120°
Ub-Uc	120°	Ib-Ic	120°
Uc-Ua	120°	Ic-Ia	120°

6. Three-phase three-wire (Phase of a balanced threephase load) :

Phase Relationship	Phase Value	Phase Relationship	Phase Value
Uab-Ucb	300°	Ia-Ic	240°
Uab-Ia	30°	Ucb-Ic	330°

7. Three-phase four-wire vectogram and Three-phase three-wire vectogram :

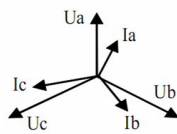

Three-phase four-wire vectogram

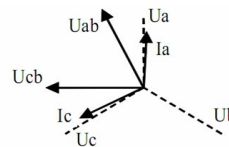

Three-phase three-wire vectogram

	If the direction of current clamp or current line is reversed there's a phase value difference of 180 °, viz. adding 180° to the standard value.
--	---

H. Configuration List

Main Unit	1
Meter Box	1
Current Clamp	2
Test Line	4 (2 Red and 2 Black)
Battery	6 (Alkaline Dry Battery : 1.5V AA)
Description	1
Guarantee Card	1
Certification	1

Attachment : Test Wiring Reference Drawing :

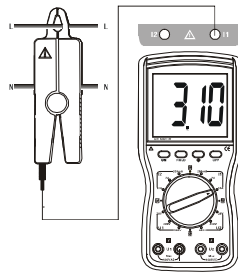

AC Current Measurement

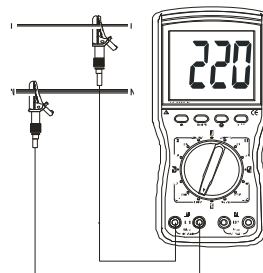

AC Voltage Measurement

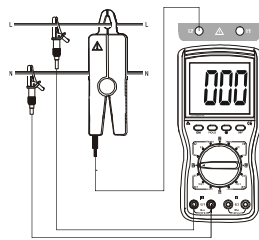

Test phase position of single-phase U-I
Determine inductive or capacitive circuit

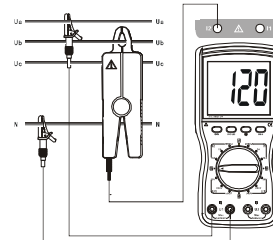

Test phase position of Three-phase four-wire Ua-Ib

Test Wiring Reference Drawing (Continuing):

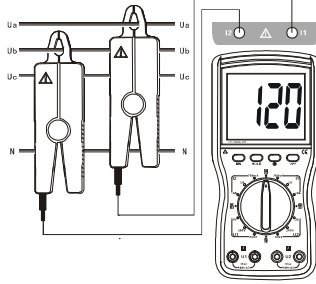

Test phase position of Three-phase four-wire **Ia-Ib**

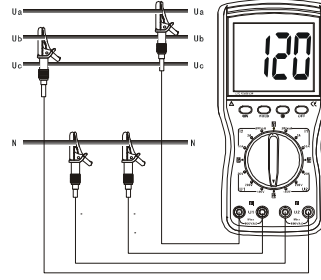

Test phase position of Three-phase four-wire **Ua-Ub**, and determine the phase sequence

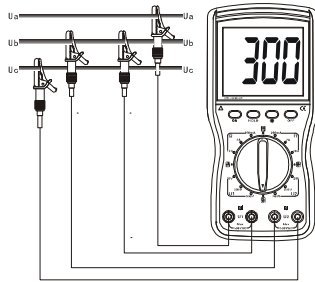

Test phase position of Three-phase three-wire **Uab-Ucb**, and determine the phase sequence

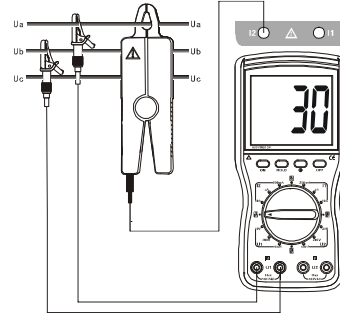

Test phase position of Three-phase three-wire **Uab-Ia**

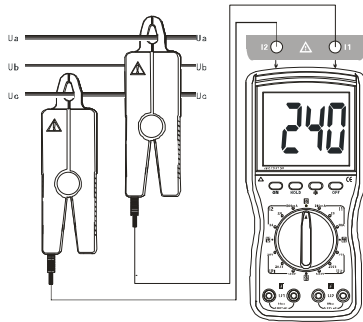

Test phase position of Three-phase three-wire **Ia-Ic**

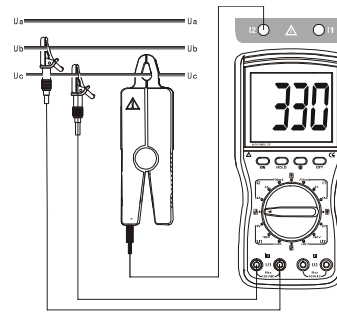

Test phase position of Three-phase three-wire **Ucb-Ic**