

Pioneer

Owner's Manual

DVD AV RECEIVER

AVH-P6350BT AVH-P5350DVD



Made for



iPod



iPhone



English

Thank you for purchasing this PIONEER product.

To ensure proper use, please read through this manual before using this product. It is especially important that you read and observe **WARNING**s and **CAUTION**s in this manual. *Please keep the manual in a safe and accessible place for future reference.*

Be sure to read this

- DVD video disc region numbers **6**
- Handling guidelines **97**

01 Precautions

IMPORTANT SAFEGUARDS **4**

To ensure safe driving **4**

To avoid battery exhaustion **5**

02 Before you start

About this unit **6**

Operating environment **6**

In case of trouble **6**

Protecting your unit from theft **6**

Resetting the microprocessor **7**

Demo mode **7**

Adjusting the response positions of the touch panels (Touch Panel Calibration) **8**

Use and care of the remote control **8**

03 What's what

Head unit **9**

Remote control **10**

04 Basic operations

Basic operations of this unit **11**

Operating the scroll icon and the scrubber bar **12**

Activating the touch panel keys **12**

Common operations for menu settings/lists **12**

Opening and closing the LCD panel **13**

Ejecting a disc **13**

Ejecting an SD **13**

Setting the clock **13**

05 Tuner

Introduction of tuner operations **14**

06 Playing moving images

Introduction of video playback operations **15**

07 TV tuner

Introduction of TV tuner operations **18**

08 Playing audio

Introduction of sound playback operations **19**

09 Playing still images

Introduction of still image playback operations **21**

Introduction of still image playback as a slideshow operations **22**

10 Bluetooth Telephone

Introduction of Bluetooth telephone operations **23**

11 Using Bluetooth wireless technology

Introduction of Bluetooth telephone operations **25**

Bluetooth audio operations **26**

12 Detailed instructions

Storing and recalling stations **28**

Storing the strongest stations **28**

Tuning in to strong signals **28**

Switching the media file type **28**

Operating the DVD menu **28**

Operating this unit's iPod function from your iPod **29**

Random play (shuffle) **29**

Playing all songs in random order (shuffle all) **30**

Repeating playback **30**

Playing videos from your iPod **30**

Browsing for a video/music on the iPod **31**

Resume playback (Bookmark) **31**

Frame-by-frame playback **31**

Slow motion playback **32**

Searching for the part you want to play **32**

Changing audio language during playback (Multi-audio) **32**

Changing the subtitle language during playback (Multi-subtitle) **32**

- Changing the viewing angle during playback (Multi-angle) **33**
- Return to the specified scene **33**
- Selecting audio output **33**
- PBC playback **33**
- Selecting tracks from the track title list **33**
- Selecting files from the file name list **34**
- Using S.Rtrv (sound retriever) **34**
- Changing audiobook speed **34**
- Displaying lists related to the currently playing song (Link Search) **34**
- Playing DivX® VOD content **35**
- Capture an image in JPEG files **35**
- Changing the wide screen mode **35**
- Calling a number in the phone book **36**
- Selecting a number by alphabet search mode **36**
- Using the missed, received and dialed call lists **37**
- Using the missed, received and dialed call lists on the optional Bluetooth adapter **37**
- Setting automatic answering **38**
- Adjusting the other party's listening volume **38**
- Switching the ring tone **38**
- Using the preset dial lists **38**
- Making a call by entering phone number **39**
- Setting the private mode **39**
- Pairing from this unit **39**
- Using a Bluetooth device to pair **40**
- Connecting to a Bluetooth device automatically **40**
- Switching visible unit **41**
- Displaying Bluetooth Device address **41**
- Entering PIN code for Bluetooth wireless connection **41**
- Using a cellular phone to initiate a connection **41**
- Registering a connected cellular phone **41**
- Voice recognition **42**
- Connecting a Bluetooth audio player **42**
- Connecting to a Bluetooth device automatically **42**
- Displaying Bluetooth Device address **42**
- 13 Menu operations**
 - Introduction of menu operations **43**
 - Audio Adjustments **44**
 - Digital Signal Processor **47**
 - Setting up the DVD player **57**
 - System settings **61**
 - Entertainment settings **68**
 - Customizing menus **69**
- 14 Other Functions**
 - Changing the picture adjustment **70**
 - Setting rear monitor output **70**
 - Adjusting the response positions of the touch panels (Touch Panel Calibration) **71**
 - Using an AUX source **71**
 - Using an external unit **72**
- 15 Installation**
 - Connecting the units **73**
 - Installation **85**
- Additional Information**
 - Troubleshooting **89**
 - Error messages **91**
 - Understanding auto EQ/auto TA and EQ error messages **94**
 - Understanding messages **95**
 - Indicator list **95**
 - Handling guidelines **97**
 - Compressed audio compatibility (disc, USB, SD) **99**
 - iPod compatibility **100**
 - Sequence of audio files **101**
 - Using the display correctly **101**
 - Copyright and trademark **102**
 - Language code chart for DVD **104**
 - Specifications **105**

IMPORTANT SAFEGUARDS

Please read all of these instructions regarding your display and retain them for future reference.

- 1 **Read this manual fully and carefully before operating your display.**
- 2 **Keep this manual handy as a reference for operating procedures and safety information.**
- 3 **Pay close attention to all warnings in this manual and follow the instructions carefully.**
- 4 **Do not allow other persons to use this system until they have read and understood the operating instructions.**
- 5 **Do not install the display where it may (i) obstruct the driver's vision, (ii) impair the performance of any of the vehicle's operating systems or safety features, including air bags, hazard lamp buttons or (iii) impair the driver's ability to safely operate the vehicle.**
- 6 **Do not operate this display if doing so in any way will divert your attention from the safe operation of your vehicle. Always observe safe driving rules and follow all existing traffic regulations. If you experience difficulty in operating the system or reading the display, park your vehicle in a safe location and make necessary adjustments.**
- 7 **Please remember to wear your seat belt at all times while operating your vehicle. If you are ever in an accident, your injuries can be considerably more severe if your seat belt is not properly buckled.**
- 8 **Never use headphones while driving.**
- 9 **To promote safety, certain functions are disabled unless the parking brake is on, and the vehicle is not in motion.**
- 10 **Never set the volume of your display so high that you cannot hear outside traffic and emergency vehicles.**



WARNING

- **Do not attempt to install or service your display by yourself. Installation or servicing of the display by persons without training and experience in electronic equipment and automotive accessories may be dangerous and could expose you to the risk of electric shock or other hazards.** 

To ensure safe driving



WARNING

- **LIGHT GREEN LEAD AT POWER CONNECTOR IS DESIGNED TO DETECT PARKED STATUS AND MUST BE CONNECTED TO THE POWER SUPPLY SIDE OF THE PARKING BRAKE SWITCH. IMPROPER CONNECTION OR USE OF THIS LEAD MAY VIOLATE APPLICABLE LAW AND MAY RESULT IN SERIOUS INJURY OR DAMAGE.**
- To avoid the risk of damage and injury and the potential violation of applicable laws, this unit is not for use with a video screen that is visible to the driver.
- To avoid the risk of accident and the potential violation of applicable laws, no viewing of front seat video should ever occur while the vehicle is being driven. Also, rear displays should not be in a location where they are visibly distracting to the driver.
- In some countries or states the viewing of images on a display inside a vehicle even by persons other than the driver may be illegal. Where such regulations apply, they must be obeyed and this unit's DVD features should not be used.

When you attempt to watch a video image while driving, the warning **Viewing of front seat video source while driving is strictly prohibited.** will appear on the front display.

Precautions

To watch a video image on the front display, park your vehicle in a safe place and apply the parking brake.

Parking brake interlock

Certain functions (Video viewing and certain touch panel keys) offered by this unit could be dangerous and/or unlawful if used while driving. To prevent such functions from being used while the vehicle is in motion, there is an interlock system that senses when the parking brake is set. If you attempt to use the functions described above while driving, they will become disabled until you stop the vehicle in a safe place, and (1) apply the parking brake, (2) release the parking brake, and then (3) apply the parking brake again. Please keep the brake pedal pushed down before releasing the parking brake.

When using a display connected to REAR MONITOR OUTPUT

Passengers in the rear seat can also watch moving images or still images if you connect this unit to a display using the **REAR MONITOR OUTPUT**.

WARNING

NEVER install the rear display in a location where the driver can watch a DVD or TV while driving.

When using the rear view camera

With an optional rear view camera, this unit can be used as an aid to keep an eye on trailers, or when backing into a tight parking spot.

WARNING

- **SCREEN IMAGE MAY APPEAR REVERSED.**
- **USE INPUT ONLY FOR REVERSE OR MIRROR IMAGE REAR VIEW CAMERA.**

OTHER USE MAY RESULT IN INJURY OR DAMAGE.

CAUTION

- The rear view camera function is to be used as an aid to keep an eye on trailers, or while backing up. Do not use for entertainment purposes.
- Please note that the edges of the rear view camera images may differ slightly according to whether full screen images are displayed when backing up, and whether the images are used for checking the rear when the vehicle is moving forward. 

To avoid battery exhaustion

Keep the vehicle engine running when using this unit to avoid draining the battery power.

- When no power is supplied to this unit, such as when the vehicle battery is being replaced, the microcomputer of this unit returns to its initial condition. We recommend that you transcribe the audio adjustment data.

WARNING

Do not use with vehicles that do not feature an ACC position. 

About this unit

CAUTION

This product is a class 1 laser product classified under the Safety of laser products, IEC 60825-1:2007, and contains a class 1M laser module. To ensure continued safety, do not remove any covers or attempt to gain access to the inside of the product. Refer all servicing to qualified personnel.

CLASS 1 LASER PRODUCT

CAUTION—CLASS 1M VISIBLE AND INVISIBLE LASER RADIATION WHEN OPEN. DO NOT VIEW DIRECTLY WITH OPTICAL INSTRUMENTS.

CAUTION:

USE OF CONTROL OR ADJUSTMENT OR PERFORMANCE OF PROCEDURES OTHER THAN THOSE SPECIFIED HEREIN MAY RESULT IN HAZARDOUS RADIATION EXPOSURE.

CAUTION:

THE USE OF OPTICAL INSTRUMENTS WITH THIS PRODUCT WILL INCREASE EYE HAZARD.

CAUTION

- Do not allow this unit to come into contact with liquids. Electrical shock could result. Also, damage to this unit, smoke, and overheating could result from contact with liquids.
- Keep this manual handy for future reference.
- Always keep the volume low enough to hear outside sounds.
- Avoid exposure to moisture.
- If the battery is disconnected or discharged, any preset memory will be erased.

DVD video disc region numbers

Only DVD video discs with compatible region numbers can be played on this player. You can find the region number of the player on the bottom of this unit and in this manual (refer to *Specifications* on page 105). 

Operating environment

This unit should be used within the temperature ranges shown below.

Operating temperature range: -10°C to $+60^{\circ}\text{C}$
EN300328 ETC test temperature: -20°C and $+55^{\circ}\text{C}$ 

In case of trouble

Should this product fail to operate properly, please contact your dealer or nearest authorized Pioneer Service Station. 

Protecting your unit from theft

The front panel can be detached to deter theft.

- If the front panel is not detached from the head unit within four seconds of turning off the ignition, a warning tone will sound.
- You can turn off the warning tone. Refer to *Switching the warning tone* on page 64.

Important

- Handle gently when removing or attaching the front panel.
- Avoid subjecting the front panel to excessive shock.
- Keep the front panel out of direct sunlight and high temperatures.
- If removed, replace the front panel on the unit before starting up your vehicle.
- To avoid damaging the device or vehicle interior, remove any cables and devices attached to the front panel before detaching it.

Before you start

Removing the front panel

- Pinch the top and bottom of its right side and pull the front panel out.

Take care not pinch it too tightly or to drop it, and also avoid contact with water or other fluids to prevent permanent damage.

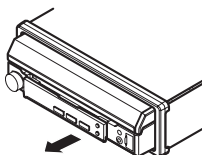

Re-attaching the front panel

- 1 Slide the front panel to the left.

The front panel and the head unit are connected on the left side. Make sure that the front panel has been properly connected to the head unit.

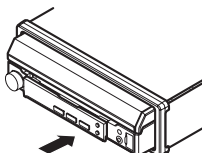

- 2 Press the right side of the front panel until it is firmly seated.

- If you can't attach the front panel to the head unit successfully, try again. Forcing the front panel into place may result in damage.

Resetting the microprocessor

By pressing **RESET**, you can reset the microprocessor to its initial settings without changing the bookmark information.

The microprocessor must be reset in the following situations:

- Before using this unit for the first time after installation
- If the unit fails to operate properly
- When strange or incorrect messages appear on the display

- 1 Turn the ignition switch OFF.

- 2 Press **RESET** with a pen tip or other pointed instrument.

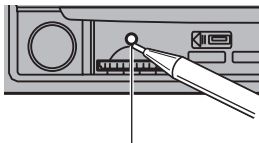

RESET button

Note

Switch your engine ON or set the ignition switch to ACC ON before pressing **RESET** in the following situations:

- After completing connections
- When erasing all stored settings
- When resetting the unit to its initial (factory) settings

Demo mode

The feature demo automatically starts when you select **Off** for the source and continues while the ignition switch is set to ACC or ON. To cancel the feature demo, press and hold **MUTE/** . Press and hold **MUTE/** again to restart. Operating the feature demo while the car engine is turned off it may drain the battery power.

Important

Failure to connect the red lead (ACC) of this unit to a terminal coupled with ignition switch on/off operations may lead to battery drain.

Adjusting the response positions of the touch panels (Touch Panel Calibration)

If you feel that the touch panel keys on the screen deviate from the actual positions that respond to your touch, adjust the response positions of the touch panel. Refer to *Adjusting the response positions of the touch panels (Touch Panel Calibration)* on page 71. 

Use and care of the remote control

Installing the battery

Slide the tray on the back of the remote control out and insert the battery with the plus (+) and minus (-) poles aligned properly.

- When using for the first time, pull out the film protruding from the tray.

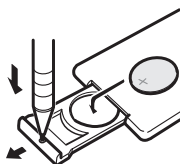

WARNING

- Keep the battery out of the reach of children. Should the battery be swallowed, consult a doctor immediately.
- Batteries (battery pack or batteries installed) must not be exposed to excessive heat such as sunshine, fire or the like.

CAUTION

- Use one **CR2025 (3V)** lithium battery.
- Remove the battery if the remote control is not used for a month or longer.
- There is a danger of explosion if the battery is incorrectly replaced. Replace only with the same or equivalent type.
- Do not handle the battery with metallic tools.

- Do not store the battery with metallic objects.
- If the battery leaks, wipe the remote control completely clean and install a new battery.
- When disposing of used batteries, comply with governmental regulations or environmental public institutions' rules that apply in your country/area.

Using the remote control

Point the remote control in the direction of the front panel to operate.

Important

- Do not store the remote control in high temperatures or direct sunlight.
- The remote control may not function properly in direct sunlight.
- Do not let the remote control fall onto the floor, where it may become jammed under the brake or accelerator pedal. 

What's what

Head unit

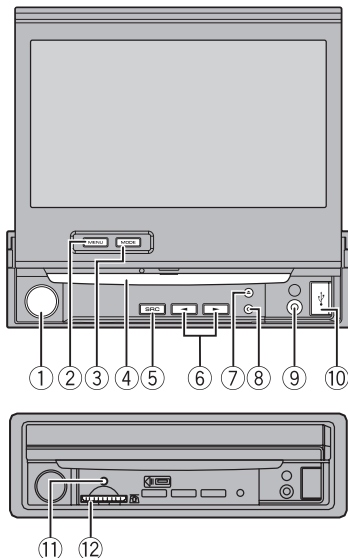

Part	Part
① Volume/MUTE/ (↻ : AVH-P6350BT only)	⑦ ▲ (eject)
② MENU Displaying the menu. Returning to the normal display.	⑧ OPEN/CLOSE
③ MODE Turning the information display off.	⑨ AUX input jack (3.5 mm stereo/video jack) Use to connect an auxiliary device. Auto EQ microphone input jack Use to connect an auto EQ microphone.
④ Disc loading slot	⑩ USB port When connecting, open the USB connector lid.

Part	Part
⑤ SRC/OFF	⑪ RESET
⑥ ◀▶ (TRACK/SEEK)	⑫ SD memory card slot

⚠ CAUTION

- Use an optional Pioneer USB cable (CD-U50E) to connect the USB audio player/USB memory as any device connected directly to the unit will protrude out from the unit and may be dangerous.
- Do not use unauthorized products.

Notes

- Insert an SD memory card with the contact surface facing down, and press on the card until it clicks and completely locks into place.
- Press and hold **MENU** to display

Picture Adjustment.

Refer to *Changing the picture adjustment* on page 70. ■

Remote control

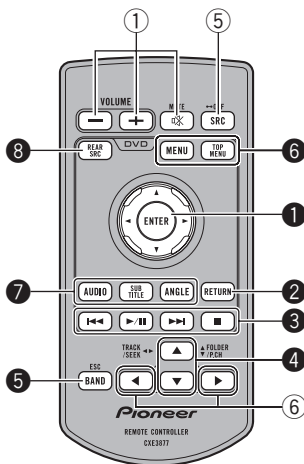

Part	Operation
1 Thumb pad	Click to recall Menu . Use to select a menu on the DVD menu.
2 RETURN	Press to display the PBC (playback control) menu during PBC playback.
▶/	Press to pause or resume playback.
◀◀	Press to return to the previous track (chapter).
3 ▶▶	Press to go to the next track (chapter).
■	Press to stop playback.
4 ▲/▼(FOLDER/PCH)	Press to select the next/previous folder. Press to recall radio station frequencies assigned to preset tuning keys.

Part	Operation
5 BAND/ESC	Press to select the tuner band when tuner is selected as a source. Also used to cancel the control mode of functions. Press to switch between modes when playing discs with compressed audio and audio data (CD-DA) such as CD-EXTRA and MIXED-MODE CDs.
6 MENU	Press to display the DVD menu during DVD playback.
6 TOP MENU	Press to return to the top menu during DVD playback.
7 AUDIO	Press to change the audio language during DVD playback. Press to switch audio output for Video CD/DivX.
7 SUBTITLE	Press to change the subtitle language during DVD/DivX playback.
8 ANGLE	Press to change the viewing angle during DVD playback.
8 REAR SRC	Press to cycle through all the available rear sources. Press and hold to turn the rear source off.



Basic operations

Basic operations of this unit

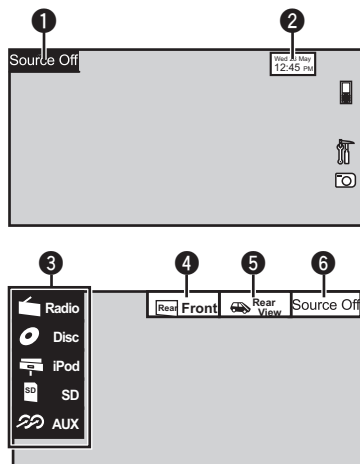

Touch panel keys

① **Source Off** Displaying the source menu.

② **Wed 28 May 12:45 PM** Switching to clock adjustment display. Refer to *Setting the clock* on page 13.

③ **Radio** Source icon
Selecting a favorite source. When the source icon is not displayed, it can be displayed by touching the screen.

④ **Rear Front** Switching the output source for the rear monitor. Refer to *Setting rear monitor output* on page 70.

⑤ **Rear View** Switching the rear view image on or off.

⑥ **Source Off** Turning the unit off.

Turning the unit on using the buttons

① Press **SRC/OFF** to turn the unit on.

Turning the unit off using the buttons

① Press **SRC/OFF** and hold until the unit turns off.

Selecting a source using the buttons

① Press **SRC/OFF** to cycle through the sources listed below:

Selecting a source using the touch panel keys

① Touch the source icon and then touch the desired source name.

- **Radio** – Radio
- **TV** – Television
- **AV** – AV input
- **Disc** – Built-in DVD player
- **USB/iPod** – USB/iPod
- **SD** – SD memory card
- **EXT1** – External unit 1
- **EXT2** – External unit 2
- **AUX** – AUX
- **TEL/Audio** – Bluetooth telephone/audio (Function of AVH-P5350DVD)
- When the source icon is not displayed, it can be displayed by touching the screen.
- While operating the menu, you cannot select a source by touching the source icon.

Adjusting the volume

① Turn **MUTE**/ to adjust the volume.

Notes

- In this manual, iPod and iPhone will be referred to as "iPod".
- The **USB/iPod** icon will change as follows:
 - **USB** is displayed when a USB storage device is connected.
 - **iPod** is displayed when an iPod is connected.
 - **USB/iPod** is displayed when no device is connected.
- When appropriately set up, the image from the rear view camera can be displayed automatically. For details, refer to *Setting the rear view camera (back up camera)* on page 64.
- An external unit refers to a Pioneer product, such as those which will be available in the future. Although incompatible as a source, the basic functions of up to two external units can be controlled with this unit. When two external units are connected, the external units are automatically allocated to external unit 1 or external unit 2.

Operating the scroll icon and the scrubber bar

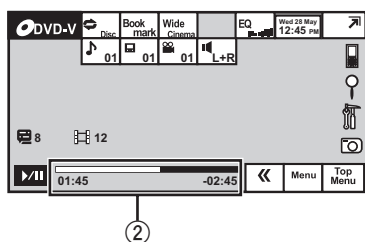
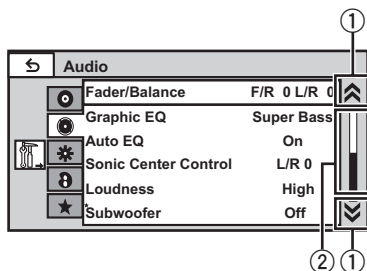

- ① Scroll icon
Appears when selectable items are hidden.
- ② Scrubber bar
Appears when the playback point can be specified or set by dragging.

Viewing the hidden items

- ① Touch the scroll icon or drag the scrubber bar to view any hidden items.

- Also, you can drag the list to view any hidden items.

Specifying the playback point

- ① Drag the scrubber bar on the screen.
(Not available when the scrubber bar is grayed out.)

Activating the touch panel keys

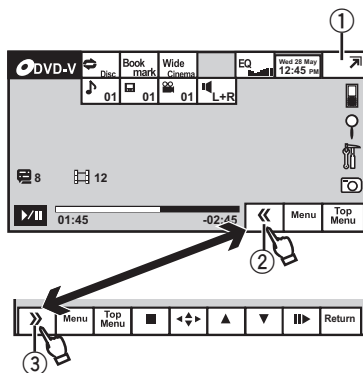

Touch panel keys

- ①  Turning the display to simplified display.
Returning to the normal display by touching the screen when playing moving images.
Returning to the normal display by touching the same icon when playing audio.

- ②  Viewing the hidden touch panel keys.

- ③  Shorten the touch panel area.

Common operations for menu settings/lists



(Function of AVH-P6350BT)

Starting the Bluetooth telephone menu.

Refer to *Introduction of Bluetooth telephone operations* on page 23.



Displaying the list menu.

Starting the search function.

Basic operations



Displaying the menu.
Refer to *Introduction of menu operations* on page 43.



Displaying still images as a slide show when listening to another source.
Viewing slide shows.
Refer to *Introduction of still image playback operations* on page 21.



Returning to the previous display.
Returning to the previous list/category (the folder/category one level higher).



Opening and closing the LCD panel

The LCD panel will open or close automatically when the ignition switch is turned on or off. You can turn off the automatic close/open function.

- Do not close the LCD panel by force with your hands. That will cause a malfunction.
- The automatic close/open function will operate the display as follows.
 - When the ignition switch is turned OFF while the LCD panel is opened, the LCD panel will close after six seconds.
 - When the ignition switch is turned ON again (or turned to ACC), the LCD panel will open automatically.
 - Removing or attaching the front panel will automatically close or open the LCD panel. (Refer to *Protecting your unit from theft* on page 6.)
- When the ignition switch is turned OFF after the LCD panel has been closed, turning the ignition switch ON again (or turning it to ACC) will not open the LCD panel. In this case, press **OPEN/CLOSE** to open the LCD panel.
- When closing the LCD panel, check to make sure that it has closed completely. If the LCD panel has stopped halfway, leaving it like this could result in damage.



CAUTION

Keep hands and fingers clear of the unit when opening, closing, or adjusting the LCD panel. Be especially cautious of children's hands and fingers.

- **Press OPEN/CLOSE to open the LCD panel.**
 - To close the LCD panel, press **OPEN/CLOSE** again.

Turning the LCD panel horizontally

When the LCD panel is upright and hinders the operation of the air conditioner, the panel can be turned horizontally temporarily.

- **Press and hold OPEN/CLOSE to turn the LCD panel horizontally.**
 - To return to the original position, press and hold **OPEN/CLOSE** again.
 - The LCD panel returns to the original position automatically, indicated with a beeping sound 10 seconds after operation. 

Ejecting a disc

- 1 **Press ▲ (eject).**
- 2 **Eject a disc.** 

Ejecting an SD

- 1 **Remove the front panel.**
Refer to *Removing the front panel* on page 7.
- 2 **Push an SD.**
- 3 **Eject an SD.** 

Setting the clock

- 1 **Switch to Clock Adjustment display.**
Refer to *Basic operations of this unit* on page 11.
- 2 **Select the item to set.**
- 3 **Touch ▲ or ▼ to set the correct date and time.** 

Introduction of tuner operations

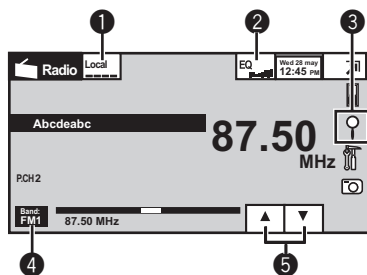



Note

Listening AM radio while an iPod is charged from this unit may generate noise. In this case, disconnect the iPod from this unit.

Touch panel keys

1  Turning local seek tuning on and off.
Refer to *Tuning in to strong signals* on page 28.

2  Switching the equalizer curves.
Refer to *Using the equalizer* on page 44.
Touch and hold for more than two seconds to turn the auto-equalizer on or off.
Refer to *Using the auto-equalizer* on page 45.

3  Displaying the preset channel list.
Refer to *Storing and recalling stations* on page 28.
Refer to *Storing the strongest stations* on page 28.

4  Selecting a band (FM1, FM2, FM3 for FM or AM).

5  Recalling radio station frequencies assigned to preset tuning keys.

Manual tuning (step by step) using the buttons

1 Press ◀ or ▶ (**TRACK/SEEK**).

Seek tuning using the buttons

1 Press and hold ◀ or ▶ (**TRACK/SEEK**).

Playing moving images

Introduction of video playback operations

You can view DVD/DVD-R/DVD-RW/CD/CD-R/CD-RW/USB/SD/iPod.

If an iPod with video capabilities is connected to this unit using an interface cable such as the CD-IU50V (sold separately), you can enjoy the video contents of the iPod as an **iPod** source.

DVD video

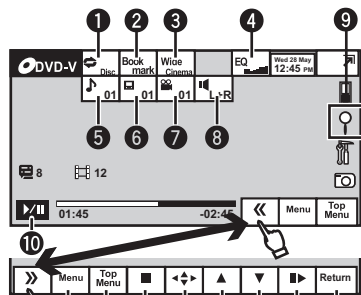

Video CD

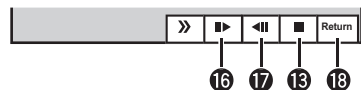



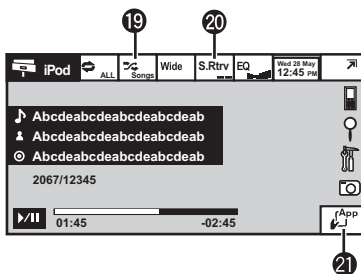



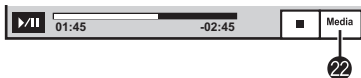

iPod video



When playing a disc containing a mixture of various media file types



Touch panel keys

- 1  Selecting the repeat range. Refer to *Repeating playback* on page 30.
- 2  During playback, touch the point at which you want to resume playback the next time the disc is loaded. Refer to *Resume playback (Bookmark)* on page 31.
- 3  Changing the screen mode. Refer to *Changing the wide screen mode* on page 35.
- 4  Switching the equalizer curves. Refer to *Using the equalizer* on page 44. Touch and hold for more than two seconds to turn the auto-equalizer on or off. Refer to *Using the auto-equalizer* on page 45.
- 5  Switching between audio languages during playback. Refer to *Changing audio language during playback (Multi-audio)* on page 32.
- 6  Switching between subtitle languages during playback. Refer to *Changing the subtitle language during playback (Multi-subtitle)* on page 32.
- 7  Switching among viewing angles during playback. Refer to *Changing the viewing angle during playback (Multi-angle)* on page 33.
- 8  Switching the audio output, when playing video discs recorded with LPCM audio. Refer to *Selecting audio output* on page 33. Switching between stereo and monaural audio output, when playing Video CD discs.

Playing moving images

9



Starting the search function. Refer to *Searching for the part you want to play* on page 32. Refer to *Selecting files from the file name list* on page 34. Displaying iPod menus. Refer to *Playing videos from your iPod* on page 30 and *Browsing for a video/music on the iPod* on page 31.

10



Pausing playback. Returning to normal playback during paused, slow motion, or frame-by-frame playback.

11



Displaying the DVD menu during DVD playback. Refer to *Operating the DVD menu* on page 28.

12



Returning to the top menu during DVD playback.

13



Stopping playback. Stopping playback at the point set in Resume playback. Touch one more time to stop playback completely when playing DivX. Refer to *Resume playback (Bookmark)* on page 31.

14



Displaying arrow keys to operate the DVD menu. Refer to *Using the arrow keys* on page 28.

15



Skipping to another title. Selecting a folder during DivX file playback.

16



Moving ahead one frame at a time during playback. Refer to *Frame-by-frame playback* on page 31. Touch and hold for more than two seconds to slow down playback speed. Speeding up the playback speed in four steps during slow motion playback on DVD video/Video CD.

17



Speeding down the playback speed in four steps, during slow motion playback on Video CD.

18



Returning to the specified scene to which the DVD currently being played has been preprogrammed to return. Refer to *Return to the specified scene* on page 33.

19



Playing the video on your iPod in a random order. Refer to *Random play (shuffle)* on page 29.

20



Switching the Advanced sound retriever function setting when playing a video on your iPod. Refer to *Using S.Rtrv (sound retriever)* on page 34.

21



Conducting operation from your iPod and listening to it using your car's speakers. Refer to *Operating this unit's iPod function from your iPod* on page 29.

22



Switching between media file types to play on DVD/CD/USB/SD. Refer to *Switching the media file type* on page 28.

Playing moving images

Playing back videos

- 1 Insert the disc into the disc loading slot with the label side up.
Playback will automatically start.
- If you are playing a DVD or Video CD, a menu may appear. Refer to *Operating the DVD menu* on page 28 and *PBC playback* on page 33.
 - When the automatic playback function is on, the unit will skip the DVD menu and automatically start playback from the first chapter of the first title. Refer to *Automatic playback of DVDs* on page 60.
 - While an iPod is connected to this unit, **PIONEER, Accessory Attached** or ✓ (check mark) is displayed on the iPod.
 - When the source icon is not displayed, it can be displayed by touching the screen.
 - Disconnect headphones from the iPod before connecting it to this unit.
 - Depending on the iPod model and the amount of data stored in the iPod, it may take some time for playback to begin.
 - Use the touch panel keys to select the iPod after connecting it to this unit.
 - **No Device** is displayed when disconnecting the iPod.
 - If a message is displayed after loading a disc containing DivX VOD content, touch **Play**. Refer to *Playing DivX® VOD content* on page 35.

Ejecting a disc

- 1 Refer to *Ejecting a disc* on page 13 or *Ejecting an SD* on page 13.

Selecting a chapter using the buttons

- 1 Press ◀ or ▶ (**TRACK/SEEK**).

Fast forwarding or reversing using the buttons

- 1 Press and hold ◀ or ▶ (**TRACK/SEEK**).
- Fast forward/fast rewind may not always be possible on some discs. In such cases, normal playback will automatically resume.

tails, refer to *Resume playback (Bookmark)* on page 31.

- Some operations may not be available while watching a media due to the programming of the disc. In such cases, the ⏸ icon appears on the screen.
- To ensure proper operation, connect the dock connector cable from the iPod directly to this unit.
- While the iPod is connected to this unit, the iPod cannot be turned on or off. However, the iPod can be turned on or off when you select an SD as the source. ■

Notes

- This DVD player can play back a DivX file recorded on CD-R/RW or DVD-R/RW. (Please see the following section for files that can be played back. Refer to *DivX video files* on page 99.)
- Do not insert anything other than a DVD (-R/-RW) or CD (-R/-RW) into the disc loading slot.
- If the bookmark function is on, DVD playback resumes from the selected point. For more de-

Introduction of TV tuner operations

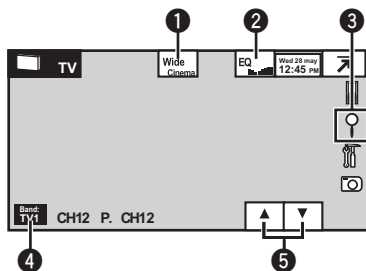

You can use this unit to control a TV tuner, such as the GEX-P5750TVP (sold separately).

For details concerning operation, refer to the TV tuner's operation manual. This section provides information on TV operations with this unit, which differs from that described in the TV tuner's operation manual.

Touch panel keys

1

Wide

Changing the screen mode. Refer to *Changing the wide screen mode* on page 35.

2

EQ

Switching the equalizer curves. Refer to *Using the equalizer* on page 44. Touch and hold for more than two seconds to turn the auto-equalizer on or off. Refer to *Using the auto-equalizer* on page 45.

3



Displaying the preset screen. Refer to *Storing and recalling stations* on page 28. Refer to *Storing the strongest stations* on page 28.

4

Band:

Selecting a band.

5



Recalling radio station frequencies assigned to preset tuning keys. Refer to *Storing and recalling stations* on page 28.

Manual tuning (step by step) using the buttons

1 Press ◀ or ▶ (TRACK/SEEK).

Seek tuning using the buttons

1 Press and hold ◀ or ▶ (TRACK/SEEK).

Notes

- Refer to *Setting the video signal* on page 65 to set the TV signal.
- Refer to *Selecting the area group* on page 65 to select the area group. ■

Playing audio

Introduction of sound playback operations

You can listen to DVD-R/DVD-RW/CD/CD-R/CD-RW/USB/SD/iPod sound files.

CD

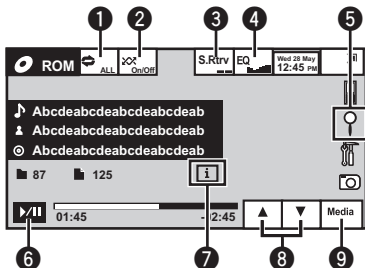

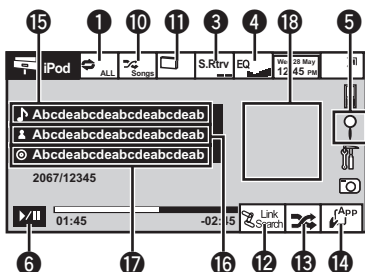

iPod audio



You can control an iPod with this unit by using a cable such as the CD-IU50V (sold separately).

Touch panel keys

- | | | |
|---|---|---|
| 1 |  | Selecting the repeat range.
Refer to <i>Repeating playback</i> on page 30. |
| 2 |  | Playing songs in random order.
Refer to <i>Random play (shuffle)</i> on page 29. |
| 3 |  | Switching the S.Rtrv (sound retriever) function setting when playing audio.
Refer to <i>Using S.Rtrv (sound retriever)</i> on page 34. |



Switching the equalizer curves.
Refer to *Using the equalizer* on page 44.
Touch and hold for more than two seconds to turn the auto-equalizer on or off.
Refer to *Using the auto-equalizer* on page 45.



Displaying a list of track titles to select songs on a CD.
Refer to *Selecting tracks from the track title list* on page 33.
Displaying the file name list to select the files.
Refer to *Selecting files from the file name list* on page 34.
Displaying iPod menus.
Refer to *Browsing for a video/music on the iPod* on page 31.



Pausing and starting playback.



Switching the text information to display on this unit when playing MP3/WMA/AAC files.



Selecting a folder.



Switching between media file types on a DVD/CD/USB/SD.
Refer to *Switching the media file type* on page 28.



Playing songs on the iPod in random order.
Refer to *Random play (shuffle)* on page 29.



Changing the speed of audiobook playback on the iPod.
Refer to *Changing audiobook speed* on page 34.

Playing audio

12



Switching to Link Search mode to play songs related to the currently playing song on the iPod. Refer to *Displaying lists related to the currently playing song (Link Search)* on page 34.

13



Playing all songs on the iPod in random order. Refer to *Playing all songs in random order (shuffle all)* on page 30.

14



Conducting operation from your iPod and listening to it using your car's speakers. Refer to *Operating this unit's iPod function from your iPod* on page 29.

Text information

15



Displaying the **Songs** list on the iPod. Refer to *Searching for a video/music by category* on page 31.

16



Displaying the **Artists** list on the iPod. Refer to *Searching for a video/music by category* on page 31.

17



Displaying the **Albums** list on the iPod. Refer to *Searching for a video/music by category* on page 31.

Artwork display

18

Starting **Album Link Search** on your iPod when you touch the artwork display. Refer to *Displaying lists related to the currently playing song (Link Search)* on page 34.

Playing back sound

- 1 Insert the disc into the disc loading slot with the label side up. Playback will automatically start.
 - While an iPod is connected to this unit, **PIONEER, Accessory Attached** or ✓ (check mark) is displayed on the iPod.
 - When the source icon is not displayed, it can be displayed by touching the screen.
 - Disconnect headphones from the iPod before connecting it to this unit.
 - Depending on the iPod model and the amount of data stored in the iPod, it may take some time for playback to begin.
 - Use the touch panel keys to select the iPod after connecting it to this unit.
 - **No Device** is displayed when disconnecting the iPod.

Ejecting a disc

- 1 Refer to *Ejecting a disc* on page 13 or *Ejecting an SD* on page 13.

Selecting a track using the buttons

- 1 Press ◀ or ▶ (**TRACK/SEEK**).

Fast forwarding or reversing using the buttons

- 1 Press and hold ◀ or ▶ (**TRACK/SEEK**).

Notes

- When playing back files recorded as VBR (variable bit rate) files, the play time will not be correctly displayed if fast forward or reverse operations are used.
- To ensure proper operation, connect the dock connector cable from the iPod directly to this unit.
- While the iPod is connected to this unit, the iPod cannot be turned on or off. However, the iPod can be turned on or off when you select an SD as the source.
- If the characters recorded on the disc are not compatible with this unit, those characters will not be displayed.
- Text information may not be correctly displayed depending on the recorded environment.
- Disconnect the USB portable audio player/USB memory when you are done using it.
- When you select **Clock** or **Speana** on *Selecting the background display* on page 68, the artwork is not displayed. ■

Playing still images

Introduction of still image playback operations

You can view still images saved in CD-R/CD-RW/USB/SD.

CD

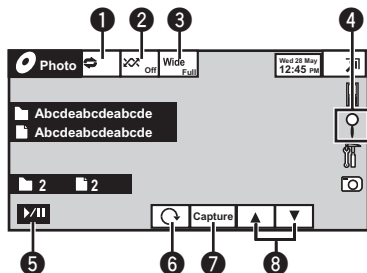

When playing a disc containing a mixture of various media file types

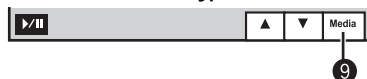

When loading a CD-R/CD-RW/USB/SD containing JPEG picture files, this unit starts a slideshow from the first folder/picture on the disc/device. The player displays the pictures in each folder on the CD-R/CD-RW in alphabetical order by file name.

The table below shows the controls for viewing a slideshow.

Touch panel keys

1		Selecting the repeat range. Refer to <i>Repeating playback</i> on page 30.
2		Playing files in a random order. Refer to <i>Random play (shuffle)</i> on page 29.
3	Wide	Changing the screen mode. Refer to <i>Changing the wide screen mode</i> on page 35.
4		Displaying the file name list to select the files. Refer to <i>Selecting files from the file name list</i> on page 34.

5		Starting or pausing the slideshow.
6		Rotating the displayed picture 90° clockwise.
7	Capture	Capturing an image in JPEG files. Refer to <i>Capture an image in JPEG files</i> on page 35.
8		Selecting a folder.
9	Media	Switching between media file types. Refer to <i>Switching the media file type</i> on page 28.

Playing still images

- 1 Insert the disc into the disc loading slot with the label side up. Playback will automatically start.
 - When the source icon is not displayed, it can be displayed by touching the screen.

Ejecting a disc.

- 1 Refer to *Ejecting a disc* on page 13 or *Ejecting an SD* on page 13.

Selecting a file using the buttons

- 1 Press ◀ or ▶ (**TRACK/SEEK**).

Fast file searching

- 1 Press and hold ◀ or ▶ (**TRACK/SEEK**).
 - You can search 10 JPEG files at a time.

Notes

- This unit can play back a JPEG file recorded on CD-R/CD-RW/SD/USB storage device. (Please see the following section for files that can be played back. Refer to *JPEG picture files* on page 99.)
- Files are played back in file number order and folders are skipped if they contain no files. (If folder **01** (ROOT) contains no files, playback commences with folder **02**.)

Introduction of still image playback as a slideshow operations

You can view still images saved in CD-R/CD-RW/USB/SD as a slideshow when listening to another source.

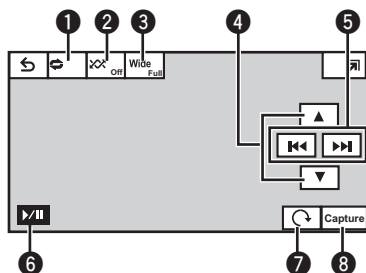

The table below shows the controls for viewing a slideshow.

Touch panel keys

1		Selecting the repeat range. Refer to <i>Repeating playback</i> on page 30.
2		Playing files in a random order. Refer to <i>Random play (shuffle)</i> on page 29.
3		Changing the screen mode. Refer to <i>Changing the wide screen mode</i> on page 35.
4		Selecting a folder.
5		Selecting a file.
6		Starting or pausing the slideshow.

7		Rotating the displayed picture 90° clockwise.
8		Capturing an image in JPEG files. Refer to <i>Capture an image in JPEG files</i> on page 35.

1 Start slideshow when listening to another source.

Refer to *Common operations for menu settings/lists* on page 12.



Displaying still images as a slide show.

2 Select the device containing the files that you want to display.

- **Disc** – Built-in DVD player
 - **USB** – USB
 - **SD** – SD memory card
- To cancel searching, touch **Cancel**.

Note

When the USB or SD source is selected, this unit cannot view still images on USB/SD as a slideshow.

Bluetooth Telephone

Introduction of Bluetooth telephone operations

Telephone standby display

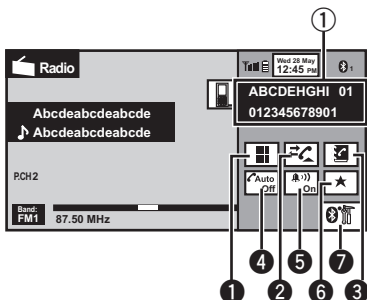

When switching to the entering phone number mode

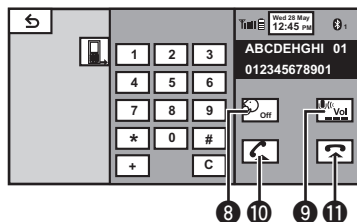

You can use Bluetooth telephone (AVH-P6350BT only).

Important

- Since this unit is on standby to connect with your cellular phone via Bluetooth wireless technology, using it without the engine running can drain the battery power.
- Advanced operations that require attention such as dialing numbers on the monitor, etc., are prohibited while driving. Park your vehicle in a safe place when using these advanced operations.
- Operations available may be limited depending on the cellular phone connected to this unit.
- Be sure to park your vehicle in a safe place and apply the parking brake when performing this operation.

① Incoming call notice

Indicates that an incoming call has been received and has not been checked yet.

- Not displayed for calls made when your cellular phone is disconnected from this unit.

Touch panel keys

- | | | |
|---|--|---|
| ① | | Switching the mode to enter the phone number directly. Refer to <i>Making a call by entering phone number</i> on page 39. |
| ② | | Switching to the call history list. Refer to <i>Using the missed, received and dialed call lists</i> on page 37. |
| ③ | | Switching to the phone book mode. Refer to <i>Calling a number in the phone book</i> on page 36. Refer to <i>Selecting a number by alphabet search mode</i> on page 36. |
| ④ | | Turning automatic answering on or off. Refer to <i>Setting automatic answering</i> on page 38. |
| ⑤ | | Turning the ring tone for incoming calls on or off. Refer to <i>Switching the ring tone</i> on page 38. |
| ⑥ | | Displaying the preset dial screen. Refer to <i>Using the preset dial lists</i> on page 38. |
| ⑦ | | Displaying the Bluetooth connection menu. Refer to the instructions from page 39 to page 41. |
| ⑧ | | Turning private mode on or off. Refer to <i>Setting the private mode</i> on page 39. |
| ⑨ | | Adjusting the other party's listening volume. Refer to <i>Adjusting the other party's listening volume</i> on page 38. |

Bluetooth Telephone

10



Accepting an incoming call.
Making a phone call, when selecting a phone number.
Switching between callers on hold.

11



Ending a call.
Rejecting an incoming call.
Canceling call waiting.

Notes

- You can also use **MUTE**/ to accept an incoming call, end a call and reject an incoming call.
- Private mode can only be operated while you are talking on the phone.
- To end the call, both you and the other caller must hang up your phones.

Setting up for hands-free phoning

Before you can use the hands-free phoning function you must set up the unit for use with your cellular phone. This entails establishing a Bluetooth wireless connection between this unit and your phone, registering your phone with this unit, and adjusting the volume level.

1 Connection

First, you need to connect a Bluetooth telephone to this unit.

For detailed instructions on connecting your phone to this unit via Bluetooth wireless technology, see following section. *Using a Bluetooth device to pair* on page 40 and *Pairing from this unit* on page 39.

2 Volume adjustment

Adjust the earpiece volume of your cellular phone to your preference. The unit will record the adjusted volume level as the default setting.

- The volume of the caller's voice and ring tone may vary depending on the type of cellular phone.
- If there is a large volume difference between the ring tone and caller's voice, the overall volume level may become unstable.
- Make sure to adjust the volume to a proper level before disconnecting the cellular phone from the unit. If the volume is muted (zero level) on your cellular phone, the volume level of your cellular phone remains muted even after the cellular phone is disconnected.



Using Bluetooth wireless technology

Introduction of Bluetooth telephone operations

During a call

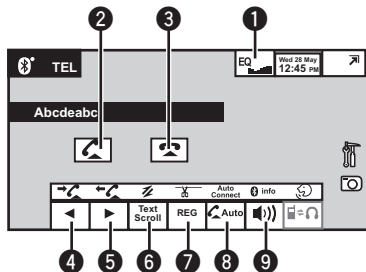

Except during a call

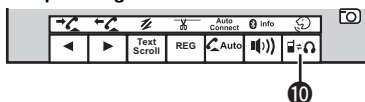

When you connect a Bluetooth adapter (e.g. CD-BTB200)(sold separately) to AVH-P5350DVD, you can control Bluetooth telephone.

But the available features are limited.

Important

- In some countries, CD-BTB200 is not sold on the market.
- Since this unit is on standby to connect with your cellular phone via Bluetooth wireless technology, using it without the engine running can drain the battery power.
- Advanced operations that require attention such as dialing numbers on the monitor, etc., are prohibited while driving. Park your vehicle in a safe place when using these advanced operations.
- Operations available may be limited depending on the cellular phone connected to this unit.

Touch panel keys

- 

Switching the equalizer curves.
Refer to *Using the equalizer* on page 44.
Touch and hold for more than two seconds to turn the auto-equalizer on or off.
Refer to *Using the auto-equalizer* on page 45.
- 

Accepting an incoming call.
Making a phone call, when selecting a phone number from the dialed and received call history.
- 

Ending a call.
Rejecting an incoming call.
Canceling call waiting.
- 

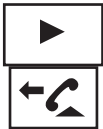
Displaying the received/missed call history.
Selecting a phone number from the call history.
Refer to *Using the missed, received and dialed call lists on the optional Bluetooth adapter* on page 37.
- 

Displaying the dialed call history.
Selecting a phone number from the call history.
Refer to *Using the missed, received and dialed call lists on the optional Bluetooth adapter* on page 37.
- 

Scrolling the phone number.
Touch and hold for more than two seconds to activate connection mode on this unit and establish a Bluetooth wireless connection from your phone.
Refer to *Using a cellular phone to initiate a connection* on page 41.

Using Bluetooth wireless technology

7

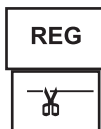

Registering connected cellular phone to take full advantage of the features available with Bluetooth wireless technology.

Refer to *Registering a connected cellular phone* on page 41.

Touch and hold for more than two seconds to terminate the Bluetooth wireless connection.

8



Turning automatic answering on or off.

Refer to *Setting automatic answering* on page 38.

Touch and hold for more than two seconds to connect to a Bluetooth telephone automatically.

Refer to *Connecting to a Bluetooth device automatically* on page 42.

9



Turning the ring tone for incoming calls on or off.

Refer to *Switching the ring tone* on page 38.

Touch and hold for more than two seconds to display the Bluetooth device address of your cellular phone and the Bluetooth adapter.

Refer to *Displaying Bluetooth Device address* on page 42.

10



Switching between Bluetooth telephone and Bluetooth audio.

Touch and hold for more than two seconds to start voice recognition.

Refer to *Voice recognition* on page 42.

1 Connection

First, you need to connect a Bluetooth telephone to this unit.

For detailed instructions on connecting your phone to this unit via Bluetooth wireless technology, see following section. *Using a cellular phone to initiate a connection* on page 41 and *Registering a connected cellular phone* on page 41.

2 Volume adjustment

Adjust the earpiece volume of your cellular phone to your preference. The unit will record the adjusted volume level as the default setting.

- The volume of the caller's voice and ring tone may vary depending on the type of cellular phone.
- If there is a large volume difference between the ring tone and caller's voice, the overall volume level may become unstable.
- Make sure to adjust the volume to a proper level before disconnecting the cellular phone from the unit. If the volume is muted (zero level) on your cellular phone, the volume level of your cellular phone remains muted even after the cellular phone is disconnected.



Bluetooth audio operations

When you connect a Bluetooth adapter (e.g. CD-BTB200)(sold separately) to AVH-P5350DVD, you can control Bluetooth audio.

Important

- Depending on the Bluetooth audio player connected to this unit, the available operations will be limited to the following two levels:
 - A2DP profile (Advanced Audio Distribution Profile): You can only playback songs on your audio player.
 - AVRCP profile (Audio/Video Remote Control Profile): You can perform playback, pause playback, select songs, etc.
- Since there are a number of Bluetooth audio players available on the market, available operations will vary extensively. When operating your player with this unit, refer to the instruction manual that came with your Bluetooth audio player as well as this manual.

Setting up for hands-free phoning

Before you can use the hands-free phoning function you must set up the unit for use with your cellular phone. This entails establishing a Bluetooth wireless connection between this unit and your phone, registering your phone with this unit, and adjusting the volume level.

Using Bluetooth wireless technology

- Information related to a song (such as the elapsed playing time, song title, song index, etc.) cannot be displayed on this unit.
- As the signal from your cellular phone may cause noise, avoid using it when you are listening to songs on your Bluetooth audio player.
- When a call is in progress on the cellular phone connected to this unit via Bluetooth wireless technology, the sound of the Bluetooth audio player connected to this unit is muted.
- When the Bluetooth audio player is in use, you cannot connect to a Bluetooth telephone automatically.
- Playback continues even if you switch from your Bluetooth audio player to another source while listening to a song.

Touch panel keys



Switching between Bluetooth telephone and Bluetooth audio.

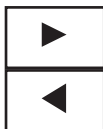

Skipping back or forward to another track when **Auto** is set for the auto/manual setting. Performing fast forward or rewind when **Manual** is set for the auto/manual setting.

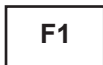

Pausing a song. Touch and hold for more than two seconds to activate connection mode on this unit and establish a Bluetooth wireless connection from your player. Refer to *Connecting a Bluetooth audio player* on page 42.



Playback starts. Touch and hold for more than two seconds to terminate the Bluetooth wireless connection.

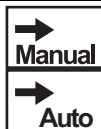

Setting the action for ◀ and ▶ icons.



Switching the equalizer curves. Refer to *Using the equalizer* on page 44. Touch and hold for more than two seconds to turn the auto-equalizer on or off. Refer to *Using the auto-equalizer* on page 45.

Setting up for Bluetooth audio

Before you can use the Bluetooth audio function you must set up the unit for use with your Bluetooth audio player. This entails establishing a Bluetooth wireless connection between this unit and your Bluetooth audio player, and pairing your Bluetooth audio player with this unit.

- Connection
First, you need to connect a Bluetooth audio to this unit. For detailed instructions on connecting your Bluetooth audio to this unit via Bluetooth wireless technology, see *Connecting a Bluetooth audio player* on page 42.

Storing and recalling stations

You can easily store up to six (for tuner)/12 (for TV) stations for each band as presets.

1 Display the preset screen.

Refer to *Introduction of tuner operations* on page 14.

Refer to *Introduction of TV tuner operations* on page 18.

The preset screen appears in the display.

2 Touch and hold one of the preset tuning keys to store the selected frequency in the memory.

The selected radio/TV station frequency has been stored in the memory.

3 Touch one of the preset tuning keys to select the desired station.

Storing the strongest stations

BSM (best stations memory) automatically stores the six (for tuner)/12 (for TV) strongest stations.

Storing broadcast frequencies with BSM may replace broadcast frequencies you have saved using the preset tuning keys.

1 Display the preset screen.

Refer to *Introduction of tuner operations* on page 14.

Refer to *Introduction of TV tuner operations* on page 18.

The preset screen appears in the display.

2 Touch BSM/BSSM to turn BSM on.

The six (for tuner)/12 (for TV) strongest broadcast frequencies will be stored under preset tuning keys in order of their signal strength.

- To cancel the storage process, touch

Cancel. 

Tuning in to strong signals

Local seek tuning lets you tune in to only those radio stations with sufficiently strong signals for good reception.

FM: off — — — — — — — — — — — — — —

AM: off — — — — —

The highest level setting allows reception of only the strongest stations, while lower levels allow the reception of weaker stations. 

Switching the media file type

When playing a disc containing a mixture of various media file types, such as DivX and MP3, you can switch between media file types to play.

Audio data (CD-DA) and JPEG picture files on DVD-R/RW/ROM cannot be played back on this unit.

CD (audio data (CD-DA))—**Music/ROM** (compressed audio)—**Video** (DivX video files)—**Photo** (JPEG picture files) 

Operating the DVD menu

(Function for DVD video)

Some DVDs allow you to make a selection from the disc contents using a menu.

Using the arrow keys

1 Display arrow keys to operate the DVD menu.

Refer to *Playing moving images* on page 15.

Detailed instructions

2 Select the desired menu item.

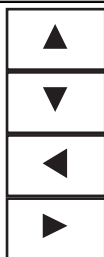

Selecting the desired menu item.



Starting playback from the selected menu item.



Operating the DVD menu by directly touching the menu item.

- When operating the DVD menu by directly touching the menu item, touch the icon to operate.



Returning to the normal DVD video display.



Displaying arrow keys.

- Ways to display the menu will differ depending on the disc.
- Depending on the contents of the DVD disc, this function may not work properly. In such cases, use the touch panel keys to operate the DVD menu.

Operating this unit's iPod function from your iPod

You can listen to the sound from your iPod applications using your car's speakers, when **App Mode** is selected.

This function is not compatible with the following iPod models.

- iPod nano 1st generation
- iPod 5th generation

- While this function is in use, the iPod will not turn off even if the ignition key is turned off. Operate the iPod to turn off the power.

1 Switch the control mode to App Mode.

Refer to *Introduction of video playback operations* on page 15.

Refer to *Introduction of sound playback operations* on page 19.

2 Operate the connected iPod to select a video/song and play.

Notes

- The following functions are still accessible from the unit even if the control mode is set to **App Mode**. However, the operation will depend on your applications.
 - Playing/pausing
 - Fast forwarding/reversing
 - Tracking up/down
 - Moving to a chapter up/down
- APP mode is compatible with the following iPod models.
 - iPhone 4 (software version 4.1 or later)
 - iPhone 3GS (software version 3.0 or later)
 - iPhone 3G (software version 3.0 or later)
 - iPhone (software version 3.0 or later)
 - iPod touch 4th generation (software version 4.1 or later)
 - iPod touch 3rd generation (software version 3.0 or later)
 - iPod touch 2nd generation (software version 3.0 or later)
 - iPod touch 1st generation (software version 3.0 or later)

Random play (shuffle)

Videos/songs can be played back in random order.

- **Songs** – Play back videos/songs in the selected list in random order.
- **Albums** – Play back videos/songs from a randomly selected album in order.

Detailed instructions

- **Folder** – Play back songs/tracks in the selected folder in random order.
- **Disc** – Play back songs/tracks in the selected disc in random order.
- **On** – Play back files in random order within the repeat range, **Folder** and **Disc**.
- **Off** – Cancel random play.

Playing all songs in random order (shuffle all)

(Function for iPod)

This method plays all songs on the iPod randomly.

Repeating playback

- **Disc** – Play through the current disc
 - **Chapter** – Repeat the current chapter
 - **Title** – Repeat the current title
 - **Track** – Repeat the current track
 - **File** – Repeat the current file
 - **Folder** – Repeat the current folder
 - **One** – Repeat just the current video/song/track
 - **All** – Repeat all videos/songs in the selected list on the iPod
Repeat all files
- This function cannot be operated during Video CD playback featuring PBC (playback control).
 - If you perform chapter search, fast forward/reverse, frame-by-frame playback or slow motion playback, the title repeat play will stop.
 - When playing discs with compressed audio and audio data (CD-DA), playback is repeated within the type of data currently playing even if **Disc** is selected.
 - If you select another folder during repeat play, the repeat play range changes to **Disc**. If you select USB or SD source, the repeat play range changes to **All**.

- If you perform track search or fast forward/reverse during **File**, the repeat play range changes to **Folder**.
- If you perform title/chapter search, fast forward/reverse, frame-by-frame playback or slow motion playback during **Chapter**, the repeat play range changes to **OFF**.
- If you perform track search or fast forward/reverse during **Track**, the repeat play range changes to **Disc**.
- When **Folder** is selected, it is not possible to play back a subfolder of that folder.

Playing videos from your iPod

(Function for iPod)

Videos can be played on this unit if an iPod with video capabilities is connected.

- This unit can play back “Movies”, “Music videos”, “Video Podcast” and “TV show” which are downloaded from the iTunes store.
- Before you display the video screen, be sure to change the video setting on the iPod so that the iPod can output the video to an external device.

1 Display the iPod menus.

Refer to *Playing moving images* on page 15.

2 Switch to iPod video mode.



Video

Switching to iPod video mode.

3 Play the video from the iPod.

- If you want to switch to iPod music mode, touch the icon.



Music

Switching to iPod music mode.



Detailed instructions

Browsing for a video/music on the iPod

(Function for iPod)

To make operating and searching easy, operations to control an iPod with this unit are designed to be as similar to the iPod as possible.

Searching for a video/music by category

1 Display the iPod menus.

Refer to *Playing moving images* on page 15.
Refer to *Playing audio* on page 19.

2 Touch one of the categories in which you want to search for a video/music.

- **Video Playlists** (video playlists)
- **Movies** (movies)
- **Music Videos** (music videos)
- **Video Podcasts** (video podcasts)
- **TV Shows** (TV shows)
- **Playlists** (playlists)
- **Artists** (artists)
- **Albums** (albums)
- **Songs** (songs)
- **Podcasts** (podcasts)
- **Genres** (genres)
- **Composers** (composers)
- **Audiobooks** (audiobooks)

3 Touch the title of the list that you want to play.

Repeat this operation until you find the desired video/music.

4 Start playback of the selected list.



Starting playback of the selected list.

Searching the list by alphabet

(Function for iPod)

1 Select a category.

Refer to *Searching for a video/music by category* on this page.

2 Switch to alphabet search mode.



Switching to alphabet search mode.

Alphabet search mode is displayed.

3 Touch the first letter of the title of the video/song you are looking for.

While searching, touch panel key operation is not available.

- To refine the search with a different letter, touch **Cancel**.

4 Touch the title of the list that you want to play.

Repeat this operation until you find the desired song/video.

5 Start playback of the selected list.



Starting playback of the selected list.

Resume playback (Bookmark)

(Function for DVD video)

By using the Bookmark function, you can resume playback from a selected scene the next time the disc is loaded.

The selected scene will be bookmarked so that playback resumes from that point next time.

- To clear the bookmark on a disc, touch and hold the button during playback.
- The oldest bookmark is replaced by the new one. 

Frame-by-frame playback

(Function for DVD video/video CD/DivX file)

Note

Images during frame-by-frame playback may be unclear for some discs. 

Slow motion playback**Notes**

- There is no sound during slow motion playback.
- Images during slow motion playback may be unclear for some discs.
- Reverse slow motion playback is not available. 

Searching for the part you want to play

You can use the search function to find the part you want to play.

For DVD videos, you can select **Title** (title), **Chapter** (chapter) or **10key** (numeric keypad). For video CDs, you can select **Track** (track) or **10key** (numeric keypad).

- Chapter search is not available when disc playback is stopped.
- This function cannot be operated during some DVD videos or Video CD playback featuring PBC (playback control).

1 Start the search function.

Refer to *Playing moving images* on page 15.

2 Touch the desired search option (e.g., Chapter).**3 Touch 0 to 9 to input the desired number.**

- To cancel the entered numbers, touch **C**.

4 Start playback from the selected part.

Registering the numbers and starting playback.

Note

With discs featuring a menu, you can also use the DVD menu to make your selection. Refer to *Playing moving images* on page 15. 

Changing audio language during playback (Multi-audio)

With DVDs/DivX files that provides audio playback in different languages and different audio systems (Dolby Digital, DTS, etc.), you can switch between languages/audio systems during playback.

Notes

- With some DVDs, switching between languages/audio systems may only be possible using a menu display.
- You can also switch between languages/audio systems using **Video Setup** menu. For details, refer to *Setting the audio language* on page 57.
- Only digital output of DTS audio is possible. If the unit's optical digital outputs are not connected, select an audio setting other than DTS.
- Depending on the setting, the video may not be played back with the audio system used to record the DVD.
- You will return to normal playback if you change the **Audio** during fast forward/fast rewind, pause or slow motion playback. 

Changing the subtitle language during playback (Multi-subtitle)

With DVDs/DivX files featuring multi-subtitle recordings, you can switch between subtitle languages during playback.

Notes

- With some DVDs, switching between subtitle languages may only be possible using a menu display.

Detailed instructions

- You can also switch between subtitle languages using **Video Setup** menu. For details, refer to *Setting the subtitle language* on page 57.
- You will return to normal playback if you change the **Subtitle** during fast forward/fast rewind, pause or slow motion playback. 

Changing the viewing angle during playback (Multi-angle)

With DVDs featuring multi-angle (scenes shot from multiple angles) recordings, you can switch among viewing angles during playback.

- During playback of a scene shot from multiple angles, the angle icon is displayed. Use the **Video Setup** menu to turn the angle icon display on or off. For details, refer to *Setting the multi-angle DVD display* on page 58.

Note

You will return to normal playback if you change the viewing angle during fast forward/fast rewind, pause or slow motion playback. 

Return to the specified scene

(Function for DVD video)

This function cannot be used if a specified scene has not been preprogrammed on the DVD disc. 

Selecting audio output

When playing DVD video discs recorded with LPCM audio, you can switch the audio output. When playing video CDs, you can switch between stereo and monaural audio output.

- This function is not available when disc playback is stopped.
- **L+R** – left and right

- **Left** – left
- **Right** – right
- **Mix** – mixing left and right

You may not be able to select or use this function depending on the disc and the playback location. 

PBC playback

(Function for Video CDs)
During playback of Video CDs featuring PBC (Playback Control), **PBC ON** is displayed.

1 Start the search function.

Refer to *Playing moving images* on page 15.

2 Touch 10key to display the numeric keypad.

3 Touch 0 to 9 corresponding to a menu number.

4 Start playback from the selected part.



Registering the numbers and starting playback.

Notes

- You can display the menu by touching **Return** during PBC playback. For details, refer to the instructions provided with the disc.
- PBC playback of a Video CD cannot be canceled.
- During playback of Video CDs featuring PBC (Playback Control), you cannot select the repeat play range or use the search function. 

Selecting tracks from the track title list

You can select tracks to playback using the track title list which is a list of the tracks recorded on a disc.

Detailed instructions

1 Display the track title list.

Refer to *Playing audio* on page 19.

2 Touch your favorite track title.

Playback begins. 

Selecting files from the file name list

(Function for compressed audio/DivX/JPEG)

File name list is a list of file names (or folder names) from which you can select a file (or folder) to play back.

1 Display the file (or folder) name list.

Refer to *Playing audio* on page 19.

Refer to *Introduction of still image playback operations* on page 21.

2 Touch your favorite file (or folder) name.

- When you have selected a folder, a list of the names of the files (or the folders) in it can be viewed. Repeat this operation to select the desired file name.
- If folder **01** (ROOT) contains no files, playback commences with folder **02**.

3 Start playback of the selected list.



Starting playback of the selected list.





Using S.Rtrv (sound retriever)





Automatically enhances compressed audio and restores rich sound.

Off — 

-  is more effective than .





Note

When you use this unit with a multi-channel processor (DEQ-P6600/DEQ-P7650) and switch the advanced sound retriever function to  or ,

the volume will become slightly lower. The volume will become much lower for  than it will for . Take care when you increase the volume for  and then switch to **Off**, because the volume will suddenly seem much louder. 

Changing audiobook speed

(Function for iPod)

-  — Playback at a speed faster than normal
-  — Playback at normal speed
-  — Playback at a speed slower than normal 

Displaying lists related to the currently playing song (Link Search)

(Function for iPod)

1 Start Link Search.

Refer to *Introduction of sound playback operations* on page 19.

2 Touch one of the categories in which you want to play.

- **Artist** — Displays an album list of the artist currently being played.
- **Album** — Displays a song list from the album currently being played.
- **Genre** — Displays an album list from the genre currently being played.
- To cancel searching, touch **Cancel**.

3 Touch the title of the list that you want to play.

4 Start playback of the selected list.



Starting playback of the selected list.



Detailed instructions

Playing DivX® VOD content

Some DivX VOD (video on demand) content may only be playable a fixed number of times. When you load a disc containing this type of content, the remaining number of times it can be played is shown on-screen. You can then decide whether or not to play the disc.

- If there is no limit to the number of times the DivX VOD content can be viewed, then you may load the disc into your player and play the content as often as you like, and no message will be displayed.
- You can confirm the number of times that the content can be played by checking the number displayed after **Remaining Views**:

Important

- In order to play DivX VOD contents on this unit, you first need to register the unit with your DivX VOD contents provider. For details on your registration code, refer to *Displaying the DivX® VOD registration code* on page 60.
- DivX VOD content is protected by a DRM (Digital Rights Management) system. This restricts playback of content to specific, registered devices.

● If a message is displayed after loading a disc containing DivX VOD content, touch **Play**.

Playback of the DivX VOD content will start.

- To skip to the next file, touch **Next Play**.
- If you do not want to play the DivX VOD content, touch **Stop**. 

Capture an image in JPEG files

You can capture image data and use it as wallpaper. Images can be stored and recalled easily in this unit.

- Only one image can be stored on this unit. Old image is overwritten with the new one.

1 Pause the slideshow when the desired image is displayed.

Refer to *Introduction of still image playback operations* on page 21.

Refer to *Introduction of still image playback as a slideshow operations* on page 22.

2 Capture the image.

Refer to *Introduction of still image playback operations* on page 21.

Refer to *Introduction of still image playback as a slideshow operations* on page 22.

3 When Do you save this image? is displayed, touch **Yes**.

While storing the image to this unit, **Saving the image Don't switch off the battery.** is displayed. When the process is finished, **Image saved** is displayed.

- To cancel the storage process, touch **No**. 

Changing the wide screen mode

You can select a desired mode for enlarging a 4:3 picture to a 16:9 picture.

1 Display the screen mode.

Refer to *Introduction of video playback operations* on page 15.

Refer to *Introduction of still image playback operations* on page 21.

Refer to *Introduction of still image playback as a slideshow operations* on page 22.

2 Touch the desired wide mode setting.

Full (full screen)

The 4:3 picture is enlarged in the horizontal direction only, giving you a 4:3 TV picture (normal picture) without any omissions.

Just (just)

The picture is enlarged slightly at the center and the amount of enlargement increases horizontally toward the edges of the screen, enabling you to enjoy a 4:3 picture without sensing any disparity even when viewing on a wide screen.

Cinema (cinema)

The picture is enlarged by the same proportion as **Full** or **Zoom** in the horizontal direction and by an intermediate proportion between **Full** and **Zoom** in the vertical direction; ideal for a cinema-sized picture (wide screen picture) where captions lie outside the picture.

Zoom (zoom)

The 4:3 picture is enlarged in the same proportion both vertically and horizontally; ideal for a cinema sized picture (wide screen picture).

Normal (normal)

The 4:3 picture is displayed as it is, giving you no sense of disparity since its proportions are the same as that of the normal picture.

Notes

- You cannot operate this function while driving.
- Different settings can be stored for each video source.
- When a video is viewed in a wide screen mode that does not match its original aspect ratio, it may appear different.
- Remember that using the wide mode feature of this system for commercial or public viewing purposes may constitute an infringement on the author's rights protected by the Copyright Law.
- The video image will appear coarser when viewed in **Cinema** or **Zoom** mode. 

Calling a number in the phone book

(Function of AVH-P6350BT)

The phone book in your cellular phone will be transferred automatically when the phone is connected to this unit.

After finding the number you want to call in the phone book, you can select the entry and make the call.

1 Switch to phone book mode.

Refer to *Introduction of Bluetooth telephone operations* on page 23.

The phone book display appears.

2 Select the phone number list.

The detailed phone number list of the selected entry is displayed.

3 Select the phone number.

- If you want to store the phone number, touch and hold the list.

4 Make the call.

Refer to *Introduction of Bluetooth telephone operations* on page 23.

5 End the call.

Refer to *Introduction of Bluetooth telephone operations* on page 23.

Note

Depending on the cellular phone, the phone book may not be transferred automatically. In this case, operate your cellular phone to transfer the phone book. The visibility of this unit should be on. Refer to *Switching visible unit* on page 41. 

Selecting a number by alphabet search mode

(Function of AVH-P6350BT)

If a lot of numbers are registered in the phone book, you can search for the phone number by alphabet search mode.

1 Switch to phone book mode.

Refer to *Introduction of Bluetooth telephone operations* on page 23.

The phone book display appears.

Detailed instructions

2 Touch ABC to switch to alphabet search mode.

3 Touch the first letter of the entry you are looking for.

The Phone Book entries starting with that letter (e.g. "Ben", "Brian" and "Burt" when "B" is selected) will be displayed.

- If you want to change the character to Russian, touch the icon. To return to English, touch the icon again.



Changing the character to Russian.

- The order of the first name and last name may be different from that of the cellular phone.

4 Touch the list to display the phone number list of the selected entry.

- If several phone numbers are included in an entry, select one by touching the list.
- If you want to switch to the call history list, touch the icon.



Switching to the call history list.

5 Make the call.

Refer to *Introduction of Bluetooth telephone operations* on page 23.

6 End the call.

Refer to *Introduction of Bluetooth telephone operations* on page 23. 

Using the missed, received and dialed call lists

(Function of AVH-P6350BT)

The 80 most recent calls dialed, received, and missed are stored in the memory. You can browse them and call numbers from these lists.

1 Switch to the call history list.

Refer to *Introduction of Bluetooth telephone operations* on page 23.

2 Select Missed Calls, Dialed Calls or Received Calls.



Displaying the received call list.



Displaying the dialed call list.



Displaying the missed call list.

3 Touch the list number to select a phone number.

Name and phone number are displayed in the detailed list.

- If you want to store the phone number, touch and hold the list.

4 Make the call.

Refer to *Introduction of Bluetooth telephone operations* on page 23.

5 End the call.

Refer to *Introduction of Bluetooth telephone operations* on page 23. 

Using the missed, received and dialed call lists on the optional Bluetooth adapter

(Function of AVH-P5350DVD)

The 80 most recent calls dialed, received, and missed are stored in the memory. You can browse them and call numbers from these lists.

1 Switch to the call history list.

Refer to *Introduction of Bluetooth telephone operations* on page 25.

2 Touch a phone number or name (if entered) you want to call.

Detailed instructions

3 Make the call.

Refer to *Introduction of Bluetooth telephone operations* on page 25.

4 End the call.

Refer to *Introduction of Bluetooth telephone operations* on page 25. 

Setting automatic answering

If this function is on, this unit automatically answers all incoming calls.

● Turn automatic answering on or off.

(AVH-P5350DVD)

Refer to *Introduction of Bluetooth telephone operations* on page 25.

(AVH-P6350BT)

Refer to *Introduction of Bluetooth telephone operations* on page 23. 

Adjusting the other party's listening volume

(Function of AVH-P6350BT)

To maintain the good sound quality, this unit can adjust the other party's listening volume. If the volume is not loud enough for the other party, use this function.

● Select Far-End VOL.

Refer to *Introduction of Bluetooth telephone operations* on page 23.

1—2—3

- This function can be performed even while talking on the phone.
- Settings can be stored for each device. 

Switching the ring tone

You can select whether or not to use this unit's ring tone. If this function is set to on, the ring tone for this unit will sound.

1 Connect your cellular phone to this unit.

2 Turn ring tone on or off.

(AVH-P5350DVD)

Refer to *Introduction of Bluetooth telephone operations* on page 25.

(AVH-P6350BT)

Refer to *Introduction of Bluetooth telephone operations* on page 23. 

Using the preset dial lists

(Function of AVH-P6350BT)

You can easily store up to six phone numbers as presets.

1 Display the preset screen.

Refer to *Introduction of Bluetooth telephone operations* on page 23.

2 Touch one of preset dial keys to select the desired phone number.

- If you want to delete a preset phone number, touch and hold the preset dial key.

3 Make the call.

Refer to *Introduction of Bluetooth telephone operations* on page 23.

4 End the call.

Refer to *Introduction of Bluetooth telephone operations* on page 23. 

Detailed instructions

Making a call by entering phone number

(Function of AVH-P6350BT)

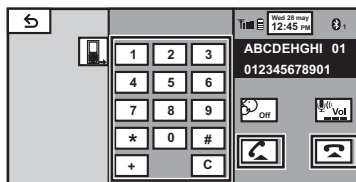

Important

Be sure to park your vehicle in a safe place and apply the parking brake when performing this operation.

1 Switch to the entering phone number mode.

Refer to *Introduction of Bluetooth telephone operations* on page 23.

2 Touch the number icons to input the numbers.

- Up to 24 digits can be entered.

3 Make the call.

Refer to *Introduction of Bluetooth telephone operations* on page 23.

4 End the call.

Refer to *Introduction of Bluetooth telephone operations* on page 23.

Note

Entering phone number mode cannot be operated unless a Bluetooth telephone is connected to this unit.

Setting the private mode

(Function of AVH-P6350BT)

During a conversation, you can switch to private mode (talk directly on your cellular phone).

Refer to *Introduction of Bluetooth telephone operations* on page 23.

Pairing from this unit

(Function of AVH-P6350BT)

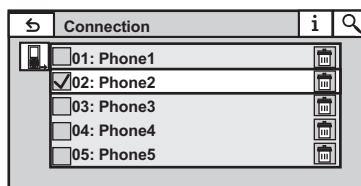

1 Display the Bluetooth Connection Menu.

Refer to *Introduction of Bluetooth telephone operations* on page 23.

2 Touch Connection to select a device.

3 Start to search.



Starting to search.

While searching, is displayed and when available devices are found, the device names or Bluetooth device addresses (if names cannot be obtained) are displayed.

- If you want to switch between the device names and Bluetooth device addresses, touch the icon.



Switching between the device names and Bluetooth device addresses.

- To cancel searching, touch **Stop**.
- If five devices are already paired,

Memory Full is displayed and pairing cannot be performed. In such cases, delete a paired device first. Refer to the next page.

- If no device can be found, **Not Found** is displayed. In such cases, check the status of the Bluetooth device and search again.

4 Touch a device name to select the device you want to connect to.

While connecting, **Pairing** is displayed. If the connection is established, **Paired** is displayed.

- If the connection fails, **Error** is displayed. In such cases, try again from the beginning.

Detailed instructions

- The PIN code is set to **0000** as the default, but can be changed. Refer to *Entering PIN code for Bluetooth wireless connection* on the next page.
 - When establishing connection, the icon is displayed.
- Touch the icon to disconnect the device.



Disconnecting a Bluetooth device.

- If you want to delete a paired Bluetooth telephone, display **Delete OK?**. Touch **Yes** to delete the device.



Deleting a paired device.

- Never turn the unit off while the paired Bluetooth telephone is being deleted.

Using a Bluetooth device to pair

(Function of AVH-P6350BT)

If you cannot open the connection between your Bluetooth device and this unit from your Bluetooth device, you can use this function to establish a connection.

1 Display the Bluetooth Connection Menu.

Refer to *Introduction of Bluetooth telephone operations* on page 23.

2 Touch Special Device to select the special device.

- Bluetooth devices that are difficult to establish a connection with are called special devices. If your Bluetooth device is listed as a special device, select the appropriate one.

3 Touch the special device list to open the connection.

This unit is now on standby for a connection with the Bluetooth device.

- If five devices are already paired, **Memory Full** is displayed and pairing cannot be

performed. In such cases, delete a paired device first. Refer to this page.

4 Use your Bluetooth device to establish a connection.

The connection method is different depending on the Bluetooth device. Refer to the manual for your Bluetooth device to establish a connection.

While connecting, **Pair your phone** is displayed. If the connection is established, **Paired** is displayed.

- If the connection fails, **Error** is displayed. In such cases, try again from the beginning.
 - You may also need to enter a PIN code into this unit. If your telephone requires a PIN code to establish a connection, look for the code on the telephone or in its accompanying documentation.
- The PIN code is set to **0000** as the default, but can be changed. Refer to *Entering PIN code for Bluetooth wireless connection* on the next page.

Connecting to a Bluetooth device automatically

(Function of AVH-P6350BT)

If this function is set to on, a connection between your Bluetooth device and this unit will take place automatically as soon as the two devices are less than a few meters apart. Initially, this function is set to on.

1 Display the Bluetooth Connection Menu.

Refer to *Introduction of Bluetooth telephone operations* on page 23.

2 Touch Auto Connect to turn automatic connection on.

If your Bluetooth device is ready for a Bluetooth wireless connection, a connection to this unit will automatically be established.

- To turn automatic connection off, touch **Auto Connect** again.

3 Turn your vehicle's ACC switch off and on.

Detailed instructions

Switching visible unit

(Function of AVH-P6350BT)

This function sets whether or not to make this unit visible to the other device.

Initially, this function is set to on.

1 Display the Bluetooth Connection Menu.

Refer to *Introduction of Bluetooth telephone operations* on page 23.

2 Touch Visibility to select visibility off.

- To turn visibility on, touch **Visibility** again. 

Displaying Bluetooth Device address

(Function of AVH-P6350BT)

This unit displays its Bluetooth device address.

1 Display the Bluetooth Connection Menu.

Refer to *Introduction of Bluetooth telephone operations* on page 23.

2 Touch Bluetooth Version to display device information.

The Bluetooth device address is displayed. 

Entering PIN code for Bluetooth wireless connection

(Function of AVH-P6350BT)

To connect your Bluetooth device to this unit via Bluetooth wireless technology, you need to enter a PIN code on your Bluetooth device to verify the connection. The default code is **0000**, but you can change it with this function.

1 Display the Bluetooth Connection Menu.

Refer to *Introduction of Bluetooth telephone operations* on page 23.

2 Touch PIN Code Input to select PIN code input.

3 Touch 1 to 0 to input pin code.

4 After inputting PIN code (up to 8 digits), store in this unit.



Storing the PIN code in this unit.



Using a cellular phone to initiate a connection

(Function of AVH-P5350DVD)

A Bluetooth wireless connection can be established from your phone by putting the unit into initiating a connection mode.

You may need to refer to the operation manual that came with your phone if you are unsure how to initiate a connection from your phone.

1 Put the unit in initiating a connection mode.

Refer to *Introduction of Bluetooth telephone operations* on page 25.

2 Use a cellular phone to connect to this unit.

- Operation varies depending on the type of cellular phone.
- You may need to enter the link code on your cellular phone to complete the connection. 

Registering a connected cellular phone

(Function of AVH-P5350DVD)

You can register a phone that is temporarily connected to this unit in order to take full advantage of the features available with Bluetooth wireless technology. Only one cellular phone can be registered.

1 Start registering a connected cellular phone.

Refer to *Introduction of Bluetooth telephone operations* on page 25.

2 Use cellular phone to register to this unit.

If registration is successful, the device name of the connected phone is displayed in the selected assignment.

- If the assignment is already taken, the device name will be displayed. To replace an assignment with a new phone, first delete the current assignment.
- If registration failed, the device name of the connected phone will not be displayed in the selected assignment. In such cases, return to step 1 and try again.

Voice recognition

(Function of AVH-P5350DVD)

If your cellular phone features voice recognition technology, you can make a call by voice commands.

- Operation varies depending on the type of cellular phone. Refer to the instruction manual that came with your cellular phone for detailed instructions.

1 Start voice recognition.

Refer to *Introduction of Bluetooth telephone operations* on page 25.

2 Say the name of your contact aloud.

Connecting a Bluetooth audio player

(Function of AVH-P5350DVD)

A Bluetooth wireless connection can be established by putting the unit into initiating a connection mode.

● Put the unit in initiating a connection mode.

Refer to *Bluetooth audio operations* on page 26.

This unit is now on standby for connection from Bluetooth audio player.

If your Bluetooth audio player is set ready for Bluetooth wireless connection, connection to this unit is automatically established.

Connecting to a Bluetooth device automatically

(Function of AVH-P5350DVD)

If this function is set to on, a connection between your Bluetooth device and this unit will take place automatically as soon as the two devices are less than a few meters apart. Initially, this function is set to on.

1 Touch Auto Connect to turn automatic connection on.

Refer to *Introduction of Bluetooth telephone operations* on page 25.

If your Bluetooth device is ready for a Bluetooth wireless connection, a connection to this unit will automatically be established.

- To turn automatic connection off, touch **Auto Connect** again.

2 Turn your vehicle's ACC switch off and on.

Displaying Bluetooth Device address

(Function of AVH-P5350DVD)

This unit displays its Bluetooth Device address.

● Touch Bluetooth Version to display device information.

Refer to *Introduction of Bluetooth telephone operations* on page 25.

The Bluetooth Device address is displayed.

Menu operations

Introduction of menu operations

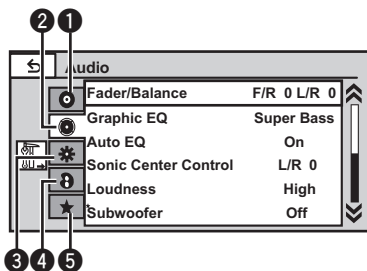





1 Display menus.

Refer to *Common operations for menu settings/lists* on page 12.

2 Touch any of the following touch panel keys to select the menu to be adjusted.

- Touch panel keys

1		Video Setup menu Refer to <i>Setting up the DVD player</i> on page 57.
2		Audio function menu Refer to <i>Audio Adjustments</i> on the next page. DSP function menu Refer to <i>Introduction of DSP adjustments</i> on page 47.
3		System menu Refer to <i>System settings</i> on page 61.
4		Entertainment menu Refer to <i>Entertainment settings</i> on page 68.
5		Custom menu You can choose menus within each menu (Audio function menu, etc.) and register them to this custom menu. Refer to <i>Customizing menus</i> on page 69.

Notes

- If the multi-channel processor (DEQ-P6600/DEQ-P7650) is connected to this unit, the audio function will change according to the

multi-channel processor's audio menu. For details, refer to *Introduction of DSP adjustments* on page 47.

- You can display the **Video Setup** when a **Disc**, **USB** or **SD** source is selected.
- If you start the **Video Setup**, playback is stopped.
- You cannot display the Audio function menu when the mute function is on or a JPEG file is playing. 

Audio Adjustments

Note

When selecting FM as the source, you cannot switch to **Source Level Adjuster**.

Using fader/balance adjustment

You can change the fader/balance setting to provide an ideal listening environment for all of the occupied seats.

1 Display the audio function menu.

Refer to *Introduction of menu operations* on the previous page.

2 Touch Fader/Balance on the audio function menu.

3 Touch ▲ or ▼ to adjust the front/rear speaker balance.

Range: **Front:15 to Rear:15**

- Select **F/R: 0 L/R: 0** when only using two speakers.
- The front/rear speaker balance cannot be adjusted when the rear output setting is

Subwoofer. Refer to *Setting the rear output and subwoofer controller* on page 61.

4 Touch ◀ or ▶ to adjust the left/right speaker balance.

Range: **Left:15 to Right:15**

Using the equalizer

You can adjust the equalization to match the car's interior acoustic characteristics as desired.

Recalling equalizer curves

There are seven stored equalizer curves which you can easily recall at any time. Here is a list of the equalizer curves.

Display	Equalizer curve
Powerful	Powerful
Natural	Natural

Display	Equalizer curve
Vocal	Vocal
Custom1	Custom 1
Custom2	Custom 2
Flat	Flat
Super Bass	Super bass

- The equalizer curves for **Custom1** and **Custom2** can be adjusted.
- You cannot select **Custom1** and **Custom2** when using the auto-equalizer.
- When **Flat**, no changes are made to the sound. You can check the effects of the equalizer curves by switching alternatively between **Flat** and another equalizer curve.

1 Display the audio function menu.

Refer to *Introduction of menu operations* on the previous page.

2 Touch Graphic EQ on the audio function menu.

- You can select **Graphic EQ** when **Auto EQ** function is off.

3 Touch ◀ or ▶ to select the desired item.

Powerful—Natural—Vocal—Custom1—Custom2—Flat—Super Bass

Adjusting the 8-band graphic equalizer

You can adjust the level of each band for the equalizer curves.

- A separate **Custom1** curve can be created for each source. If you make adjustments when a curve other than **Custom2** is selected, the equalizer curve settings will be stored in **Custom1**.
- A **Custom2** curve that is common for all sources can be created. If you make adjustments when the **Custom2** curve is selected, the **Custom2** curve will be updated.

1 Display the audio function menu.

Refer to *Introduction of menu operations* on the previous page.

Menu operations

2 Touch Graphic EQ on the audio function menu.

3 Touch ◀ or ▶ to select the desired item.
Powerful—Natural—Vocal—Custom1—
Custom2—Flat—Super Bass

4 Touch the Equalizer band to adjust.

5 Touch ▲ or ▼ to adjust the level of the equalizer band.

Range: **+12dB to -12dB**

- You can then select another band and adjust the level.

Using the auto-equalizer

The auto-equalizer is an equalizer curve created by auto EQ (refer to *Auto EQ (auto-equalizing)* on page 65).

You can turn the auto-equalizer on or off.

If you connect an optional microphone to this unit, you can use this function.

1 Display the audio function menu.

Refer to *Introduction of menu operations* on page 43.

2 Touch Auto EQ to turn the auto-equalizer on or off.

- You cannot use this function if auto EQ has not been carried out.

Using sonic center control

Sound that is suited for the listening position can easily be created with this function.

1 Display the audio function menu.

Refer to *Introduction of menu operations* on page 43.

2 Touch Sonic Center Control on the audio function menu.

3 Touch ◀ or ▶ to select a listening position.

Range: **Left:7 to Right:7**

Adjusting loudness

Loudness compensates for deficiencies in the low- and high-frequency ranges at low volume.

1 Display the audio function menu.

Refer to *Introduction of menu operations* on page 43.

2 Touch Loudness on the audio function menu.

3 Touch ◀ or ▶ to select a desired level.

Off (off)—Low (low)—Mid (mid)—High (high)

Using subwoofer output

This unit is equipped with a subwoofer output which can be turned on or off.

- The cut-off frequency and output level can be adjusted when the subwoofer output is on.

1 Display the audio function menu.

Refer to *Introduction of menu operations* on page 43.

2 Touch Subwoofer on the audio function menu.

3 Touch On or Off next to Subwoofer to turn the subwoofer output on or off.

4 Touch Normal or Reverse next to Phase to select the phase of subwoofer output.

5 Touch ◀ or ▶ next to Level to adjust the output level of the subwoofer.

Range: **+6 to -24**

6 Touch ◀ or ▶ next to Frequency to select the cut-off frequency.

50Hz—63Hz—80Hz—100Hz—125Hz

Only frequencies lower than those in the selected range are outputted from the subwoofer.

Boosting the bass

You can boost the bass level.

1 Display the audio function menu.

Refer to *Introduction of menu operations* on page 43.

2 Touch ◀ or ▶ to select a desired level.

Range: 0 to +6

Using the high pass filter

When you do not want low sounds from the subwoofer output frequency range to play from the front or rear speakers, turn on the HPF (high pass filter). Only frequencies higher than those in the selected range are output from the front or rear speakers.

1 Display the audio function menu.

Refer to *Introduction of menu operations* on page 43.

2 Touch ◀ or ▶ next to Frequency to select cut-off frequency.

Off (off)—50Hz—63Hz—80Hz—100Hz—125Hz

Only frequencies higher than those in the selected range are output from the front or rear speakers.

Adjusting source levels

With SLA (source level adjustment), the volume levels of each source can be adjusted to prevent significant differences between sources.

- Settings are based on the FM volume level, which remains unchanged.

1 Display the audio function menu.

Refer to *Introduction of menu operations* on page 43.

2 Compare the FM volume level with the level of the source you wish to adjust.

3 Touch Source Level Adjuster on the audio function menu.

4 Touch ▲ or ▼ to adjust the source volume.

Range: +4 to -4

Notes

- The AM volume level can also be adjusted with this function.
- Video CD, CD, compressed audio and DivX are automatically set to the same source level adjustment volume.
- iPod and USB storage device are automatically set to the same source level adjustment volume.
- External unit 1 and external unit 2 are automatically set to the same source level adjustment volume. 

Menu operations

Digital Signal Processor

Introduction of DSP adjustments

You can use this unit to control a DEQ-P6600/DEQ-P7650 multi-channel processor (sold separately).

By carrying out the following settings/adjustments in the order shown, you can effortlessly create a finely-tuned sound field.

- 1 *Setting the speaker setting*
- 2 *Using the position selector*
- 3 *Auto TA and EQ (auto-time alignment and auto-equalizing)*
- 4 *Adjusting time alignment*
- 5 *Adjusting the speaker output levels using a test tone*
- 6 *Selecting a cross-over frequency*
- 7 *Adjusting the speaker output levels*
- 8 *Adjusting the 3-band parametric equalizer*

Notes

- You cannot use the audio functions when playing discs recorded at a sampling frequency higher than 96 kHz. The equalizer curve setting, **Position**, **Auto EQ** and **Auto TA** will also be canceled.
- Sound is only emitted from front speakers when playing discs recorded at a sampling frequency higher than 96 kHz.
- When selecting FM as the source, you cannot switch to **Source Level Adjuster**.
- You can only switch to **Dynamic Range Control** when you are playing DVD discs.
- You can only switch to **Time Alignment** when either **Front-L** or **Front-R** is selected in **Position**.
- When the speaker setting for both the center and rear speakers are set to OFF, you cannot switch to **Dolby Pro Logic II**.
- When the multi-channel processor (DEQ-P6600/DEQ-P7650) is connected to this unit, you cannot use **MUTE** function.

Using the position selector

One way to assure a more natural sound is to optimize the stereo image and place you right in the center of the sound field. With the position selector function, you can automatically adjust the speaker output levels and insert a delay time to match the number and position of the occupied seats. When used in conjunction with the SFC, this feature will make the sound image more natural and offer a panoramic sound that envelops you.

1 Display the DSP function menu.

Refer to *Introduction of menu operations* on page 43.

2 Touch Position on the DSP function menu.

3 Touch ◀/▶/▲/▼ to select a listening position.

Key	Display	Position
◀	Front-L	Left front seat
▶	Front-R	Right front seat
▲	Front	Front seats
▼	All	All seats

- To cancel the selected position, touch the same key again.

Note

When adjustments are made to the listening position, the speaker outputs are automatically set to the appropriate levels. To tailor the levels more precisely, refer to *Adjusting the speaker output levels using a test tone* on page 52 or *Adjusting the speaker output levels* on page 51.

Using fader/balance adjustment

You can change the fader/balance setting to provide an ideal listening environment for all of the occupied seats.

Menu operations

1 Display the DSP function menu.

Refer to *Introduction of menu operations* on page 43.

2 Touch Fader/Balance on the DSP function menu.

3 Touch ▲ or ▼ to adjust the front/rear speaker balance.

Range: **Front:25 to Rear:25**

- Select **F/R: 0 L/R: 0** when only using two speakers.

4 Touch ◀ or ▶ to adjust the left/right speaker balance.

Range: **Left:25 to Right:25**

Using sound field control

The SFC function creates the sensation of a live performance.

- The acoustics of performance spaces differ depending on the extent and contour of space through which sound waves can move and on how the created sounds bounce off the stage, walls, floors and ceilings. At a live performance you hear music in three stages: direct sound, early reflections, and late reflections, or reverberations. These factors are programmed into the SFC circuitry to recreate the acoustics of various performance settings.

1 Display the DSP function menu.

Refer to *Introduction of menu operations* on page 43.

2 Touch SFC on the DSP function menu to select the setting.

Musical(Musical)—**Drama**(Drama)—**Action**(Action)—**Jazz**(Jazz)—**Hall**(Hall)—**Club**(Club)—**Off**(Off)

Note

If the source is a 2-channel LPCM or Dolby Digital audio source, we recommend turning Dolby Pro Logic II on when selecting SFC effects that are most suitable for 5.1-channel audio sources

(such as **Musical**, **Drama** or **Action**).

On the other hand, when selecting SFC effects that are suitable for 2-channel audio sources (such as **Jazz**, **Hall** or **Club**), we recommend turning Dolby Pro Logic II off.

Adjusting source levels

With SLA (source level adjustment), the volume levels of each source can be adjusted to prevent significant differences between sources.

- Settings are based on the FM volume level, which remains unchanged.

1 Compare the FM volume level with the level of the source you wish to adjust.

2 Display the DSP function menu.

Refer to *Introduction of menu operations* on page 43.

3 Touch Source Level Adjuster on the DSP function menu.

4 Touch ▲ or ▼ to adjust the source volume.

Notes

- The AM volume level can also be adjusted with this function.
- Video CD, CD, compressed audio and DivX are automatically set to the same source level adjustment volume.
- External unit 1 and external unit 2 are automatically set to the same source level adjustment volume.

Menu operations

Using dynamic range control

The dynamic range refers to the difference between the smallest and largest sounds emitted. Dynamic range control compresses this difference so that the sounds can be heard clearly even at low volume levels.

- The dynamic range control is only effective for Dolby Digital sound.
- You can only switch to **Dynamic Range Control** when you are playing DVD discs.

1 Display the DSP function menu.

Refer to *Introduction of menu operations* on page 43.

2 Touch Dynamic Range Control on the DSP function menu.

3 Touch ► to turn dynamic range control on.

- To turn dynamic range control off, touch ◀.

Using the down-mix function

Multi-channel audio can be played back in 2-channels with the down-mix function.

1 Display the DSP function menu.

Refer to *Introduction of menu operations* on page 43.

2 Touch Down Mix on the DSP function menu.

3 Touch ◀ or ► to select the desired level.

- **Lo/Ro** – Stereo mixing the original audio data that does not contain channel modes such as surround sound components.
- **Lt/Rt** – Down mixing so that the surround sound components can be restored (decoded).

Using direct control

You can override the audio settings to check their effectiveness.

- When direct control is on, all audio functions except **MUTE** and **Dolby Pro Logic II** are locked.

1 Display the DSP function menu.

Refer to *Introduction of menu operations* on page 43.

2 Touch Digital Direct on the DSP function menu.

3 Touch ► to turn the direct control on.

- To turn direct control off, touch ◀.

Using Dolby Pro Logic II

Dolby Pro Logic II creates five full-bandwidth output channels from two-channel sources to achieve high-purity matrix surround sound.

- Dolby Pro Logic II supports stereo sources with a sampling rate of up to 48 kHz and has no effect on other types of sources.
- When the speaker setting for both the center and rear speakers are set to OFF, you cannot switch to **Dolby Pro Logic II**.

1 Display the DSP function menu.

Refer to *Introduction of menu operations* on page 43.

2 Touch Dolby Pro Logic II.

3 Touch any of the following touch panel keys to select the desired mode.

- **Movie** – Suitable for movie playback
- **Music** – Suitable for music playback
- **Matrix** – Suitable when FM radio reception is weak
- **Music Adjust** – Enables adjusting the Music mode
- **Off** – Turns Dolby Pro Logic II off
 - You can only operate **Music Adjust** when **Music** has been selected.

Adjusting the music mode

You can adjust the music mode with the following three controls.

Menu operations

- Panorama (**Panorama**) extends the front stereo image to include the surround speakers for an exciting “wraparound” effect.
- Dimension (**Dimension**) gradually adjusts the sound field either towards the front or rear.
- Center width control (**Center Width**) positions center-channel sounds between the center, left and right speakers. It improves the left-center-right stage presentation for both the driver and front passenger.

1 Display the DSP function menu.

Refer to *Introduction of menu operations* on page 43.

2 Touch Dolby Pro Logic II.

3 Touch Music and then touch Music Adjust.

- You can only operate **Music Adjust** when **Music** has been selected.

4 Touch ▲ or ▼ to select Panorama (panorama).

Panorama (panorama)—**Dimension** (dimension)—**Center Width** (center width)

5 Touch ► to turn panorama control on.

- To turn panorama control off, touch ◀.

6 Touch ▼ to select Dimension and then touch ◀ or ► to adjust the front/rear speaker balance.

Range: +3 to -3

7 Touch ▼ to select Center Width and then touch ◀ or ► to adjust the center image.

Range: 0 to 7

The default setting is **3** and is recommended for most recordings. When set to **0**, all center sound is placed in the center speaker. When set to **7**, center sound is equally placed in the left and right speakers.

Setting the speaker setting

Be sure to adjust the speaker settings, such as size (bass capacity), according to the speakers installed. Set the size to **Large** (large) if the speaker is capable of reproducing sounds of about 100 Hz and below. Otherwise, select **Small** (small).

- Low frequency sound is not emitted if the subwoofer is set to **Off** and the front and rear speakers are set to **Small** or **Off**.
- It is imperative that speakers that are not installed be set to **Off**.
- Set the front or rear speaker to **Large** if the speaker is capable of reproducing bass content, or if no subwoofer is installed.

1 Display the DSP function menu.

Refer to *Introduction of menu operations* on page 43.

2 Touch Speaker Setting.

3 Touch ▲ or ▼ to select the speaker to be adjusted.

Front (front speakers)—**Center** (center speaker)—**Rear** (rear speakers)—**Subwoofer** (subwoofer)—**Phase** (subwoofer setting)

- You can only switch to **Phase** when the subwoofer has been set to **On**.

4 Touch ◀ or ► to select the correct size for the selected speaker.

Off (off)—**Small** (small)—**Large** (large)

- You cannot select **Off** when **Front** (front speakers) has been selected.
- You can select **On** or **Off** when **Subwoofer** (subwoofer) has been selected.
- You can switch **Reverse** (reverse phase) or **Normal** (normal phase) when **Phase** (subwoofer setting) has been selected.

Correcting the subwoofer's phase

If boosting the bass output from the subwoofer is not effective or you feel that the bass is becoming less clear, the subwoofer output and bass content emitted from the other speakers may be canceling each other out.

Menu operations

1 Display the DSP function menu.

Refer to *Introduction of menu operations* on page 43.

2 Touch Speaker Setting.

3 Touch ▲ or ▼ to select Subwoofer (subwoofer).

Front (front speakers)—**Center** (center speaker)—**Rear** (rear speakers)—**Subwoofer** (subwoofer)—**Phase** (subwoofer setting)

4 Touch ► to turn subwoofer output on.

- To turn subwoofer output off, touch ◀.

5 Touch ▼ and then touch ◀ or ► to select the phase of subwoofer output.

Reverse—**Normal**

Note

When playing a 2-channel mono source with Dolby Pro Logic II turned on:

- No sound is emitted if the center speaker setting is **Small** or **Large** and no center speaker is installed.
- Sound is only emitted through the center speaker if it is installed and set to **Small** or **Large**.

Adjusting the speaker output levels

Fine adjustments of the speaker output level can be made by listening to audio output. First, use the test tone to adjust the speaker to an approximate level, and then use this function to make fine adjustments.

1 Display the DSP function menu.

Refer to *Introduction of menu operations* on page 43.

2 Touch Speaker Level.

3 Touch ▲ or ▼ to select the speaker to be adjusted.

Front-L (left front speaker)—**Center** (center speaker)—**Front-R** (right front speaker)—

Rear-R (right rear speaker)—**Rear-L** (left rear speaker)—**Subwoofer** (subwoofer)

- Speakers with the size set to **Off** cannot be selected. (Refer to *Setting the speaker setting* on the previous page.)

4 Touch ◀ or ► to adjust the speaker output level.

Range: **+10** to **-10**

Note

You will get the same results whether you adjust the speaker output levels with this mode or with **Test Tone**.

Selecting a cross-over frequency

The frequency under which sounds are reproduced through a subwoofer can be selected. For example, if the size of one of the installed speakers is set to **Small**, you can select the frequency under which sounds will be reproduced through a speaker set to **Large** or a subwoofer.

1 Display the DSP function menu.

Refer to *Introduction of menu operations* on page 43.

2 Touch Cross Over.

3 Touch ▲ or ▼ to select the speaker to be adjusted.

Front (front speakers)—**Center** (center speaker)—**Rear** (rear speakers)—**Subwoofer** (subwoofer)

4 Touch ◀ or ► to select the cross-over frequency.

63Hz—**80Hz**—**100Hz**—**125Hz**—**160Hz**—**200Hz**

Note

When you select a cross-over frequency, you are setting the cross-over frequency for the subwoofer's L.P.F. (low-pass filter) and the **Small** speaker's H.P.F. (high-pass filter). The cross-over frequency setting has no effect if the subwoofer is set to **Off** and other speakers are set to **Large** or **Off**.

Adjusting the speaker output levels using a test tone

You can easily get the right overall balance among the speakers with this function.

1 Display the DSP function menu.

Refer to *Introduction of menu operations* on page 43.

2 Touch Test Tone.**3 Touch Start to start test tone output.**

The test tone is emitted from each speaker in the following sequence at intervals of about two seconds. The current settings for the speaker emitting the test tone will be shown on the display.

Front-L (left front speaker)—**Center** (center speaker)—**Front-R** (right front speaker)—**Rear-R** (right rear speaker)—**Rear-L** (left rear speaker)—**Subwoofer** (subwoofer)

Check each speaker output level. If no adjustments are needed, perform step 5 to stop the test tone.

- The settings for speakers with the size set to **Off** will not be displayed. (Refer to *Setting the speaker setting* on page 50.)

4 Touch ◀ or ▶ to adjust the speaker output level.

Range: **+10** to **-10**

- The test tone will be emitted from the next speaker after about two seconds after the last operation.

5 Touch Stop to end test tone output.**Notes**

- If necessary, select speakers and adjust their 'absolute' output levels. (Refer to *Adjusting the speaker output levels* on the previous page.)
- You will get the same results whether you adjust the speaker output levels with this mode or with **Speaker Level**.

Using time alignment

The distance between the listening position and each speaker can be adjusted with this function.

1 Display the DSP function menu.

Refer to *Introduction of menu operations* on page 43.

2 Touch Time Alignment.**3 Touch any of the following touch panel keys to select the time alignment.**

- **Initial** – Initial time alignment (factory setting)
- **Auto TA** – Time alignment created by auto TA and EQ. (Refer to *Auto TA and EQ (auto-time alignment and auto-equalizing)* on page 54.)
- **Custom** – Adjusted time alignment that you can create
- **TA Adjust** – Enables adjusting the time alignment as desired
- **Off** – Turns Time Alignment off
- You cannot select **Auto TA** if auto TA and EQ have not been carried out.
- **TA Adjust** can only be selected when either **Front-L** or **Front-R** is selected in **Position**.

Adjusting time alignment

The distance between the selected position and each speaker can be adjusted.

- The adjusted time alignment is stored in **Custom**.

Menu operations

1 Display the DSP function menu.

Refer to *Introduction of menu operations* on page 43.

2 Touch Time Alignment and then touch TA Adjust.

▪ **TA Adjust** can only be selected when either **Front-L** or **Front-R** is selected in **Position**.

3 Touch ▲ or ▼ to select the speaker to be adjusted.

Front-L (left front speaker)—**Center** (center speaker)—**Front-R** (right front speaker)—**Rear-R** (right rear speaker)—**Rear-L** (left rear speaker)—**Subwoofer** (subwoofer)

▪ Speakers with the size set to **Off** cannot be selected. (Refer to *Setting the speaker setting* on page 50.)

4 Touch ◀ or ▶ to adjust the distance between the selected speaker and the listening position.

Range: **0.0cm** to **500.0cm**

Using the equalizer

You can adjust the equalization to match the car's interior acoustic characteristics as desired.

Recalling equalizer curves

There are seven stored equalizer curves which you can easily recall at any time. Here is a list of the equalizer curves.

Display	Equalizer curve
Powerful	Powerful
Natural	Natural
Vocal	Vocal
Flat	Flat
Custom1	Custom 1
Custom2	Custom 2
Super Bass	Super bass

- The equalizer curves for **Custom1** and **Custom2** can be adjusted.
- When **Flat**, no changes are made to the sound. You can check the effects of the equalizer curves by switching alternatively between **Flat** and another equalizer curve.
- When **Digital Direct** is on, the equalizer curve is fixed to **Flat**.

1 Display the DSP function menu.

Refer to *Introduction of menu operations* on page 43.

2 Touch Parametric EQ.

3 Touch ▲ or ▼ to select the Equalizer (equalizer).

4 Touch ▶ to select the equalizer.

Powerful—**Natural**—**Vocal**—**Flat**—**Custom1**—**Custom2**—**Super Bass**

Adjusting the 3-band parametric equalizer

For **Custom1** and **Custom2** equalizer curves, you can adjust the front, rear and center equalizer curves separately by selecting a center frequency, an equalizer level and a Q factor for each band.

- A separate **Custom1** curve can be created for each source.
- A **Custom2** curve that is common for all sources can be created.
- The center speaker largely determines the sound image and getting the balance right is not easy. We recommend that you first adjust the balance among all of the speakers except the center speaker, by playing 2-channel audio (a CD, for example). Then, play 5.1-channel audio (Dolby Digital or DTS) and adjust the center speaker output to match the balance already created among the other speakers.

1 Display the DSP function menu.

Refer to *Introduction of menu operations* on page 43.

2 Touch Parametric EQ.

3 Touch ▲ or ▼ to select the desired item.
Equalizer (equalizer)—**SP-Select** (speakers)—
Band (bands)—**Frequency** (center frequency)
 —**Level** (equalizer level)—**Q. Factor** (Q factor)

4 Touch ► to select the equalizer.
Powerful—**Natural**—**Vocal**—**Flat**—**Custom 1**
 —**Custom 2**—**Super Bass**

5 Touch ▼ and then touch ◀ or ▶ to select the speaker to be adjusted.
Rear (rear speakers)—**Center** (center speaker)
 —**Front** (front speakers)

- Speakers with the size set to **Off** cannot be selected. (Refer to *Setting the speaker setting* on page 50.)

6 Touch ▼ and then touch ◀ or ▶ to select the equalizer band to be adjusted.
Low (low)—**Mid** (mid)—**High** (high)

7 Touch ▼ and then touch ◀ or ▶ to select the center frequency of selected band.
40Hz—50Hz—63Hz—80Hz—100Hz—125Hz
—160Hz—200Hz—250Hz—315Hz—400Hz
—500Hz—630Hz—800Hz—1kHz—1.25kHz
—1.6kHz—2kHz—2.5kHz—3.15kHz—4kHz
—5kHz—6.3kHz—8kHz—10kHz—12.5kHz

8 Touch ▼ and then touch ◀ or ▶ to adjust the equalizer level.
 Range: **+12** to **-12**

9 Touch ▼ and then touch ◀ or ▶ to select the desired Q factor.
Narrow (narrow)—**Wide** (wide)

- Adjust the parameters of each band for the other speakers in the same way.

Note

A center frequency can be selected for each band and can be changed in 1/3-octave steps. However, the interval between the selected center frequencies cannot be shorter than 1 octave.

Using the auto-equalizer

The auto-equalizer is the equalizer curve created by auto TA and EQ (refer to *Auto TA and EQ (auto-time alignment and auto-equalizing)* on this page).

You can turn the auto-equalizer on or off.

1 Display the DSP function menu.

Refer to *Introduction of menu operations* on page 43.

2 Touch Auto EQ.

- You cannot use this function if auto TA and EQ have not been carried out.

3 Touch ► to turn the auto-equalizer on.

- To turn the auto-equalizer off, touch ◀.

Auto TA and EQ (auto-time alignment and auto-equalizing)

Auto-time alignment automatically adjusts the time alignment according to the distance between the listening position and each speaker. The auto-equalizer automatically measures the car's interior acoustic characteristics, and then creates an auto-equalizer curve based on that information.

**WARNING**

As a loud tone (noise) may be emitted from the speakers when measuring the car's interior acoustic characteristics, never perform auto TA or auto EQ while driving.

**CAUTION**

- Thoroughly check the conditions before performing auto TA and EQ as the speakers may be damaged if these functions are performed when:
 - The speakers are incorrectly connected. (For example, when a rear speaker is connected as a subwoofer output.)
 - A speaker is connected to a power amp delivering output higher than the speaker's maximum input power capability.

Menu operations

- If the microphone is placed in an unsuitable position the measurement tone may become loud and measurement may take a long time, resulting in battery drainage. Be sure to place the microphone in the specified location.

Before operating the auto TA and EQ function

- Perform auto TA and EQ in a quiet place, with both the car engine and air conditioning switched off. Also turn off any car phones or portable telephones in the car, or remove them from the car. Sounds other than the measurement tone (such as surrounding sounds, engine sound, telephones ringing) may prevent correct measurement of the car's interior acoustic characteristics.
- Be sure to perform auto TA and EQ using the optional microphone. Using another microphone may prevent measurement, or result in incorrect measurement of the car's interior acoustic characteristics.
- In order to perform auto TA and EQ, the front speaker must be connected.
- When this unit is connected to a power amp with input level control, auto TA and EQ may not be possible if the power amp's input level is set below the standard level.
- When this unit is connected to a power amp with an LPF, turn this LPF off before performing auto TA and EQ. Also set the cut-off frequency for the built-in LPF of an active subwoofer to the highest frequency.
- The time alignment value resulting from auto TA and EQ has been calculated by a computer and is the optimum delay time that will give accurate results. Be sure to use the resulting value although it may differ from the actual distance when:
 - The reflected sound within the car is strong and delays occur.
 - The LPF on active subwoofers or external amps delay the lower sounds.
- Auto TA and EQ changes the audio settings as follows:

- The fader/balance settings return to the center position. (Refer to *Using fader/balance adjustment* on page 47.)
- The equalizer curve switches to **Flat**. (Refer to *Recalling equalizer curves* on page 44.)
- The front, center and rear speakers will automatically be adjusted to a high pass filter setting.

- Previous settings for auto TA and EQ will be overwritten.

Performing auto TA and EQ

For details concerning operation, refer to the operation manual for the multi-channel processor.

1 Stop the car in a place that is quiet, close all the doors, windows and sun roof, and then turn the engine off.

If the engine is left running, engine noise may prevent correct auto EQ.

2 Fix the optional microphone in the center of the headrest of the driver's seat, facing forward.

The auto EQ may differ depending on where you place the microphone. If desired, place the microphone on the front passenger seat to carry out auto EQ.

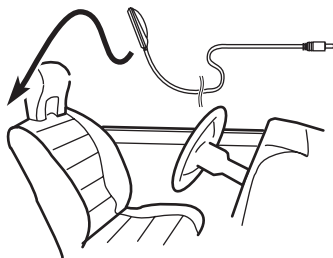

3 Turn the ignition switch to ON or ACC.

If the car's air conditioner or heater is turned on, turn it off. Noise from the fan in the air conditioner or heater may prevent correct auto EQ.

Menu operations

- If this unit is turned off, press **SRC/OFF** to turn the source on.

4 Select the position for the seat on which the microphone is placed.

Refer to *Using the position selector* on page 47.

- If no position is selected before you start auto EQ, **Front-L** is selected automatically.

5 Turn the unit off.

Refer to *Basic operations of this unit* on page 11.

6 Display the system menu.

Refer to *Introduction of menu operations* on page 43.

7 Touch Auto EQ&TA Measurement to enter auto EQ and TA measurement mode.

8 Plug the microphone into the microphone input jack.

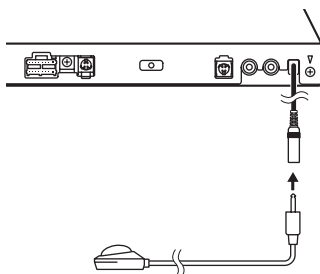

9 Touch Start to start auto EQ.

10 When the 10-second countdown starts, get out of the car and close the door within 10 seconds.

A measurement tone (noise) is emitted from the speakers, and auto EQ measurement begins.

When auto EQ is completed, **Complete** is displayed.

When the car's interior acoustic characteristics cannot be measured correctly, an error message will be displayed. (Refer to *Under-*

standing auto EQ/auto TA and EQ error messages on page 94.)

- It takes about nine minutes for auto EQ measurement to be completed when all the speakers are connected.
- To stop auto EQ, touch **Stop**.
- To cancel auto EQ measurement mode during this procedure, touch the following touch panel key.



Canceling auto EQ measurement mode.

11 Store the microphone carefully in the glove compartment or another safe place.

If the microphone is subjected to direct sunlight for an extended period, high temperatures may cause distortion, color change or malfunction. 

Menu operations

Setting up the DVD player

Setting the subtitle language

You can set a desired subtitle language. When available, the subtitles will be displayed in the selected language.

1 Display the Video Setup menu.

Refer to *Introduction of menu operations* on page 43.

2 Touch Subtitle Language on the Video Setup menu.

A subtitle language menu is displayed.

3 Touch the desired language.

The subtitle language is set.

- If you have selected **Others**, refer to *When you select Others* on this page.

Notes

- If the selected language is not available, the language specified on the disc is displayed.
- You can also switch the subtitle language by touching the icon during playback. (Refer to *Playing moving images* on page 15.)
- The setting made here will not be affected even if the subtitle language is switched during playback using **Subtitle**.

When you select Others

A language code input display is shown when **Others** is selected. Refer to *Language code chart for DVD* on page 104.

1 Touch 0 to 9 to input the language code.

- To cancel the entered numbers, touch **C**.

2 Registering the code.



Registering the code.

Setting the audio language

You can set the preferred audio language.

1 Display the Video Setup menu.

Refer to *Introduction of menu operations* on page 43.

2 Touch Audio Language on the Video Setup menu.

An audio language menu is displayed.

3 Touch the desired language.

The audio language is set.

- If you have selected **Others**, refer to *When you select Others* on this page.

Notes

- If the selected language is not available, the language specified on the disc is used.
- You can also switch the audio language by touching **Audio** during playback. (Refer to *Playing moving images* on page 15.)
- The setting made here will not be affected even if the audio language is switched during playback using **Audio**.

Setting the menu language

You can set the preferred language in which the menus recorded on a disc are displayed.

1 Display the Video Setup menu.

Refer to *Introduction of menu operations* on page 43.

2 Touch Menu Language on the Video Setup menu.

A menu language menu is displayed.

3 Touch the desired language.

The menu language is set.

- If you have selected **Others**, refer to *When you select Others* on this page.

Note

If the selected language is not available, the language specified on the disc is displayed.

Setting the multi-angle DVD display

The angle icon can be set so it appears on scenes where the angle can be switched.

1 Display the Video Setup menu.

Refer to *Introduction of menu operations* on page 43.

2 Touch Multi Angle on the Video Setup menu to turn angle icon display on or off.

Setting the aspect ratio

There are two kinds of display: a wide screen display that has a width-to-height ratio (TV aspect ratio) of 16:9, and regular display that has a TV aspect of 4:3. Be sure to select the correct TV aspect for the display connected to **REAR MONITOR OUTPUT**.

- When using regular display, select either **Letter Box** or **Pan Scan**. Selecting **16:9** may result in an unnatural picture.
- If you select the TV aspect ratio, the unit's display will change to the same setting.

1 Display the Video Setup menu.

Refer to *Introduction of menu operations* on page 43.

2 Touch TV Aspect on the Video Setup menu to select the TV aspect ratio.

Touch **TV Aspect** repeatedly until the desired aspect ratio appears.

- **16:9** – Wide screen picture (16:9) is displayed as is (initial setting)
- **Letter Box** – The picture is the shape of a letterbox with black bands on the top and bottom of the screen
- **Pan Scan** – The picture is cut short on the right and left sides of the screen

Notes

- When playing discs that do not specify **Pan Scan**, the disc is played back in **Letter Box** display even if you select the

Pan Scan setting. Confirm whether the disc package bears the **16:9 LB** mark.

- The TV aspect ratio cannot be changed for some discs. For details, refer to the disc's instructions.

Setting the slide show interval

JPEG files can be viewed as a slide show on this unit. In this setting, the interval between each image can be set.

1 Display the Video Setup menu.

Refer to *Introduction of menu operations* on page 43.

2 Touch Time Per Photo Slide on the Video Setup menu to select the slide show interval.

Touch **Time Per Photo Slide** repeatedly until the desired setting appears.

- **5sec** – JPEG images switch at intervals of 5 seconds
- **10sec** – JPEG images switch at intervals of 10 seconds
- **15sec** – JPEG images switch at intervals of 15 seconds
- **Manual** – JPEG images can be switched manually

Setting parental lock

Some DVD video discs let you use parental lock to restrict children from viewing violent and adult-oriented scenes. You can set parental lock to the desired level.

- When you have a parental lock level set and play a disc featuring parental lock, code number input indications may be displayed. In such cases, playback will begin when the correct code number is entered.

Menu operations

Setting the code number and level

A code number must be registered in order to play back discs with parental lock.

1 Display the Video Setup menu.

Refer to *Introduction of menu operations* on page 43.

2 Touch Parental on the Video Setup menu.

3 Touch 0 to 9 to input a four digit code number.

- To cancel the entered numbers, touch **C**.

4 Registering the code.



Registering the code.

The code number is set, and the level can now be set.

5 Touch 1 to 8 to select the desired level.

6 Touch Enter.

The parental lock level is set.

- **8** – Playback of the entire disc is possible (initial setting)
- **7 to 2** – Playback of discs for children and non-adult-oriented discs is possible
- **1** – Playback of discs for children only is possible

Notes

- We recommend to keep a record of your code number in case you forget it.
- The parental lock level is stored on the disc. Look for the level indication written on the disc package, included literature or on the disc itself. Parental lock of this unit is not possible if a parental lock level is not stored on the disc.
- With some discs, the parental lock may be active only for certain levels of scenes. The playback of those scenes will be skipped. For details, refer to the instruction manual that came with the disc.

Changing the level

You can change the set parental lock level.

1 Display the Video Setup menu.

Refer to *Introduction of menu operations* on page 43.

2 Touch Parental on the Video Setup menu.

3 Touch 0 to 9 to input the registered code number.

4 Registering the code.



Registering the code.

This sets the code number, and the level can now be changed.

- If you enter an incorrect code number, the  icon is displayed. Touch **C** and enter the correct code number.
- If you forget your code number, refer to *If you forget your code number* on this page.

5 Touch 1 to 8 to select the desired level.

6 Touch Enter.

The new parental lock level is set.

If you forget your code number

Press **RESET**.

Setting the DivX subtitle file

You can select whether or not to display DivX external subtitles.

- The DivX subtitles will be displayed even when **Custom** is selected if no DivX external subtitle files exist.

1 Display the Video Setup menu.

Refer to *Introduction of menu operations* on page 43.

2 Touch DivX Subtitle on the Video Setup menu to select the desired subtitle setting.

- **Original** – Display the DivX subtitles
- **Custom** – Display the DivX external subtitles

Notes

- Up to 42 characters can be displayed on one line. If more than 42 characters are set, the line breaks and the characters are displayed on the next line.
- Up to 126 characters can be displayed on one screen. If more than 126 characters are set, the excess characters will not be displayed.

Displaying the DivX® VOD registration code

In order to play DivX VOD (video on demand) contents on this unit, the unit must first be registered with a DivX VOD contents provider. For registration, generate a DivX VOD registration code and submit it to your provider.

- Keep a record of the code as you will need it when you register your unit to the DivX VOD provider.

1 Display the Video Setup menu.

Refer to *Introduction of menu operations* on page 43.

2 Touch DivX VOD on the Video Setup menu.

Registration Code and **Deregistration Code** appear.

3 Touch Registration Code.

Your registration code is displayed.

Displaying the deregistration code

If your device is already activated, deregister it by entering the deregistration code.

1 Display the Video Setup menu.

Refer to *Introduction of menu operations* on page 43.

2 Touch DivX VOD on the Video Setup menu.

3 Touch Deregistration Code.

- To cancel deregistration, touch **Cancel**.

4 Touch OK.

The deregistration is complete.

Setting for digital output

Audio which is outputted from digital output of this unit can be selected. Normally, set to **Stream**. If this unit's digital output is not used, there is no need to change settings.

1 Display the Video Setup menu.

Refer to *Introduction of menu operations* on page 43.

2 Touch Digital Output on the Video setup menu to select the desired digital output setting.

- **Stream** – The Dolby Digital/DTS signal is output as it is (initial setting)
- **Linear PCM** – The Dolby Digital/DTS signal is converted to and output as a linear PCM signal

Automatic playback of DVDs

When a DVD disc with a DVD menu is inserted, this unit will cancel the menu automatically and start playback from the first chapter of the first title.

- Some DVDs may not operate properly. If this function is not fully operated, turn this function off and start playback.

1 Display the Video Setup menu.

Refer to *Introduction of menu operations* on page 43.

2 Touch DVD Auto Play to turn automatic playback on.

- To turn automatic playback off, touch **DVD Auto Play** again. 

Menu operations

System settings

Switching the auxiliary setting

Activate this setting when using an auxiliary device connected to this unit.

1 Display the system menu.

Refer to *Introduction of menu operations* on page 43.

2 Touch AUX Input on the system menu to turn AUX Input on or off.

Setting AV input

Activate this setting when using an external video component connected to this unit.

1 Display the system menu.

Refer to *Introduction of menu operations* on page 43.

2 Touch AV Input on the system menu to turn AV Input on or off.

Setting the rear output and subwoofer controller

This unit's rear output (rear speaker leads output and RCA rear output) can be used for full-range speaker (**Full**) or subwoofer (**Subwoofer**) connection. If you switch the rear output setting to **Subwoofer**, you can connect a rear speaker lead directly to a subwoofer without using an auxiliary amp. Initially, the unit is set for a rear full-range speaker connection (**Full**).

- When the DEQ-P6600/DEQ-P7650 multi-channel processor is connected to this unit, you cannot operate this function.

1 Turn the unit off.

Refer to *Basic operations of this unit* on page 11.

2 Display the system menu.

Refer to *Introduction of menu operations* on page 43.

3 Touch Rear Speaker on the system menu to switch the subwoofer output or full-range speaker.

- When no subwoofer is connected to the rear output, select **Full** (full-range speaker).
- When a subwoofer is connected to the rear output, select **Subwoofer** (subwoofer).

Notes

- Even if you change this setting, there will be no output unless you turn the subwoofer output on (refer to *Using subwoofer output* on page 45).
- If you change this setting, subwoofer output in the audio menu will return to the factory settings.
- Both rear speaker lead outputs and RCA rear output are switched simultaneously in this setting.

Setting the FM tuning step

- The tuning step remains at 50 kHz during manual tuning.

1 Turn the unit off.

Refer to *Basic operations of this unit* on page 11.

2 Display the system menu.

Refer to *Introduction of menu operations* on page 43.

3 Touch FM Step on the system menu to select the FM tuning step.

Touching **FM Step** will switch the FM tuning step between 50 kHz and 100 kHz. The selected FM tuning step will appear.

Setting the AM tuning step

● Touch AM Step on the initial menu to select the AM tuning step.

Touching **AM Step** will switch the AM tuning step between 9 kHz and 10 kHz. The selected AM tuning step will appear in the display.

Switching sound muting/attenuation

Sound from this system is automatically muted or attenuated when a signal from equipment with a mute function is received.

- Sound from this system returns to normal when the muting or attenuation is canceled.

1 Display the system menu.

Refer to *Introduction of menu operations* on page 43.

2 Touch Mute/ATT until the desired setting appears.

Touch **Mute/ATT** until the desired setting appears in the display.

- **Mute** – Muting
- **ATT –20dB** – Attenuation (**ATT –20dB** has a stronger effect than **ATT –10dB**)
- **ATT –10dB** – Attenuation
- **Off** – Turns the sound muting/attenuation off

Notes

- When **Mute** is displayed, the sound is turned off and no audio adjustments can be made.
- When **ATT** is displayed, the sound is attenuated and only the volume can be adjusted. (No other audio adjustments can be made.)
- Operation returns to normal when the phone connection is ended.

Selecting the menu language

The menu language can be selected from four languages.

- The language can be changed for the following:
 - System menu
 - Video Setup
 - On-screen display
 - Multi language setting for DivX
 - Language for cautions
 Some operations on this unit are prohibited from use while driving or require careful attention when operated. In such cases, a caution will appear on the display. You can change the language for caution messages with this setting.

- If the embedded language and the selected language setting are not the same, text information may not display properly.
- Some characters may not be displayed properly.

1 Display the system menu.

Refer to *Introduction of menu operations* on page 43.

2 Touch System Language on the system menu to select the desired language.

3 Touch the desired language.

- **English** (English)—ไทย (Thai)—Español (Spanish)—Português (Portuguese) for South American and Oceanian models
- **English** (English)—Русский (Russian)—العربية (Arabic)—فارسی (Persian) for Middle East Asian and South African models

Clearing Bluetooth memory

(Function of AVH-P6350BT)

Important

Never turn the unit off while the Bluetooth memory is being cleared.

1 Turn the unit off.

Refer to *Basic operations of this unit* on page 11.

2 Display the system menu.

Refer to *Introduction of menu operations* on page 43.

3 Touch Bluetooth Memory Clear on the system menu.

4 Touch Reset.

After selecting a desired item, a confirmation display appears. Touch **Reset** to delete the memory.

- If you do not want to clear the memory, touch **Cancel**.

Updating Bluetooth connection software

(Function of AVH-P6350BT)

Menu operations

This function is used to update this unit with the latest software. For information on the software and updating, refer to our website.

Important

Never turn the unit off and never disconnect the phone while the software is being updated.

1 Turn the unit off.

Refer to *Basic operations of this unit* on page 11.

2 Display the system menu.

Refer to *Introduction of menu operations* on page 43.

3 Touch Bluetooth Software Update.

4 Touch Start to display the data transfer mode.

- Follow the on-screen instructions to finish updating the software.

Displaying the Bluetooth system version

(Function of AVH-P6350BT)

If this unit fails to operate properly, you may need to consult your dealer for repair. In such cases, you may be asked to specify the system version. Perform the following procedure to check the version on this unit.

1 Turn the unit off.

Refer to *Basic operations of this unit* on page 11.

2 Display the system menu.

Refer to *Introduction of menu operations* on page 43.

3 Touch Bluetooth Version Information to display to the version of the Bluetooth module of this unit.

Setting the automatic open function

To prevent the display from hitting the shift lever of an automatic vehicle when it is in the **P** (park) position, or when you do not wish the display to open/close automatically, you can

set the automatic open function to manual mode.

1 Display the system menu.

Refer to *Introduction of menu operations* on page 43.

2 Touch Auto Flap to select whether to open/close the display automatically or manually.

Each time you touch **Auto Flap** the setting switches between:

- On** – The LCD panel will open or close automatically when the ignition switch is turned on or off.
- Off** – You have to press **OPEN/CLOSE** to open/close the LCD panel.

Adjusting the LCD panel slide position

You can adjust the LCD panel slide position so that the panel is set back or forward.

1 Display the system menu.

Refer to *Introduction of menu operations* on page 43.

2 Touch Flap Set Back.

3 Touching the Flap Set Back keys allows you to move the LCD panel back and forth.



The LCD panel slides to the back.



The LCD panel slides to the front.

Adjusting the LCD panel angle

Important

- If you can hear the LCD panel knocking against your vehicle's console or dashboard, touch and hold **OPEN/CLOSE** to temporarily level the LCD panel.

Menu operations

- When adjusting the LCD panel angle, be sure to touch and hold **OPEN/CLOSE**. Forcibly adjusting the LCD panel by hand may damage it.



1 Display the system menu.

Refer to *Introduction of menu operations* on page 43.

2 Touch Display Tilt.

3 Touch the Display Tilt keys to adjust the LCD panel to an easily viewable angle.

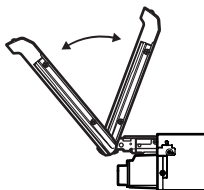

Laying the panel down.



Returning the panel to the upright position.

- As the set angle is saved, the LCD panel will automatically be adjusted to the same position the next time the LCD panel is opened.

Switching the warning tone

If the front panel is not detached from the head unit within four seconds of turning off the ignition, a warning tone sounds. You can turn off the warning tone.

1 Display the system menu.

Refer to *Introduction of menu operations* on page 43.

2 Touch DT.WARNING to turn the warning tone on.

- To turn the warning tone off, touch **DT.WARNING** again.

Setting the rear view camera (back up camera)

⚠ CAUTION

Pioneer recommends the use of a camera which outputs mirror-reversed images. Otherwise, the screen image will appear reversed.

This unit features a function that automatically switches to the rear view camera video (**REAR VIEW CAMERA IN**) when a rear view camera is installed on your car and the gear shift is moved to the **REVERSE (R)** position. (For more details, consult your dealer.)

- After you set up the rear view camera setting, move the gear shift to **REVERSE (R)** and confirm that the rear view camera video is shown on the display.
- Change this setting if the display switches to the rear view camera video by error while you are driving forward.
- To stop watching the rear view camera video and return to the source display, press and hold **MUTE/⏏**.
- Touch the **RearView** source icon to display the rear view camera image while driving. Touch the source icon again to turn the rear view camera off. For details, refer to *Selecting a source using the touch panel keys* on page 11.

1 Display the system menu.

Refer to *Introduction of menu operations* on page 43.

2 Touch Camera Polarity on the system menu to select the appropriate setting.

- Battery** – When the polarity of the connected lead is positive while the gear shift is in **REVERSE (R)** position

Menu operations

- **Ground** – When the polarity of the connected lead is negative while the gear shift is in **REVERSE (R)** position
- **Off** – When a rear view camera is not connected to this unit

Selecting the video format

You can switch the video output format of **REAR MONITOR OUTPUT** between NTSC and PAL.

1 Display the system menu.

Refer to *Introduction of menu operations* on page 43.

2 Touch Video Output Format on the system menu to select the video output format.

NTSC—PAL

Note

You can switch the video output format only for the source from this unit.

Setting the video signal

When you connect this unit to an AV equipment to this unit, select the suitable video signal setting.

- As this function is initially set to **Auto**, the unit will automatically adjust the video signal setting.
However, the screen may turn black or images may not be displayed properly when **Auto** has been selected and the reception is weak. Normally, select the appropriate TV signal.
- About your country TV signal, consult with your nearest Pioneer dealer.
- You can operate this function only for the video signal input into the AV input.

1 Display the system menu.

Refer to *Introduction of menu operations* on page 43.

2 Touch Video Signal Setting on the function menu.

Video Signal Setting items are displayed.

- **AV** – Adjusts the AV video signal
- **AUX** – Adjusts the AUX video signal

- **Camera** – Adjusts the camera video signal
- **TV** – Adjusts the TV video signal

3 Touch ◀ or ▶ to select the desired video signal appears.

Auto—PAL—NTSC—PAL-M—PAL-N—SECAM

Selecting the area group

1 Select the TV source.

Refer to *Basic operations of this unit* on page 11.

2 Display the system menu.

Refer to *Introduction of menu operations* on page 43.

3 Touch TV Country Group on the function menu.

4 Touch ◀ or ▶ until the desired area group appears.

Country1 (CCIR channel)—**Country2** (IN channel)—**Country3** (CHN channel)—**Country4** (U.K. channel)—**Country5** (OIRT channel)—**Country6** (AUSTRALIA channel)—**Country7** (SAF channel)

Auto EQ (auto-equalizing)

The auto-equalizer automatically measures the car's interior acoustic characteristics, and then creates an auto-equalizer curve based on that information.

WARNING

As a loud tone (noise) may be emitted from the speakers when measuring the car's interior acoustic characteristics, never perform auto EQ while driving.

CAUTION

- Thoroughly check the conditions before performing auto EQ as the speakers may be damaged if these functions are performed when:
 - The speakers are incorrectly connected.
(For example, when a rear speaker is connected as a subwoofer output.)

Menu operations

- A speaker is connected to a power amp delivering output higher than the speaker's maximum input power capability.
- If the microphone is placed in an unsuitable position the measurement tone may become loud and measurement may take a long time, resulting in battery drainage. Be sure to place the microphone in the specified location.
 - The equalizer curve switches to **Flat**. (Refer to *Recalling equalizer curves* on page 44.)
 - The front, center and rear speakers will automatically be adjusted to a high pass filter setting.
- Previous settings for auto EQ will be overwritten.

Before operating the auto EQ function

- Carry out auto EQ in as quiet a place as possible, with the car engine and air conditioning switched off. Also cut power to car phones or portable telephones in the car, or remove them from the car before carrying out auto EQ. Sounds other than the measurement tone (surrounding sounds, engine sound, telephones ringing etc.) may prevent correct measurement of the car interior acoustic characteristics.
- Be sure to carry out auto EQ using the optional microphone. Using another microphone may prevent measurement, or result in incorrect measurement of the car interior acoustic characteristics.
- In order to perform auto EQ, the front speaker must be connected.
- When this unit is connected to a power amp with input level control, auto EQ may not be possible if the power amp's input level is set below the standard level.
- When this unit is connected to a power amp with an LPF, turn this LPF off before performing auto EQ. Also set the cut-off frequency for the built-in LPF of an active subwoofer to the highest frequency.
- The distance has been calculated by computer to be the optimum delay to give accurate results for the circumstances, so please continue to use this value.
 - The reflected sound within the car is strong and delays occur.
 - The LPF on active subwoofers or external amps delay the lower sounds.
- Auto EQ changes the audio settings as follows:
 - The fader/balance settings return to the center position. (Refer to *Using fader/balance adjustment* on page 44.)

Performing auto EQ

1 Stop the car in a place that is quiet, close all the doors, windows and sun roof, and then turn the engine off.

If the engine is left running, engine noise may prevent correct auto EQ.

2 Fix the optional microphone in the center of the headrest of the driver's seat, facing forward.

The auto EQ may differ depending on where you place the microphone. If desired, place the microphone on the front passenger seat to carry out auto EQ.

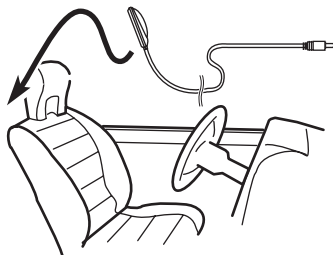

3 Turn the ignition switch to ON or ACC.

If the car's air conditioner or heater is turned on, turn it off. Noise from the fan in the air conditioner or heater may prevent correct auto EQ.

4 Display the system menu.

Refer to *Introduction of menu operations* on page 43.

5 Touch Auto EQ Measurement to enter auto EQ measurement mode.

Menu operations

- 6 Plug the microphone into the microphone input jack on this unit.**

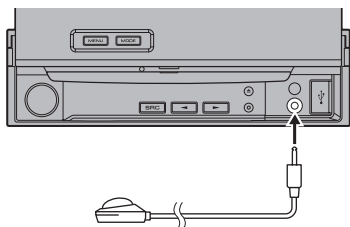

- 7 Touch Start to start auto EQ.**

- 8 When the 10-second countdown starts, get out of the car and close the door within 10 seconds.**

A measurement tone (noise) is emitted from the speakers, and auto EQ measurement begins.

When auto EQ is completed, **Complete** is displayed.

When the car's interior acoustic characteristics cannot be measured correctly, an error message will be displayed. (Refer to *Understanding auto EQ/auto TA and EQ error messages* on page 94.)

- It takes about nine minutes for auto EQ measurement to be completed when all the speakers are connected.
- To stop auto EQ, touch **Stop**.
- To cancel auto EQ measurement mode during this procedure, touch the following touch panel key.



Canceling auto EQ measurement mode.

- 9 Store the microphone carefully in the glove compartment or another safe place.**

If the microphone is subjected to direct sunlight for an extended period, high temperatures may cause distortion, color change or malfunction.

Note

Do not press ▲ (eject) to open or close the panel when you are using the microphone.

Correcting distorted sound

When listening to a CD or other source on which the recording level is high, setting the level of each frequency to high may result in distortion. You can switch the digital attenuator to low to reduce distortion.

- Sound quality is better at the high setting so this setting is usually used.

- 1 Display the system menu.**

Refer to *Introduction of menu operations* on page 43.

- 2 Touch Digital ATT.**

- 3 Touch Digital ATT on the system menu to select the digital attenuator level. High—Low**

Resetting the audio functions

You can reset all audio functions.

- 1 Display the system menu.**

Refer to *Introduction of menu operations* on page 43.

- 2 Touch Audio Reset.**

- 3 Touch Reset .**

Ready to reset. Are you sure? appears in the display.

- To cancel this function on the way, touch **Cancel**.

- 4 Touch Reset again.**

The reset end was carried out. appears in the display and audio functions are reset. ■

Entertainment settings

Selecting the illumination color

This unit is equipped with multiple-color illumination.

Direct selection from preset illumination colors

You can select an illumination color from the color list.

1 Display the entertainment menu.

Refer to *Introduction of menu operations* on page 43.

2 Touch Appearance.

3 Touch Illumination and then touch a color on the list.

Customizing the illumination color

1 Display the entertainment menu.

Refer to *Introduction of menu operations* on page 43.

2 Touch Appearance.

3 Touch Illumination and then touch Custom.

4 Display the customizing menu.



Displaying the customizing menu.

5 Touch the color bar to customize the color.

6 Touch ◀ or ▶ to fine-tune the color.

7 Touch the icon and hold to store the customized color in the memory.



Storing the customized color in the memory.

The customized color has been stored in the memory.

The set color will be recalled from the memory the next time you touch the same icon.

Selecting the OSD color

The OSD color can be changed.

1 Display the entertainment menu.

Refer to *Introduction of menu operations* on page 43.

2 Touch Appearance.

3 Touch Screen.

4 Touch one of the colors on the list.

Selecting the background display

You can switch the background that is displayed when listening to a source.

1 Display the entertainment menu.

Refer to *Introduction of menu operations* on page 43.

2 Touch Background.

3 Touch the desired setting.

- If no JPEG images are stored in this unit, you cannot select photo. To store a JPEG image to this unit, refer to *Capture an image in JPEG files* on page 35. 

Menu operations

Customizing menus

1 Display menu columns to register.

Refer to *Introduction of menu operations* on page 43.

You can customize menus except

Video Setup menu.

2 Touch and hold the menu column to register it.

- To cancel registration, touch and hold the menu column again.

3 Display the custom menu and choose a registered menu.

Refer to *Introduction of menu operations* on page 43.

Notes

- You can register up to 12 columns.
- If you register a column from the Audio function menu, the registration will be cancelled when a DEQ-P6600/DEQ-P7650 multi-channel processor is connected.
- If you register a column from the DSP menu, the registration will be canceled when the DEQ-P6600/DEQ-P7650 multi-channel processor is disconnected.

Changing the picture adjustment

You can adjust the **Brightness** (brightness), **Contrast** (contrast), **Color** (color) , **Hue** (hue), **Dimmer** (dimmer), **Temperature** (temperature), **Black Level** (black level) and **RGB Dot Adjust** (RGB dot clock adjustment) for each source and rear view camera.

- You cannot adjust **Color**, **Hue**, **Black Level** and **RGB Dot Adjust** for the audio source.

1 Press and hold MENU to display Picture Adjustment.

The adjustment function names are displayed.

2 If you are adjusting the Picture Adjustment, select the unit.

NAVI

Adjusting the **Picture Adjustment** for the Navigation system.

Rear View

Adjusting the **Picture Adjustment** for the rear view camera.

Source

Adjusting the **Picture Adjustment** for the source.

3 Touch any of the following touch panel keys to select the function to be adjusted.

Picture Adjustment items are displayed.

- Brightness** – Adjusts the black intensity
- Contrast** – Adjusts the contrast
- Color** – Adjusts the color saturation
- Hue** – Adjusts the tone of color (red or green is emphasized)
- Dimmer** – Adjusts the brightness of the display
- Temperature** – Adjusts the color temperature, resulting in a better white balance
- Black Level** – Emphasizes the dark portions of images making the difference between bright and dark more distinct
- RGB Dot Adjust** – Adjusts phase shifting by dot clock when a Navigation system is connected

- You cannot adjust the picture adjustment for the rear view camera when **Camera Polarity** is set to **Off**. (Refer to *Setting the rear view camera (back up camera)* on page 64.)
- You can adjust **Hue** only when the color system is set to NTSC.
- With some rear view cameras, picture adjustment may not be possible.

4 Touch ◀ or ▶ to adjust the selected item.

Each time you touch ◀ or ▶, the level of the selected item increases or decreases.

- Dimmer** can be adjusted from **+1** to **+48**.
- Temperature** can be adjusted from **+3** to **-3**.

5 Touch Black Level and RGB Dot Adjust to adjust.

- Black Level** can be set on or off.
- RGB Dot Adjust** can be set to **1** or **2**.

Notes

- You cannot operate this function while driving.
- Different **Brightness/Contrast/Dimmer** settings can be set for when the illumination switch is on and when it is off. 

Setting rear monitor output

The output source for the rear monitor can be switched to the following:

- Front** – The source on the front screen of this unit
- Disc** – The video and sound from the DVD
- AV** – The video and sound from AV input
- AUX** – The source for AUX input
- Off** – No source

Note

You cannot play DivX files on the rear and front monitors at the same time. 

Adjusting the response positions of the touch panels (Touch Panel Calibration)

If you feel that the touch panel keys on the screen deviate from the actual positions that respond to your touch, adjust the response positions of the touch panel. There are two adjustment methods: 4-point adjustment, in which you touch four corners of the screen; and 16-point adjustment, in which you make fine-adjustments on the entire screen.

- Touch the screen gently for adjustment. Forcefully pressing the touch panel may damage the touch panel. Do not use a sharp pointed tool such as a ballpoint pen or mechanical pen. Doing so may damage the screen.
- If the touch panel cannot be adjusted properly, consult your local Pioneer dealer.

1 Turn the unit off.

Refer to *Basic operations of this unit* on page 11.

2 Press and hold MENU to display Picture Adjustment.

3 Press and hold MENU to start Touch Panel Calibration.

The 4-point touch panel adjustment screen appears.

4 Touch each of the arrows on the four corners of the screen.

- To cancel the adjustment, press and hold **MENU**.

5 Press MENU to complete 4-point adjustment.

Data for the adjusted position is saved.

- Do not turn off the engine while the data is being saved.

6 Press MENU to proceed to 16-point adjustment.

The 16-point touch panel adjustment screen appears.

- To cancel the adjustment, press and hold **MENU**.

7 Gently touch the center of the + mark displayed on the screen.

After you touch all the marks, the data for the adjusted position is saved.

- Do not turn off the engine while the data is being saved.

8 Press and hold MENU to complete the adjustment.

Using an AUX source

A separately sold auxiliary device such as a VCR or portable device can be connected to this unit. When connected, the auxiliary device is automatically recognized as an AUX source and is assigned to **AUX**.

About AUX connection methods

You can connect auxiliary devices to this unit.

Mini pin plug cable (AUX)

When connecting an auxiliary device using a mini plug cable

iPods and portable audio/video players can be connected to this unit via mini plug cable.

- If an iPod with video capabilities is connected to this unit via 3.5 mm plug (4 pole) cable (such as the CD-V150M), you can enjoy the video contents of the connected iPod.
- A portable audio/video player can be connected by using a 3.5 mm plug (4 pole) with an RCA cable (sold separately). However, depending on the cable, a reverse connection between the red (right side audio) cable and yellow (video) cable may be required in order for the sound and video image to be reproduced correctly.

● **Insert the stereo mini plug into the AUX input jack on this unit.**

Refer to *What's what* on page 9. 

Using an external unit

An external unit refers to a Pioneer product, such as those which will be available in the future. Although incompatible as a source, the basic functions of up to two external units can be controlled with this unit. When two external units are connected, the external units are automatically allocated to external unit 1 or external unit 2.

The basic operations of the external unit are explained below. The allocated functions will differ depending on the connected external unit. For details concerning these functions, refer to the owner's manual for the external unit.

Basic operations

The functions allocated to the following operations will differ depending on the connected external unit. For details concerning these functions, refer to the owner's manual for the connected external unit.



Switching to auto or manual.



Switching to video and audio.



Changing the screen mode.
Refer to *Changing the wide screen mode* on page 35.



Switching the equalizer curves.
Refer to *Using the equalizer* on page 44.
Touch and hold for more than two seconds to turn the auto-equalizer on or off.
Refer to *Using the auto-equalizer* on page 45.



Actions will differ depending on the connected external unit.

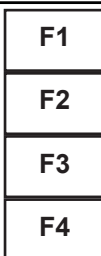

Function 1 to 4
Actions will differ depending on the connected external unit.



Using the functions allocated to 1 to 6 keys.
Actions will differ depending on the connected external unit.



Installation

Connecting the units

WARNING

- To avoid the risk of accident and the potential violation of applicable laws, no viewing of front seat video should ever occur while the vehicle is being driven. Also, rear displays should not be in a location where they are visibly distracting to the driver.
- In some countries or states the viewing of images on a display inside a vehicle even by persons other than the driver may be illegal. Where such regulations apply, they must be obeyed and this unit's DVD features should not be used.

CAUTION

- PIONEER does not recommend that you install or service your display unit yourself. Installing or servicing the product may expose you to risk of electric shock or other hazards. Refer all installation and servicing of your display unit to authorized Pioneer service personnel.
- Secure all wiring with cable clamps or electrical tape. Do not allow any bare wiring to remain exposed.
- Do not drill a hole into the engine compartment to connect the yellow cable of the display unit to the vehicle battery. Engine vibration may eventually cause the insulation to fail at the point where the wire passes from the passenger compartment into the engine compartment. Take extra care in securing the wire at this point.
- It is extremely dangerous to allow the microphone lead to become wound around the steering column or gearstick. Be sure to install the unit in such a way that it will not obstruct driving.
- Make sure that cables will not interfere with moving parts of the vehicle, such as the gearshift, parking brake or seat sliding mechanism.
- Do not shorten any cables. If you do, the protection circuit may fail to work properly.

WARNING

- **LIGHT GREEN LEAD AT POWER CONNECTOR IS DESIGNED TO DETECT PARKED STATUS AND MUST BE CONNECTED TO THE POWER SUPPLY SIDE OF THE PARKING BRAKE SWITCH. IMPROPER CONNECTION OR USE OF THIS LEAD MAY VIOLATE APPLICABLE LAW AND MAY RESULT IN SERIOUS INJURY OR DAMAGE.**

WARNING

- Use speakers over 50 W (output value) and between 4 Ω to 8 Ω (impedance value). Do not use 1 Ω to 3 Ω speakers for this unit.
- The black cable is ground. When installing this unit or power amp (sold separately), make sure to connect the ground wire first. Ensure that the ground wire is properly connected to metal parts of the car's body. The ground wire of the power amp and the one of this unit or any other device must be connected to the car separately with different screws. If the screw for the ground wire loosens or falls out, it could result in fire, generation of smoke or malfunction.

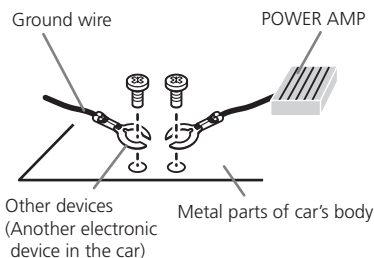

Installation

⚠ Important

- This unit cannot be installed in a vehicle without ACC (accessory) position on the ignition switch.



ACC position



No ACC position

- Use this unit with a 12-volt battery and negative grounding only. Failure to do so may result in a fire or malfunction.
- To prevent a short-circuit, overheating or malfunction, be sure to follow the directions below.
 - Disconnect the negative terminal of the battery before installation.
 - Secure the wiring with cable clamps or adhesive tape. Wrap adhesive tape around wiring that comes into contact with metal parts to protect the wiring.
 - Place all cables away from moving parts, such as the gear shift and seat rails.
 - Place all cables away from hot places, such as near the heater outlet.
 - Do not connect the yellow cable to the battery by passing it through the hole to the engine compartment.
 - Cover any disconnected cable connectors with insulating tape.
 - Do not shorten any cables.
 - Never cut the insulation of the power cable of this unit in order to share the power with other devices. The current capacity of the cable is limited.
 - Use a fuse of the rating prescribed.
 - Never wire the negative speaker cable directly to ground.
 - Never band together negative cables of multiple speakers.
- When this unit is on, control signals are sent through the blue/white cable. Connect this cable to the system remote control of an external power amp or the vehicle's auto-antenna relay control terminal (max. 300 mA 12 V DC). If the vehicle is equipped with a glass anten-

na, connect it to the antenna booster power supply terminal.

- Never connect the blue/white cable to the power terminal of an external power amp. Also, never connect it to the power terminal of the auto antenna. Doing so may result in battery drain or a malfunction.
- IP-BUS connectors are color-coded. Be sure to connect connectors of the same color.

Connecting the power cord

Wired remote input (**WIRED REMOTE INPUT**)

Hard-wired remote control adaptor can be connected (sold separately).

Microphone input Jack (**MIC**)
(AVH-P6350BT only)

Microphone (supplied)
(AVH-P6350BT only)

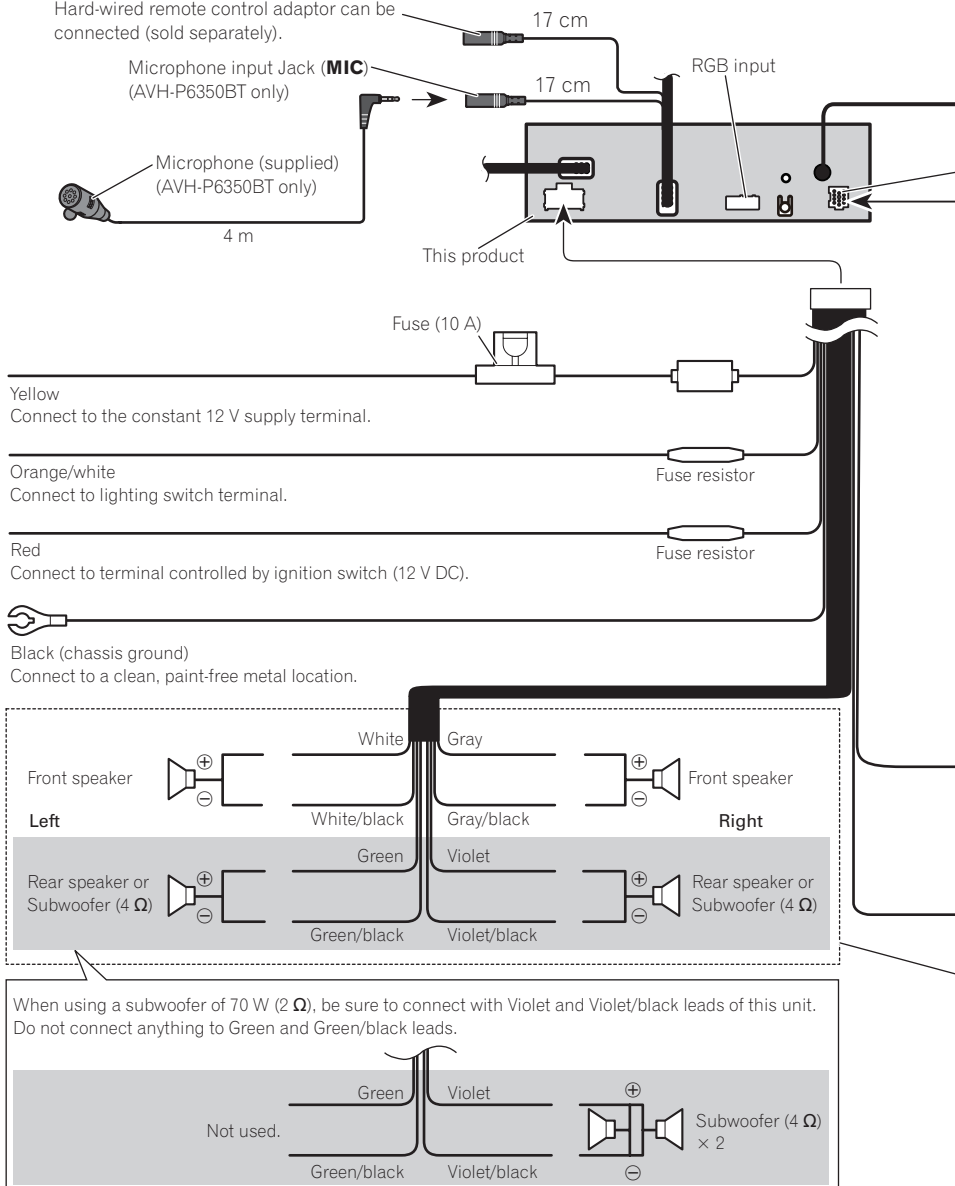

Installation

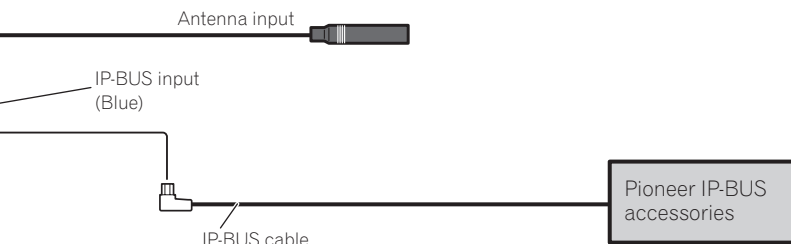

Connection method



1. Clamp the lead.

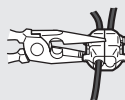

2. Clamp firmly with needle-nosed pliers.

Note:

- The position of the parking brake switch depends on the vehicle model. For details, consult the vehicle Owner's Manual or dealer.

Light green

Used to detect the ON/OFF status of the parking brake. This lead must be connected to the power supply side of the parking brake switch.

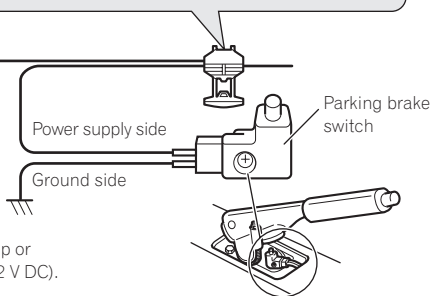

Blue/white

Connect to system control terminal of the power amp or auto-antenna relay control terminal (max. 300 mA 12 V DC).

With a 2 speaker system, do not connect anything to the speaker leads that are not connected to speakers.

When you connect the separately sold multi-channel processor (e.g., DEQ-P6600/DEQ-P7650) to this unit, do not connect anything to the speaker leads and system remote control (blue/white).

Note:

- Change the initial setting of this unit. The subwoofer output of this unit is monaural.

When connecting to separately sold power amp

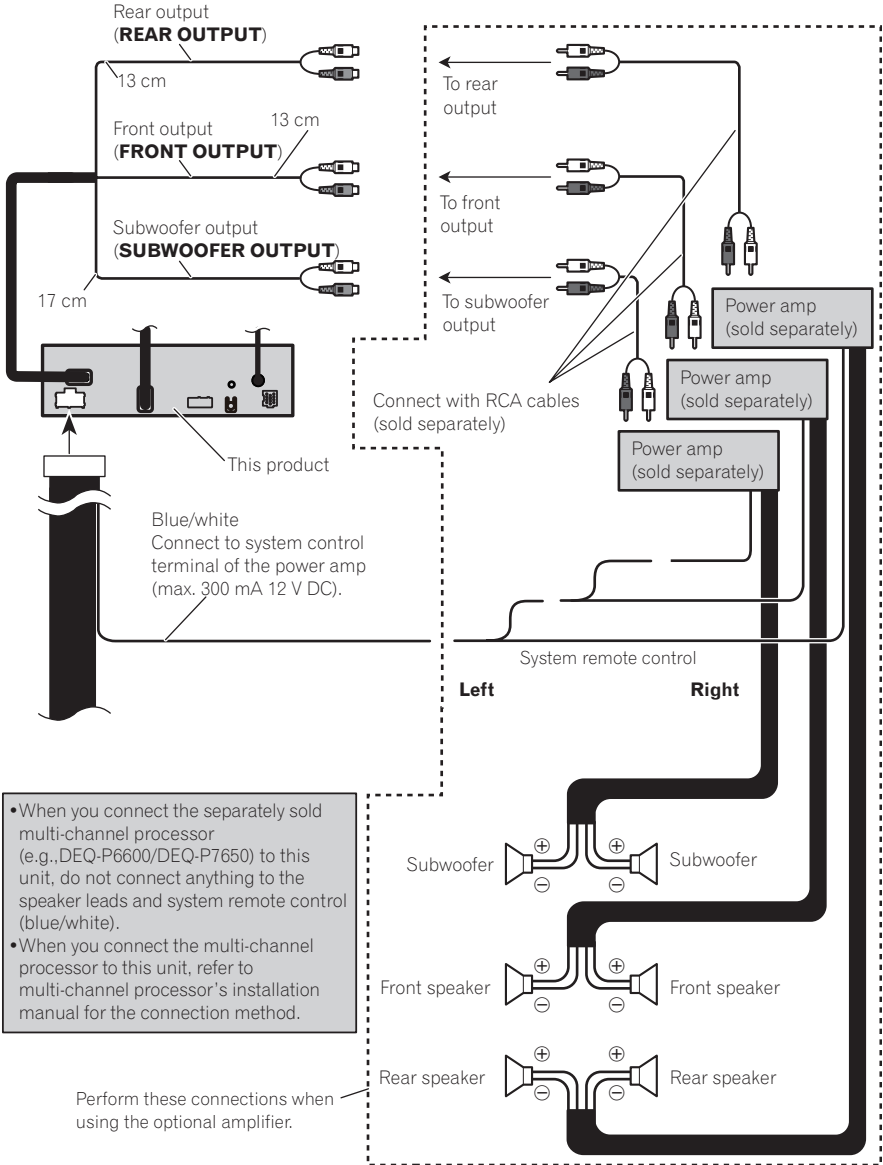

- When you connect the separately sold multi-channel processor (e.g., DEQ-P6600/DEQ-P7650) to this unit, do not connect anything to the speaker leads and system remote control (blue/white).
- When you connect the multi-channel processor to this unit, refer to multi-channel processor's installation manual for the connection method.

Perform these connections when using the optional amplifier.

Installation

Connecting the system (for AVH-P5350DVD model)

Wired remote input (**WIRED REMOTE INPUT**)

Hard-wired remote control adaptor can be connected (sold separately).

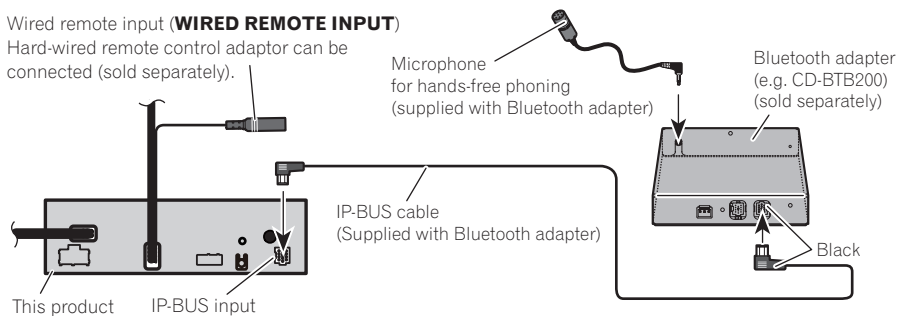

Connecting the system (for AVH-P6350BT model)

Wired remote input (**WIRED REMOTE INPUT**)

Hard-wired remote control adaptor can be connected (sold separately).

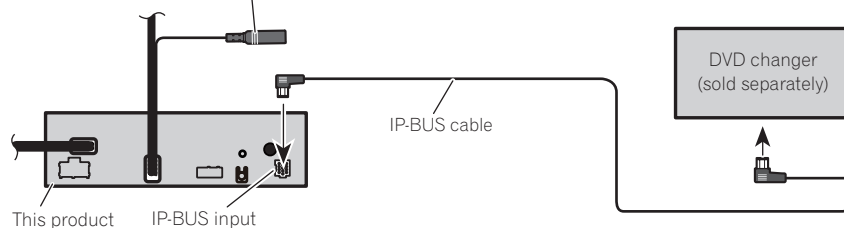

When connecting the external video component and the display

When using a display connected to rear video output

This product's rear video output and rear audio output are for connection of a display to enable passengers in the rear seats to watch the DVD, etc.

⚠ WARNING

- Never install the display in a location where it is visible to the driver while driving.

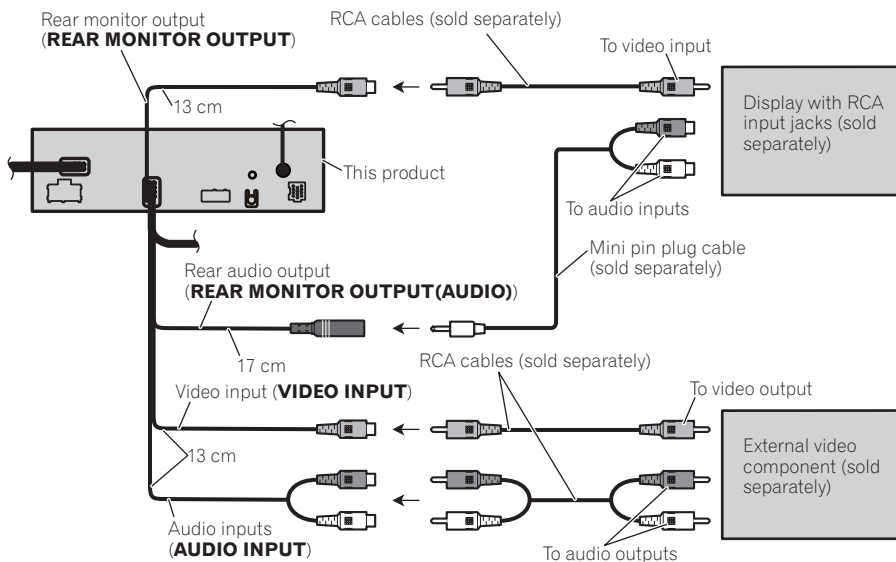

- It is necessary to change **AV Input** in **System Menu** when connecting the external video component.

Installation

When connecting with a multi-channel processor

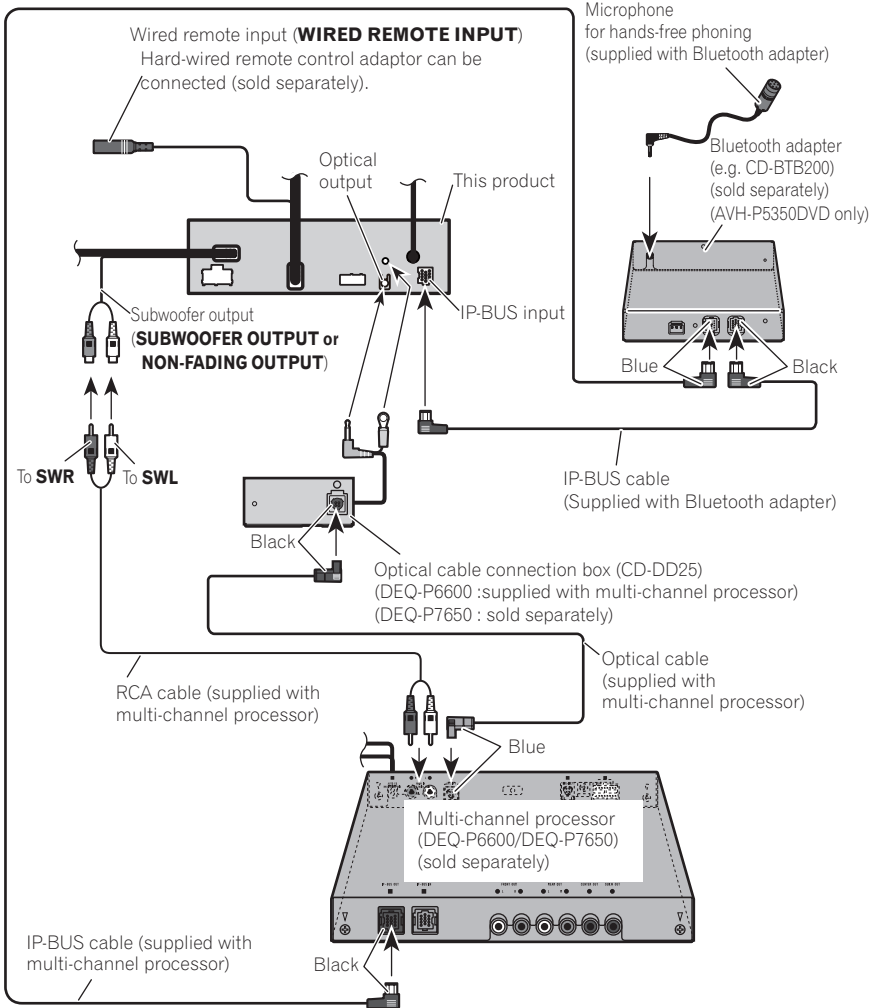

When connecting with a rear view camera

When this product is used with a rear view camera, it is possible to automatically switch from the video to rear view image when the gear shift is moved to REVERSE (R).

! WARNING
USE INPUT ONLY FOR REVERSE OR MIRROR IMAGE REAR VIEW CAMERA. OTHER USE MAY RESULT IN INJURY OR DAMAGE.

! CAUTION

- The screen image may appear reversed.
- The rear view camera function is to be used as an aid to keep an eye on trailers, or while backing up. Do not use for entertainment purposes.
- Objects in the rear view may appear closer or more distant than they actually are.

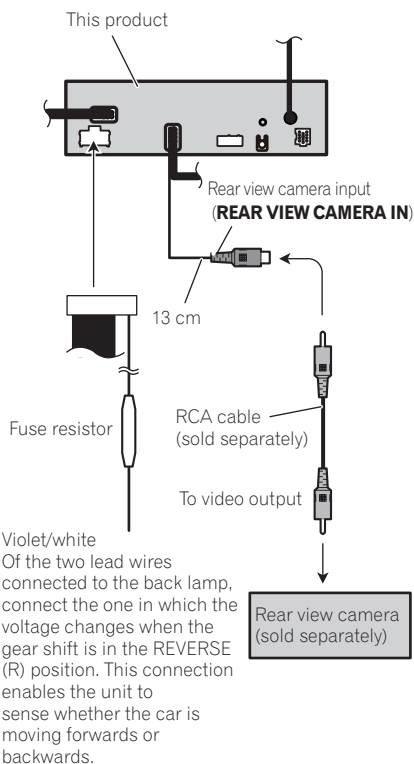

! CAUTION

You must use a camera which outputs mirror reversed images.

It is necessary to set **Camera Polarity** properly in **System Menu** when connecting the rear view camera.

Installation

Connecting and installing the optical cable connection box

⚠ WARNING

- Avoid installing the optical cable connection box in locations where the operation of safety devices such as airbags is prevented by this unit. Otherwise, there is a danger of a fatal accident.
- Avoid installing the optical cable connection box in locations where the operation of the brake may be prevented. Otherwise, it may result in a traffic accident.
- Fix the optical cable connection box securely with the hook and loop fastener or lock tie. If the unit is loose, it disturbs driving stability, which may result in a traffic accident.

⚠ CAUTION

- Install this unit using only the parts supplied with this unit. If other parts are used, this unit may be damaged or could dismount itself, which leads to an accident or other problems.
- Do not install this unit near the doors where rainwater is likely to be spilled on the unit. In-cursion of water into the unit may cause smoke or fire.

Connecting the optical cable

1 Connect the optical cable and ground lead to the main unit.

Connect the optical cable so that it does not protrude from the main unit, as shown in the illustration. Fasten the ground lead to the protrusion on the back of the main unit.

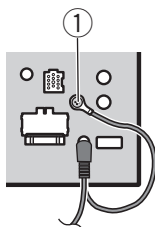

① Screw

2 Connect the optical cable to the optical cable connection box.

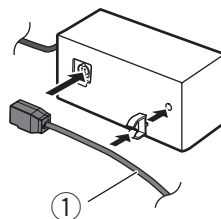

① Optical cable

Installing the optical cable connection box

- **When installing the optical cable connection box with the hook and loop fastener.**

Install the optical cable connection box using the hook and loop fastener in the ample space of the console box.

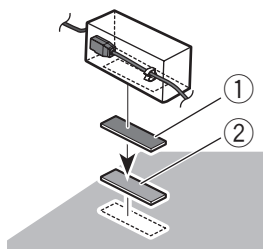

① Hook fastener
② Loop fastener

- **When installing the optical cable connection box with the lock tie.**

Wrap the optical cable and connection box with the protection tape and fasten with the power code using the lock tie.

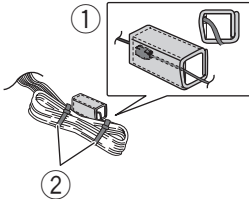

- ① Wrap with the protection tape
- ② Fasten with the lock tie

Installation

Installation

Notes

- Check all connections and systems before final installation.
- Do not use unauthorized parts as this may cause malfunctions.
- Consult your dealer if installation requires drilling of holes or other modifications to the vehicle.
- Do not install this unit where:
 - it may interfere with operation of the vehicle.
 - it may cause injury to a passenger as a result of a sudden stop.
- Do not install the display where it may (i) obstruct the driver's vision, (ii) impair the performance of any of the vehicle's operating systems or safety features, including air bags, hazard lamp buttons or (iii) impair the driver's ability to safely operate the vehicle.
- The semiconductor laser will be damaged if it overheats. Install this unit away from hot places such as near the heater outlet.
- Optimum performance is obtained when the unit is installed at an angle of less than 30°.



- To ensure proper heat dispersal when using this unit, make sure you leave ample space behind the rear panel and wrap any loose cables so they are not blocking the vents when installing the unit.
- The cords must not cover up the area shown in the figure below. This is necessary to allow the amplifiers to radiate freely.

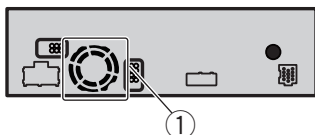

- ① Do not cover this area.

- Make sure you leave enough gap between the dashboard and the LCD panel of this unit so the LCD panel can be opened and closed without contacting with the dashboard.

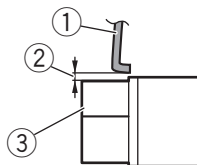

- ① Dashboard
② Leave gap
③ LCD panel

DIN front/rear-mount

This unit can be properly installed using either front-mount or rear-mount installation. Use commercially available parts when installing.

DIN Front-mount

1 Decide the position of the side brackets.

When installing in a shallow space, change the position of side brackets (small).

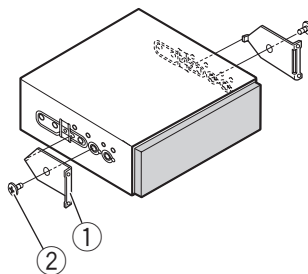

- ① Side bracket (small)
② Flush surface screw (5 mm × 6 mm)

2 Install the unit into the dashboard.

Insert the mounting sleeve into the dashboard. And then secure the mounting sleeve by using a screwdriver to bend the metal tabs (90°) into place.

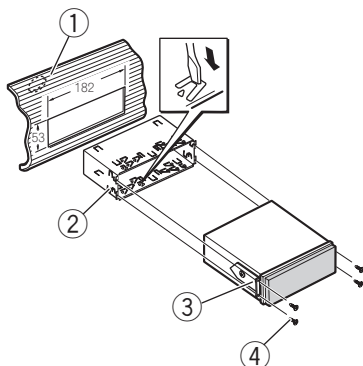

- ① Dashboard
- ② Mounting sleeve
- ③ Side bracket
- ④ Screw (2 mm × 3 mm)

DIN Rear-mount

1 Determine the appropriate position where the holes on the bracket and the side of the unit match.

When installing in a shallow space, use the following screw holes.

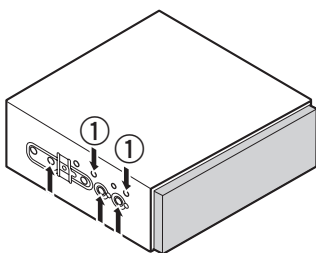

- ① Use binding screws (4 mm × 3 mm) only.

2 Tighten two screws on each side.

Use any of binding screws (4 mm × 3 mm), binding screws (5 mm × 6 mm) or flush surface screws (5 mm × 6 mm), depending on the shape of screw holes in the bracket.

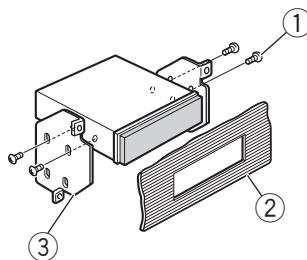

- ① Screw
- ② Dashboard or console
- ③ Factory radio mounting bracket

Removing the unit

Extend top and bottom of the trim ring outwards to remove the trim ring. And then loosen the screws (2 mm × 3 mm) to remove the mounting sleeve.

- When reattaching the trim ring, push the trim ring onto the unit until it clicks. (If the trim ring is attached upside down, the trim ring will not fit properly.)

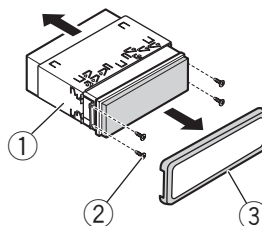

- ① Mounting sleeve
- ② Screw (2 mm × 3 mm)
- ③ Trim ring

Installation

Installing the microphone (AVH-P6350BT only)

⚠ CAUTION

It is extremely dangerous to allow the microphone lead to become wound around the steering column or gearstick. Be sure to install the unit in such a way that it will not obstruct driving.

Note

Install the microphone in a position and orientation that will enable it to pick up the voice of the person operating the system.

When installing the microphone on the sun visor

1 Install the microphone on the microphone clip.

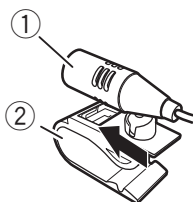

- ① Microphone
- ② Microphone clip

2 Install the microphone clip on the sun visor.

With the sun visor up, install the microphone clip. (Lowering the sun visor reduces the voice recognition rate.)

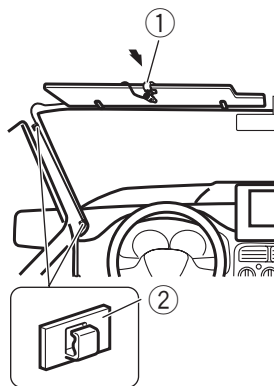

- ① Microphone clip
 - ② Clamp
- Use separately sold clamps to secure the lead where necessary inside the vehicle.

When installing the microphone on the steering column

1 Install the microphone on the microphone clip.

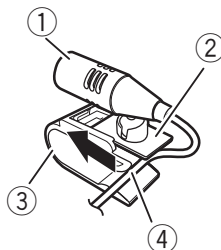

- ① Microphone
 - ② Microphone base
 - ③ Microphone clip
 - ④ Fit the microphone lead into the groove.
- Microphone can be installed without using microphone clip. In this case, detach the microphone base from the microphone clip. To detach the microphone base from the microphone clip, slide the microphone base.

2 Install the microphone clip on the rear side of the steering column.



① Double-sided tape

② Clamp

Use separately sold clamps to secure the lead where necessary inside the vehicle.

Adjusting the microphone angle

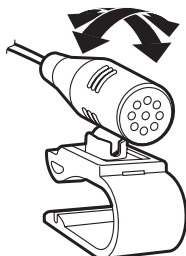

The microphone angle can be adjusted.

Additional Information

Troubleshooting

Common

Symptom	Cause	Action (Reference page)
The power will not turn on. The unit will not operate.	Leads and connectors are incorrectly connected.	Confirm once more that all connections are correct.
	The fuse is blown.	Rectify the cause and then replace the fuse. Be sure to install a fuse with the same rating.
	Noise and/or other factors are causing the built-in microprocessor to operate incorrectly.	Press RESET . (Page 9)
Operation with the remote control is not possible. The unit does not operate correctly even when the appropriate remote control buttons are pressed.	Battery power is low.	Load a new battery.
	Some operations are prohibited with certain discs.	Try operating with another disc.
Playback is not possible.	The disc is dirty.	Clean the disc.
	The type of disc loaded cannot be played on this unit.	Check the disc type.
	The disc loaded is not compatible with this video system.	Change the disc to one that is compatible with your video system.
There is no sound. The volume level will not rise.	Cables are not connected correctly.	Connect the cables correctly.
	The unit is performing still, slow motion or frame-by-frame playback.	There is no sound during still, slow motion or frame-by-frame playback.

Symptom	Cause	Action (Reference page)
There is no image displayed.	The parking brake cable is not connected.	Connect the parking brake cable, and apply the parking brake.
	The parking brake is not applied.	Connect the parking brake cable, and apply the parking brake.
The  icon is displayed, and operation is not possible.	The operation is prohibited for the disc.	This operation is not possible.
	The operation is not compatible with the configuration of the disc.	This operation is not possible.
The image displayed stops (pauses) and the unit cannot be operated.	The data could no longer be read during playback.	Stop playback once, and start playback again.
There is no sound. The volume level is low.	The volume level is low.	Adjust the volume level.
	The attenuator is on.	Turn the attenuator off.
The sound and video skip.	The unit is not firmly secured.	Firmly secure the unit.
	File size and transmission rate are above recommended rates.	Create a DivX file that is within the recommended size and transmission rate.
The aspect ratio is incorrect and the image is stretched.	The aspect ratio setting is incorrect for the display.	Select the appropriate setting for your display. (Page 58)
The motor sounds when the ignition switch is turned ON (or is turned to ACC).	The unit is confirming whether or not a disc is loaded.	This is a normal operation.

Additional Information

Symptom	Cause	Action (Reference page)
Nothing is displayed. The touch panel keys cannot be used.	The rear view camera is not connected. Camera Polarity is at incorrect setting.	Connect a rear view camera. Press and hold MENU to return to the source display and then select the correct setting for Camera Polarity . (Page 64)
No xxxx appears when a display is changed (No Title , for example).	There is no embedded text information.	Switch the display or play another track/file.
Sub-folders cannot be played back.	Folder repeat play has been selected.	Select the repeat range again.
The repeat range changes automatically.	Another folder was selected during repeat play. Track search or fast forward/reverse was performed during file repeat play.	Select the repeat range again. Select the repeat range again.

DVD

Symptom	Cause	Action (Reference page)
Playback is not possible.	The loaded disc has a different region number from this unit.	Replace the disc with one featuring the same region number as this unit.
A parental lock message is displayed and playback is not possible.	Parental lock is activated.	Turn parental lock off or change the level. (Page 58)
Parental lock cannot be canceled.	The code number is incorrect. You have forgotten your code number.	Enter the correct code number. (Page 58) Press RESET . (Page 59)

Symptom	Cause	Action (Reference page)
Dialog language (and subtitle language) cannot be switched.	The DVD being played does not feature multiple language recordings. You can only switch between items indicated in the disc menu.	The language cannot be switched if they are not recorded on the disc. Switch the language using the disc menu.
No subtitles are displayed.	The DVD being played does not feature subtitles. You can only switch between items indicated in the disc menu.	Subtitles are not displayed if they are not recorded on the disc. Switch the language using the disc menu.
Playback is not performed with the audio language and subtitle language settings selected in Video Setup menu.	The DVD being played does not feature dialog or subtitles in the selected language.	The language cannot be switched if the selected language is not recorded on the disc.
The viewing angle cannot be switched.	The DVD being played does not feature scenes shot from multiple angles. You are trying to switch to multi-angle viewing for a scene that was not recorded from multiple angles.	The viewing angle cannot be switched if the DVD does not feature scenes recorded from multiple angles. Switch between multiple angles when watching scenes recorded from multiple angles.

Additional Information

Symptom	Cause	Action (Reference page)
The image is extremely unclear/distorted and dark during playback.	Some discs feature a signal to prohibit copying.	Since this unit is compatible with the analog copy generation management system, when playing a disc that has a signal prohibiting copying, horizontal stripes or other imperfections may appear when viewed on some displays. This is not a malfunction.

Video CD

Symptom	Cause	Action
The PBC (playback control) menu cannot be called up.	The Video CD being played does not feature PBC.	This operation is not available for Video CDs that do not feature PBC.
Repeat play and track/time search are not possible.	The Video CD being played features PBC.	This operation is not available for Video CDs that feature PBC.

iPod

Symptom	Cause	Action
The iPod does not operate correctly.	The cables are incorrectly connected.	Disconnect the cable from the iPod. Once the iPod's main menu is displayed, reconnect the iPod and reset it.
	The iPod version is old.	Update the iPod version.

Bluetooth audio/telephone

Symptom	Cause	Action
The sound from the Bluetooth audio source is not played back.	There is a call in progress on a Bluetooth connected cellular phone.	The sound will be played back when the call is terminated.
	A Bluetooth-connected cellular phone is currently being operated.	Do not operate the cellular phone at this time.
	A call was made with a Bluetooth-connected cellular phone and then immediately terminated. As a result, communication between this unit and the cellular phone was not terminated properly.	Reconnect the Bluetooth connection between this unit and the cellular phone.

Multi-channel processor

Symptom	Cause	Action (Reference page)
There is no sound. The volume level will not rise.	The optical cables are not connected correctly.	Connect the cables correctly.
Audio output is 2-channel audio even though multi-channel audio is selected.	The digital output setting is set to Linear PCM .	Normally, set the digital output setting to Stream . (Page 60)



Error messages

When you contact your dealer or your nearest Pioneer Service Center, be sure to note the error message.

Additional Information

Tuner

Message	Cause	Action
No Data	This unit cannot receive program service name information.	Move to the desirable location with good reception.

DVD

Message	Cause	Action
Different Region Disc	The disc does not have the same region number as this unit.	Replace the DVD with one bearing the correct region number.

Error-02-XX/ FF-FF	The disc is dirty.	Clean the disc.
	The disc is scratched.	Replace the disc.
	The disc is loaded upside down.	Check that the disc is loaded correctly.
	There is an electrical or mechanical error.	Press RESET .

Unplayable Disc	This type of disc cannot be played on this unit.	Replace the disc with one that can be played on this unit.
	The inserted disc does not contain any playable files.	Replace the disc.

Protect	All the files on the inserted disc are embedded with DRM.	Replace the disc.
----------------	---	-------------------

Skipped	The inserted disc contains DRM protected files.	Play an audio file not embedded with Windows Media DRM 9/10.
----------------	---	--

TEMP	The temperature of the unit is outside the normal operating range.	Wait until the unit returns to a temperature within the normal operating limits.
-------------	--	--

Rental Expired.	The inserted disc contains expired DivX VOD content.	Select a file that can be played.
------------------------	--	-----------------------------------

Message	Cause	Action
Video resolution not supported	The inserted disc contains a high definition DivX file.	Select a file that can be played.

It is not possible to write it in the flash.	Flash memory error.	Replace the flash memory.
---	---------------------	---------------------------

Your device is not authorized to play this DivX protected video.	This unit's DivX registration code has not been authorized by the DivX VOD contents provider.	Register this unit to the DivX VOD contents provider.
---	---	---

Unplayable File	This type of file cannot be played on this unit.	Select a file that can be played.
------------------------	--	-----------------------------------

Format Read	Sometimes there is a delay between the start of playback and when you start to hear any sound.	Wait until the message disappears and you hear sound.
--------------------	--	---

Video frame rate not supported.	DivX file's frame rate is more than 30 fps.	Select a file that can be played.
--	---	-----------------------------------

Audio Format not supported.	This type of file is not supported on this unit.	Select a file that can be played.
------------------------------------	--	-----------------------------------

External storage device (USB, SD)

Message	Cause	Action
Unplayable File	This type of file cannot be played on this unit.	Select a file that can be played.
	There are no songs.	Transfer the audio files to the external storage device and connect.

	Security for the connected USB memory is enabled.	Follow the USB memory instructions to disable security.
--	---	---

Format Read	Sometimes there is a delay between the start of playback and when you start to hear any sound.	Wait until the message disappears and you hear sound.
--------------------	--	---

Additional Information

Message	Cause	Action
Skipped	The connected external storage device contains WMA files that are protected by Windows Media™ DRM 9/10.	Play an audio file not embedded with Windows Media DRM 9/10.
Protect	All the files on the connected external storage device is protected by Windows Media DRM 9/10.	Transfer audio files not protected by Windows Media DRM 9/10 to the external storage device and connect.
Incompatible USB	The USB device connected to is not supported by this unit.	Connect a USB portable audio player or USB memory that is USB Mass Storage Class compliant.
	The USB device is not formatted with FAT16 or FAT32.	The connected USB device should be formatted with FAT16 or FAT32.
Incompatible SD	Unsupported SD card is inserted.	Use the supported SD card.
	Non-compatible SD storage device	Remove your device and replace it with a compatible SD storage device.
Check USB	The USB connector or USB cable has short-circuited.	Check that the USB connector or USB cable is not caught in something or damaged.
	The connected USB portable audio player/USB memory consumes more than maximum allowable current.	Disconnect the USB portable audio player/USB memory and do not use it. Turn the ignition switch to OFF, then to ACC or ON and then connect a compliant USB portable audio player/USB memory.

Message	Cause	Action
Error-02-9X/-DX	Communication failed.	Perform one of the following operations. –Turn the ignition switch OFF and back ON. –Disconnect the USB portable audio player/USB memory. –Change to a different source. Then, return to the USB portable audio player/USB memory.
Rental Expired.	The inserted external storage device contains expired DivX VOD content.	Select a file that can be played.
Video resolution not supported	The inserted external storage device contains a high definition DivX file.	Select a file that can be played.
It is not possible to write it in the flash.	Flash memory error.	Replace the flash memory.
Your device is not authorized to play this DivX protected video.	This unit's DivX registration code has not been authorized by the DivX VOD contents provider.	Register this unit to the DivX VOD contents provider.
Format Read	Sometimes there is a delay between the start of playback and when you start to hear any sound.	Wait until the message disappears and you hear sound.
Video frame rate not supported.	DivX file's frame rate is more than 30 fps.	Select a file that can be played.
Audio Format not supported.	This type of file is not supported on this unit.	Select a file that can be played.

Additional Information

iPod

Message	Cause	Action
Format Read	Sometimes there is a delay between the start of playback and when you start to hear any sound.	Wait until the message disappears and you hear sound.
Error-02-6X/-9X/-DX	Communication failed.	Disconnect the cable from the iPod. Once the iPod's main menu is displayed, reconnect the iPod and reset it.
	iPod failure.	Disconnect the cable from the iPod. Once the iPod's main menu is displayed, reconnect the iPod and reset it.
Error-02-67	The iPod firmware version is old.	Update the iPod version.
Stop	There are no songs.	Transfer songs to the iPod.
	There are no songs in the current list.	Select a list that contains songs.
Not Found	No related songs.	Transfer songs to the iPod.

Bluetooth

Message	Cause	Action
Error-10	The power failed for the Bluetooth module of this unit.	Turn the ignition switch OFF and then to ACC or ON. If the error message is still displayed after performing the above action, please contact your dealer or an authorized Pioneer Service Station.

Understanding auto EQ/ auto TA and EQ error messages

When correct measurement of the car's interior acoustic characteristics is not possible using auto TA and EQ, an error message may appear on the display. In such cases, refer to the table below to see what the problem is and how it may be corrected. After checking, try again.

Message	Cause	Action
Error. Please check MIC.	The microphone is not connected.	Plug the optional microphone securely into the jack.
Error. Please check xxxx speaker./ Error. Please check Sub-woofer.	The microphone cannot pick up the measuring tone of a speaker.	<ul style="list-style-type: none"> • Confirm that the speakers are connected correctly. • Correct the input level setting of the power amp connected to the speakers. • Plug the microphone securely into the jack.
Error. Please check noise.	The surrounding noise level is too high.	<ul style="list-style-type: none"> • Stop your car in a place that is quiet, and switch off the engine, air conditioner and heater. • Set the microphone correctly.
Error. Please check battery.	Power is not being supplied from the battery to this unit.	<ul style="list-style-type: none"> • Connect the battery correctly. • Check the battery voltage.



Additional Information

Understanding messages

Messages

Translation

Screen image may appear reversed.

Pioneer recommends the use of a camera which outputs mirror-reversed images. Otherwise, the screen image will appear reversed.



Indicator list

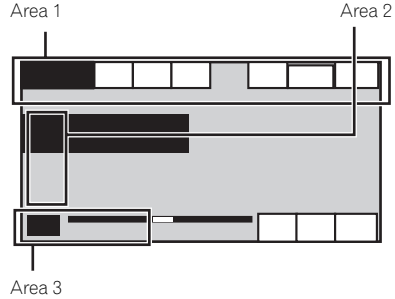

Area 1



Indicates that the selected frequency is being broadcast in stereo.



Indicates that a Bluetooth telephone is connected.

Dolby D

Indicates that the digital format is Dolby Digital.

MPEG-A

Indicates that the digital format is MPEG Audio.

LPCM

Indicates that the digital format is Linear PCM.

48k16

Indicates the sampling frequency.

DTS

Indicates that the digital format is DTS.

1 ch

1+1ch

2 ch

Mch

Indicates the audio channel.

PBCOn

Indicates that a disc with PBC On is being played.

Additional Information



- Indicates that a cellular phone is connected.
- Indicates that an incoming call has been received and has not been checked yet.
- Not displayed for calls made when your cellular phone is disconnected from this unit.



- Indicates the battery strength of the cellular phone.
- The level shown on the indicator may differ from the actual battery strength.
- If the battery strength is not available, nothing is displayed in the battery strength indicator area.



Indicates the signal strength of the cellular phone.

Dolby PLII

Indicates that Dolby Pro Logic II is on.

AutoEQ

Indicates that Auto EQ is on.



Shows which audio language has been selected.



Shows which subtitle language has been selected.



Shows which viewing angle has been selected.



Shows which audio output has been selected.

Area 2



Shows the disc/album currently being played.



Shows the track/song currently being played.



Shows the comment currently being played.



Shows the artist name for the track/song currently being played.



Shows cellular phone information.



Shows general phone information.



Shows home phone information.



Shows office phone information.



Shows other phone information.



Shows the name of the folder currently being played.



Shows the name of the file currently being played.



Shows the preset number of the station currently being tuned in to.



Shows the channel currently being tuned in to.

Area 3



Shows the title number currently being played.



Shows the chapter number currently being played.



Shows the genre of the track/song currently being played.

DEMO

Indicates that the feature demo is on.



Additional Information

Handling guidelines

Discs and player

Use only discs featuring any of following logos.



Use 12-cm discs. Do not use 8-cm discs or an adapter for 8-cm discs.

Use only conventional, fully circular discs. Do not use shaped discs.



Do not insert anything other than a DVD (-R/-RW) or CD (-R/-RW) into the disc loading slot.

Do not use cracked, chipped, warped, or otherwise damaged discs as they may damage the player.

Unfinalized CD-R/CD-RW discs cannot be played back.

Do not touch the recorded surface of the discs.

Store discs in their cases when not in use.

Do not attach labels, write on or apply chemicals to the surface of the discs.

To clean a disc, wipe the disc with a soft cloth outward from the center.

Condensation may temporarily impair the player's performance. Let it rest for about one hour to adjust to a warmer temperature. Also, wipe any damp discs off with a soft cloth.

Playback of discs may not be possible because of disc characteristics, disc format, recorded application, playback environment, storage conditions, and so on.

Road shocks may interrupt disc playback.

Read the precautions for discs before using them.

Certain functions may not be available for some DVD video discs.

It may not be possible to play back some DVD video discs.

It is not possible to play back DVD-RAM discs.

This unit is not compatible with discs recorded in AVCHD (Advanced Video Codec High Definition) format. Do not insert AVCHD discs as you may not be able to eject the disc.

External storage device (USB, SD)

Depending on the external storage device (USB, SD), the following problems may occur.

- Operations may vary.
- The storage device may not be recognized.
- Files may not be played back properly.

USB storage device

Connections via USB hub are not supported.

Do not connect anything other than a USB storage device.

Firmly secure the USB storage device when driving. Do not let the USB storage device fall onto the floor, where it may become jammed under the brake or accelerator pedal.

Depending on the USB storage device, the device may cause noise to occur in the radio.

Copyright protected files that are stored in the USB devices cannot be played back.

You cannot connect a USB portable audio player/USB memory to this unit via USB hub.

Partitioned USB memory is not compatible with this unit.

Depending on the kind of USB portable audio player/USB memory you use, the device may not be recognized or audio files may not be played back properly.

Do not leave the USB portable audio player/USB memory in direct sunlight for extended amounts of time. Doing so may cause the device to malfunction from the extreme rise in temperature.

Additional Information

SD memory card

This unit supports only the following types of SD memory cards.

- SD
- SDHC

Keep the SD memory card out of the reach of children. Should the SD memory card be swallowed, consult a doctor immediately.

Do not touch the connectors of the SD memory card directly with your fingers or with any metal device.

Do not insert anything other than an SD memory card into the SD card slot. If a metal object (such as a coin) is inserted into the slot, the internal circuits may break and cause malfunctions.

Do not insert a damaged SD memory card (e.g. warped, label peeled off) as it may not be ejected from the slot.

Do not try to force an SD memory card into the SD card slot as the card or this unit may be damaged.

When ejecting an SD memory card, press it and hold it until it clicks. It is dangerous for you to release your finger immediately after you press on the card as the card may shoot out of the slot and hit you in the face, etc. If the card shoots out of the slot, it may become lost.

iPod

To ensure proper operation, connect the dock connector cable from the iPod directly to this unit.

Firmly secure the iPod when driving. Do not let the iPod fall onto the floor, where it may become jammed under the brake or accelerator pedal.

About iPod settings

- When an iPod is connected, this unit changes the EQ (equalizer) setting of the iPod to off in order to optimize the acoustics. When you disconnect the iPod, the EQ returns to the original setting.
- You cannot set Repeat to off on the iPod when using this unit. Repeat is automatically changed to All when the iPod is connected to this unit.

Incompatible text saved on the iPod will not be displayed by the unit.

DVD-R/DVD-RW discs

Unfinalized DVD-R/DVD-RW discs which have been recorded in the Video format (video mode) cannot be played back.

Playback of DVD-R/DVD-RW discs may not be possible, due to disc characteristics, scratches or dirt on the disc, or dirt, condensation, etc. on the lens of this unit.

Depending on the application settings and the environment, playback of discs recorded on a personal computer may not be possible. (For details, contact the manufacturer of the application.)

CD-R/CD-RW discs

When CD-R/CD-RW discs are used, playback is possible only for discs which have been finalized.

Playback of CD-R/CD-RW discs recorded on a music CD recorder or a personal computer may not be possible due to disc characteristics, scratches or dirt on the disc, or dirt, condensation, etc., on the lens of this unit.

Depending on the application settings and the environment, playback of discs recorded on a personal computer may not be possible. (For details, contact the manufacturer of the application.)

Playback of CD-R/CD-RW discs may become impossible in case of direct exposure to sunlight, high temperatures, or the storage conditions in the vehicle.

Titles and other text information recorded on a CD-R/CD-RW disc may not be displayed by this unit (in the case of audio data (CD-DA)).

DualDiscs

DualDiscs are two-sided discs that have a recordable CD for audio on one side and a recordable DVD for video on the other.

Playback of the DVD side is possible with this unit. However, since the CD side of DualDiscs is not physically compatible with the general CD standard, it may not be possible to play the CD side with this unit. Frequent loading and ejecting of a DualDisc may result in scratches on the disc. Serious scratches can lead to playback problems on this unit. In some cases, a DualDisc may become stuck in the disc loading slot and will not eject. To prevent this, we recommend you refrain from using DualDisc with this unit. Please refer to the information from the disc manufacturer for more detailed information about DualDiscs.

Additional Information

JPEG picture files

JPEG is short for Joint Photographic Experts Group and refers to a still image compression technology standard.

Files are compatible with Baseline JPEG and EXIF 2.1 still images up to a resolution of 8 192 × 7 680. (EXIF format is used most commonly with digital still cameras.)

Playback of EXIF format files that were processed by a personal computer may not be possible.

There is no progressive JPEG compatibility.

DivX video files

Depending on the composition of the file information, such as the number of audio streams or file size, there may be a slight delay when playing back discs.

Some special operations may be prohibited due to the composition of the DivX files.

Only DivX files downloaded from a DivX partner site are guaranteed for proper operation. Unauthorized DivX files may not operate properly.

DRM rental files cannot be operated until playback is started.

Recommended file size: 2 Mbps or less with a transmission rate of 2 GB or less.

The ID code of this unit must be registered to a DivX VOD provider in order to playback DivX VOD files. For information on ID codes, refer to *Displaying the DivX® VOD registration code* on page 60.

For more details about DivX, visit the following site: <http://www.divx.com/>

Important

- When naming a JPEG image file, add the corresponding filename extension (.jpg, .jpeg, .jpe or .jfif).
- This unit plays back files with these filename extensions (.jpg, .jpeg, .jpe or .jfif) as a JPEG image file. To prevent malfunctions, do not use these extensions for files other than JPEG image files. 

Compressed audio compatibility (disc, USB, SD)

WMA

File extension: .wma

Bit rate: 5 kbps to 320 kbps (CBR), VBR

Sampling frequency: 8 kHz to 48 kHz

Windows Media Audio Professional, Lossless, Voice/DRM Stream/Stream with video: Not compatible

MP3

File extension: .mp3

Bit rate: 8 kbps to 320 kbps

Sampling frequency: 8 kHz to 48 kHz (32 kHz, 44.1 kHz, 48 kHz for emphasis)

Compatible ID3 tag version: 1.0, 1.1, 2.2, 2.3 (ID3 tag Version 2.x is given priority over Version 1.x.)

M3u playlist: Not compatible

MP3i (MP3 interactive), mp3 PRO: Not compatible

AAC

Compatible format: AAC encoded by iTunes

File extension: .m4a

Sampling frequency: 8 kHz to 44.1 kHz

Bit rate: 8 kbps to 320 kbps

Apple Lossless: Not compatible

AAC file bought from the iTunes Store (.m4p file extension): Not compatible

DivX compatibility

Compatible format: DivX video format implemented in relation to DivX standards

File extensions: .avi or .divx

DivX Ultra format: Not compatible

DivX HD format: Not compatible

DivX files without video data: Not compatible

DivX plus HD: Not compatible

Compatible audio codec: MP2, MP3, Dolby Digital

Additional Information

LPCM: Not compatible

Bit rate: 8 kbps to 320 kbps (CBR), VBR

Sampling frequency: 8 kHz to 48 kHz

Compatible external subtitle file extension: .srt

Supplemental information

Some characters in a file name (including the file extension) or a folder name may not be displayed.

This unit may not operate correctly depending on the application used to encode WMA files.

There may be a slight delay at the start of playback of audio files embedded with image data or audio files stored on an external storage device (USB/SD) that has numerous folder hierarchies.

Disc

Playable folders: up to 700

Playable files: up to 999 for CD-R/CD-RW

Playable files: up to 3500 for DVD-R/DVD-RW

File system: ISO 9660 Level 1 and 2, Romeo, Joliet, UDF 1.02 (DVD-R/DVD-RW)

Multi-session playback: Compatible

Packet write data transfer: Not compatible

Regardless of the length of blank sections between the songs from the original recording, compressed audio discs play with a short pause between songs.

External storage device (USB, SD)

Playable folders: up to 6 000

Playable files: up to 65 535, up to 255 for one folder

Playback of copyright-protected files: Not compatible

Partitioned external storage device (USB, SD): Only the first playable partition can be played.

There is no compatibility for Multi Media Cards (MMC).

Compatibility with all SD memory cards is not guaranteed.

This unit is not compatible with SD-Audio/SD-Video.



CAUTION

- Pioneer accepts no responsibility for data lost on the USB memory/USB portable audio player/SD memory card even if that data is lost while using this unit.
- Do not leave the discs/external storage device (USB, SD) or iPod in places with high temperatures. 

iPod compatibility

This unit supports only the following iPod models. Supported iPod software versions are shown below. Older versions may not be supported.

- iPhone 4 (software version 4.1)
- iPhone 3GS (software version 4.1)
- iPhone 3G (software version 4.1)
- iPhone (software version 3.1.3)
- iPod nano 6th generation (software version 1.0)
- iPod nano 5th generation (software version 1.0.2)
- iPod nano 4th generation (software version 1.0.4)
- iPod nano 3rd generation (software version 1.1.3)
- iPod nano 2nd generation (software version 1.1.3)
- iPod nano 1st generation (software version 1.3.1)
- iPod touch 4th generation (software version 4.1)
- iPod touch 3rd generation (software version 4.0)
- iPod touch 2nd generation (software version 4.0)
- iPod touch 1st generation (software version 3.1.3)
- iPod classic 160GB (software version 2.0.4)
- iPod classic 120GB (software version 2.0.1)
- iPod classic (software version 1.1.2)
- iPod 5th generation (software version 1.3)

Depending on the generation or version of the iPod, some functions may not be available.

Operations may vary depending on the software version of iPod.

When using an iPod, an iPod Dock Connector to USB Cable is required.

When you use Pioneer CD-IU50V/CD-IU200V interface cable, consult your dealer for details.

About the file/format compatibility, refer to the iPod manuals.

Audio Book, Podcast: Compatible

Additional Information

! CAUTION

Pioneer accepts no responsibility for data lost on the iPod, even if that data is lost while this unit is used.

Sequence of audio files

The user cannot assign folder numbers and specify playback sequences with this unit.

Example of a hierarchy

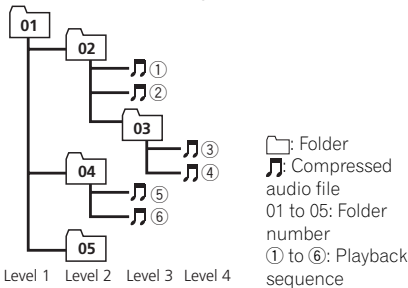

Disc

Folder selection sequence or other operation may differ depending on the encoding or writing software.

External storage device (USB, SD)

The playback sequence is the same as the recorded sequence in the external storage device (USB, SD).

To specify the playback sequence, the following method is recommended.

- ① Create a file name that includes numbers that specify the playback sequence (e.g., 001xxx.mp3 and 099yyy.mp3).
- ② Put those files into a folder.
- ③ Save the folder that contains the files to the external storage device (USB, SD).

However, depending on the system environment, you may not be able to specify the playback sequence.

For USB portable audio players, the sequence is different and depends on the player.

Using the display correctly

! CAUTION

- If liquid or foreign matter should get inside this unit, turn off the power immediately and consult your dealer or the nearest authorized PIONEER Service Station. Do not use the unit in this condition because doing so may result in fire, electric shock, or other failure.
- If you notice smoke, a strange noise or smell, or any other abnormal signs from the display, turn off the power immediately and consult your dealer or the nearest authorized PIONEER Service Station. Using this unit in this condition may result in permanent damage to the system.
- Do not disassemble or modify this unit, as there are high-voltage components inside which may cause electric shock. Be sure to consult your dealer or the nearest authorized PIONEER Service Station for internal inspection, adjustments, or repairs.

Handling the display

- Never touch the screen with anything besides your finger when operating the touch panel function. The screen can scratch easily.
- When the display is subjected to direct sunlight for a long period of time, it will become very hot resulting in possible damage to the LCD screen. You should avoid exposing the display unit to direct sunlight as much as possible.
- The display should be used within the temperature range of -10°C to $+60^{\circ}\text{C}$. At temperatures higher or lower than this operating temperature range, the display may not operate normally.
- The LCD screen is exposed in order to increase its visibility within the vehicle. Do not press it strongly on it as this may damage it.
- Do not push the LCD screen forcefully as this may scratch it.

Additional Information

Liquid crystal display (LCD) screen

- Heat from the heater may damage the LCD screen, and cool air from the cooler may cause moisture to form inside the display resulting in possible damage.
- Small black dots or white dots (bright dots) may appear on the LCD screen. These are due to the characteristics of the LCD screen and do not indicate a malfunction.
- When using a cellular phone, keep the antenna away from the display to prevent disruption of the video image by the appearance of spots, colored stripes, etc.

LED (light-emitting diode) backlight

- At low temperatures, using the LED backlight may increase image lag and degrade the image quality due to the characteristics of the LCD screen. Image quality will improve with an increase in temperature.
- To protect the LED backlight, the display will darken in the following environments:
 - In the direct sunlight
 - Near the heater vent
- The product lifetime of the LED backlight is more than 10 000 hours. However, it may decrease if used in high temperatures.
- If the LED backlight reaches the end of its product lifetime, the screen will become dark and the image will no longer be projected. In such cases, please consult your dealer or the nearest authorized PIONEER Service Station.

Keeping the display in good condition

- When removing dust from the screen or cleaning the display, first turn the system power off, then wipe with a soft dry cloth.
- When wiping the screen, take care not to scratch the surface. Do not use harsh or abrasive chemical cleaners. ▣

Copyright and trademark

This item incorporates copy protection technology that is protected by U.S. patents and other intellectual property rights of Rovi Corporation. Reverse engineering and disassembly are prohibited.

Bluetooth

The Bluetooth® word mark and logos are registered trademarks owned by Bluetooth SIG, Inc. and any use of such marks by Pioneer Corporation is under license. Other trademarks and trade names are those of their respective owners.

- Bluetooth is a short-range wireless radio connectivity technology that is developed as a cable replacement for mobile phones, handheld PCs and other devices. Bluetooth operates in 2.4 GHz frequency range and transmits voice and data at speeds up to 1 megabit per second. Bluetooth was launched by a special interest group (SIG) that comprises of Ericsson Inc., Intel Corp., Nokia Corp., Toshiba and IBM in 1998, and it is currently developed by nearly 2 000 companies worldwide.

DVD video

 is a trademark of DVD Format/Logo Licensing Corporation.

iTunes

Apple and iTunes are trademarks of Apple Inc., registered in the U.S. and other countries.

Additional Information

MP3

Supply of this product only conveys a license for private, non-commercial use and does not convey a license nor imply any right to use this product in any commercial (i.e. revenue-generating) real time broadcasting (terrestrial, satellite, cable and/or any other media), broadcasting/streaming via internet, intranets and/or other networks or in other electronic content distribution systems, such as pay-audio or audio-on-demand applications. An independent license for such use is required. For details, please visit <http://www.mp3licensing.com>.

WMA

Windows Media is either a registered trademark or trademark of Microsoft Corporation in the United States and/or other countries. This product includes technology owned by Microsoft Corporation and cannot be used or distributed without a license from Microsoft Licensing, Inc.

SD memory card

SD Logo is a trademark of SD-3C, LLC.
SDHC Logo is a trademark of SD-3C, LLC.

iPod & iPhone

iPhone, iPod, iPod classic, iPod nano, and iPod touch are trademarks of Apple Inc., registered in the U.S. and other countries.

“Made for iPod” and “Made for iPhone” mean that an electronic accessory has been designed to connect specifically to iPod or iPhone, respectively, and has been certified by the developer to meet Apple performance standards.

Apple is not responsible for the operation of this device or its compliance with safety and regulatory standards.

Please note that the use of this accessory with iPod or iPhone may affect wireless performance.

Dolby Pro Logic II

Manufactured under license from Dolby Laboratories. “Dolby”, “Pro Logic”, and the

double-D symbol are trademarks of Dolby Laboratories.

DTS Digital Out

Manufactured under license under U.S. Patent #: 5,451,942 & other U.S. and worldwide patents issued & pending. DTS and the Symbol are registered trademarks and DTS Digital Out and the DTS logos are trademarks of DTS, Inc. Product includes software. © DTS, Inc. All Rights Reserved.

DivX

DivX®, DivX Certified® and associated logos are trademarks of DivX, Inc. and are used under license.

ABOUT DIVX VIDEO: DivX® is a digital video format created by DivX, Inc. This is an official DivX Certified® device that plays DivX video. Visit divx.com for more information and software tools to convert your files into DivX video.

ABOUT DIVX VIDEO-ON-DEMAND: This DivX Certified® device must be registered in order to play purchased DivX Video-on-Demand (VOD) movies. To obtain your registration code, locate the DivX VOD section in *Menu operations*. Go to vod.divx.com for more information on how to complete your registration. ■

Additional Information

Language code chart for DVD

Language (code), input code

Japanese (ja), 1001	Dzongkha (dz), 0426	Kurdish (ku), 1121	Kinyarwanda (rw), 1823
English (en), 0514	Ewe (ee), 0505	Komi (kv), 1122	Sanskrit (sa), 1901
French (fr), 0618	Esperanto (eo), 0515	Cornish (kw), 1123	Sardinian (sc), 1903
Spanish (es), 0519	Estonian (et), 0520	Kirghiz, Kyrgyz (ky), 1125	Sindhi (sd), 1904
German (de), 0405	Basque (eu), 0521	Latin (la), 1201	Northern Sami (se), 1905
Italian (it), 0920	Persian (fa), 0601	Luxembourghish (lb), 1202	Sangho (sg), 1907
Chinese (zh), 2608	Fulah (ff), 0606	Ganda (lg), 1207	Sinhala (si), 1909
Dutch, Flemish (nl), 1412	Finnish (fi), 0609	Limburgan (li), 1209	Slovak (sk), 1911
Portuguese (pt), 1620	Fijian (fj), 0610	Lingala (ln), 1214	Slovenian (sl), 1912
Swedish (sv), 1922	Faroese (fo), 0615	Lao (lo), 1215	Samoan (sm), 1913
Russian (ru), 1821	Western Frisian (fy), 0625	Lithuanian (lt), 1220	Shona (sn), 1914
Korean (ko), 1115	Irish (ga), 0701	Luba-Katanga (lu), 1221	Somali (so), 1915
Greek (el), 0512	Gaelic (gd), 0704	Latvian (lv), 1222	Albanian (sq), 1917
Afar (aa), 0101	Galician (gl), 0712	Malagasy (mg), 1307	Serbian (sr), 1918
Abkhazian (ab), 0102	Guarani (gn), 0714	Marshallese (mh), 1308	Swati (ss), 1919
Avestan (ae), 0105	Gujarati (gu), 0721	Maori (mi), 1309	Sotho, Southern (st), 1920
Afrikaans (af), 0106	Manx (gv), 0722	Macedonian (mk), 1311	Sundanese (su), 1921
Akan (ak), 0111	Hausa (ha), 0801	Malayalam (ml), 1312	Swahili (sw), 1923
Amharic (am), 0113	Hebrew (he), 0805	Mongolian (mn), 1314	Tamil (ta), 2001
Aragonese (an), 0114	Hindi (hi), 0809	Marathi (mr), 1318	Telugu (te), 2005
Arabic (ar), 0118	Hiri Motu (ho), 0815	Malay (ms), 1319	Tajik (tg), 2007
Assamese (as), 0119	Croatian (hr), 0818	Maltese (mt), 1320	Thai (th), 2008
Avaric (av), 0122	Haitian (ht), 0820	Burmese (my), 1325	Tigrinya (ti), 2009
Aymara (ay), 0125	Hungarian (hu), 0821	Nauru (na), 1401	Turkmen (tk), 2011
Azerbaijani (az), 0126	Armenian (hy), 0825	Bokmal (nb), 1402	Tagalog (tl), 2012
Bashkir (ba), 0201	Herero (hz), 0826	Ndebele, North (nd), 1404	Tswana (tn), 2014
Belarusian (be), 0205	Interlingua (ia), 0901	Nepali (ne), 1405	Tonga (to), 2015
Bulgarian (bg), 0207	Indonesian (id), 0904	Ndonga (ng), 1407	Turkish (tr), 2018
Bihari (bh), 0208	Interlingue (ie), 0905	Nynorsk (nn), 1414	Tsonga (ts), 2019
Bislama (bi), 0209	Igbo (ig), 0907	Norwegian (no), 1415	Tatar (tt), 2020
Bambara (bm), 0213	Sichuan Yi (ii), 0909	Ndebele, South (nr), 1418	Twi (tw), 2023
Bengali (bn), 0214	Inupiaq (ik), 0911	Navajo, Navaho (nv), 1422	Tahitian (ty), 2025
Tibetan (bo), 0215	Ido (io), 0915	Chichewa (ny), 1425	Uighur, Uygur (ug), 2107
Breton (br), 0218	Icelandic (is), 0919	Occitan (oc), 1503	Ukrainian (uk), 2111
Bosnian (bs), 0219	Inuktitut (iu), 0921	Ojibwa (oj), 1510	Urdu (ur), 2118
Catalan (ca), 0301	Javanese (jv), 1022	Oromo (om), 1513	Uzbek (uz), 2126
Chechen (ce), 0305	Georgian (ka), 1101	Oriya (or), 1518	Venda (ve), 2205
Chamorro (ch), 0308	Kongo (kg), 1107	Ossetian (os), 1519	Vietnamese (vi), 2209
Corsican (co), 0315	Kikuyu, Gikuyu (ki), 1109	Panjabi, Punjabi (pa), 1601	Volapük (vo), 2215
Cree (cr), 0318	Kuanyama (kj), 1110	Pali (pi), 1609	Walloon (wa), 2301
Czech (cs), 0319	Kazakh (kk), 1111	Polish (pl), 1612	Wolof (wo), 2315
Church Slavonic (cu), 0321	Kalaallisut (kl), 1112	Pashto, Pushto (ps), 1619	Xhosa (xh), 2408
Chuvash (cv), 0322	Central Khmer (km), 1113	Quechua (qu), 1721	Yiddish (yi), 2509
Welsh (cy), 0325	Kannada (kn), 1114	Romansh (rm), 1813	Yoruba (yo), 2515
Danish (da), 0401	Kanuri (kr), 1118	Rundi (rn), 1814	Zhuang, Chuang (za), 2601
Divehi (dv), 0422	Kashmiri (ks), 1119	Romanian (ro), 1815	Zulu (zu), 2621



Additional Information

Specifications

General

Rated power source	14.4 V DC (allowable voltage range: 12.0 V to 14.4 V DC)
Grounding system	Negative type
Maximum current consumption	10.0 A
Dimensions (W × H × D): D	
Chassis	178 mm × 50 mm × 165 mm
Nose	170 mm × 46 mm × 27 mm
Weight	2.2 kg

Display

Screen size/aspect ratio	7.0 inch wide/16:9 (effective display area: 154.0 mm × 86.9 mm)
Pixels	345 600 (1 440 × 240)
Display method	TFT active matrix, driving type
Color system	NTSC/PAL/PAL-M/SECAM compatible
Durable temperature range (power off)	-20 °C to +80 °C

Audio

Maximum power output	50 W × 4 70 W × 1/2 Ω (for subwoofer)
Continuous power output	22 W × 4 (1 kHz, 5% THD, 4 Ω load, both channels driven)
Load impedance	4 Ω (4 Ω to 8 Ω (2 Ω for 1 ch) allowable)
Preout maximum output level	4.0 V
Equalizer (8-Band Graphic Equalizer):	
Frequency	40 Hz/80 Hz/200 Hz/400 Hz/ 1 kHz/2.5 kHz/8 kHz/10 kHz
Gain	± 12 dB
HPF:	
Frequency	50 Hz/63 Hz/80 Hz/100 Hz/ 125 Hz
Slope	-12 dB/oct
Subwoofer (mono):	
Frequency	50 Hz/63 Hz/80 Hz/100 Hz/ 125 Hz
Slope	-18 dB/oct
Gain	+6 dB to -24 dB
Phase	Normal/Reverse

Bass boost:	
Gain	+12 dB to 0 dB

DVD Player

System	DVD video, Video CD, CD, WMA, MP3, AAC, DivX, JPEG system
Usable discs	DVD video, Video CD, CD, CD-R/RW, DVD-R/RW/R DL
Region number	4 for South American and Oceanian models
Region number	2 for Middle East Asian and South African models
Frequency response	5 Hz to 44 000 Hz (with DVD, at sampling frequency 96 kHz)
Signal-to-noise ratio	96 dB (1 kHz) (IEC-A net- work) (RCA level)
Output level:	
Video	1.0 V _{p-p} /75 Ω (±0.2 V)
Number of channels	2 (stereo)
MP3 decoding format	MPEG-1 & 2 Audio Layer 3
WMA decoding format	Ver. 7, 7.1, 8, 9, 10, 11, 12 (2 ch audio) (Windows Media Player)
AAC decoding format	MPEG-4 AAC (iTunes en- coded only) (.m4a) (Ver. 9.0.3 and earlier)
DivX decoding format	Home Theater Ver. 3, 4, 5, 2, 6 (.avi, .divx)

USB

USB standard specification	USB 1.1, USB 2.0 full speed
Maximum current supply	500 mA
USB Class	MSC (Mass Storage Class)
File system	FAT16, FAT32
MP3 decoding format	MPEG-1 & 2 Audio Layer 3
WMA decoding format	Ver. 7, 7.1, 8, 9, 10, 11, 12 (2 ch audio) (Windows Media Player)
AAC decoding format	MPEG-4 AAC (iTunes en- coded only) (Ver. 9.0.3 and earlier)
DivX decoding format	Home Theater Ver. 3, 4, 5, 2, 6 (.avi, .divx)

SD

Compatible physical format	Version 1.10
File system	FAT12, FAT16, FAT32
MP3 decoding format	MPEG-1 & 2 Audio Layer 3

Additional Information

WMA decoding format	Ver. 7, 7.1, 8, 9, 10, 11, 12 (2 ch audio) (Windows Media Player)
AAC decoding format	MPEG-4 AAC (iTunes encoded only) (Ver. 9.0.3 and earlier)
DivX decoding format	Home Theater Ver. 3, 4, 5.2, 6 (.avi, .divx)

FM tuner

Frequency range	87.5 MHz to 108.0 MHz
Usable sensitivity	9 dBf (0.8 μ V/75 Ω mono, S/N: 30 dB)
Signal-to-noise ratio	72 dB (IEC-A network)

AM tuner

Frequency range	531 kHz to 1 602 kHz (9 kHz) 530 kHz to 1 640 kHz (10 kHz)
Usable sensitivity	25 μ V (S/N: 20 dB)
Signal-to-noise ratio	62 dB (IEC-A network)

Bluetooth

(AVH-P6350BT)	
Version	Bluetooth 2.0 certified
Output power	+4 dBm Maximum (Power class 2)

Infrared remote control

Wavelength	945 nm
Output	typ; 10 mw/sr per Infrared LED

Note

Specifications and the design are subject to modifications without notice. 



Visit us on the World Wide Web at

<http://pioneer.jp/group/index-e.html>

<Middle East & Africa>

Pioneer Gulf.FZE

<http://www.pioneer-uae.com>

<Oceania>

Pioneer Electronics Australia. Pty.Ltd

<http://www.pioneeraus.com.au>

<Asia>

Pioneer Electronics Asiacentre.Pte

<http://www.pioneer.com.sg>

Pioneer (HK) Ltd.

<http://www.pioneerhongkong.com.hk>

Pioneer High Fidelity Taiwan Co., Ltd.

<http://www.pioneer-twn.com.tw>

<Latin>

Pioneer International Latin America S.A.

<http://www.pioneer-latin.com>

PIONEER CORPORATION

1-1, Shin-ogura, Saiwai-ku, Kawasaki-shi,
Kanagawa 212-0031, JAPAN

PIONEER ELECTRONICS (USA) INC.

P.O. Box 1540, Long Beach, California 90801-1540, U.S.A.
TEL: (800) 421-1404

PIONEER EUROPE NV

Haven 1087, Keetberglaan 1, B-9120 Melsele, Belgium/Belgique
TEL: (0) 3/570.05.11

PIONEER ELECTRONICS ASIACENTRE PTE. LTD.

253 Alexandra Road, #04-01, Singapore 159936
TEL: 65-6472-7555

PIONEER ELECTRONICS AUSTRALIA PTY. LTD.

5 Arco Lane, Heatherton, Victoria, 3202 Australia
TEL: (03) 9586-6300

PIONEER ELECTRONICS OF CANADA, INC.

300 Allstate Parkway, Markham, Ontario L3R 0P2, Canada
TEL: 1-877-283-5901
TEL: 905-479-4411

PIONEER ELECTRONICS DE MEXICO, S.A. de C.V.

Bldv.Manuel Avila Camacho 138 10 piso
Col.Lomas de Chapultepec, Mexico, D.F. 11000
TEL: 55-9178-4270

先鋒股份有限公司

台北市內湖區瑞光路407號8樓
電話：(02) 2657-3588

先鋒電子(香港)有限公司

香港九龍尖沙咀海港城世界商業中心
9樓901-6室
電話：(0852) 2848-6488

Published by Pioneer Corporation.
Copyright © 2010 by Pioneer Corporation.
All rights reserved.

Printed in Thailand

<CRB3576-A/N> RD,RI

<KNAZX> <10K00000>