

# HDMI Switcher

ITEM NO.: HS04, HS07

HS04, HS07 HDMI switch allows multi different digital (video & audio) sources to share one video display. Built in Auto Scan and Auto Jump function for variety application. They are perfect for home theater systems no more hassles of manually plugging in different HDMI connectors to view different video sources. (ex: DVD player, setup top box, DVR...)

## HS04 4 Input 1 Output HDMI Switcher

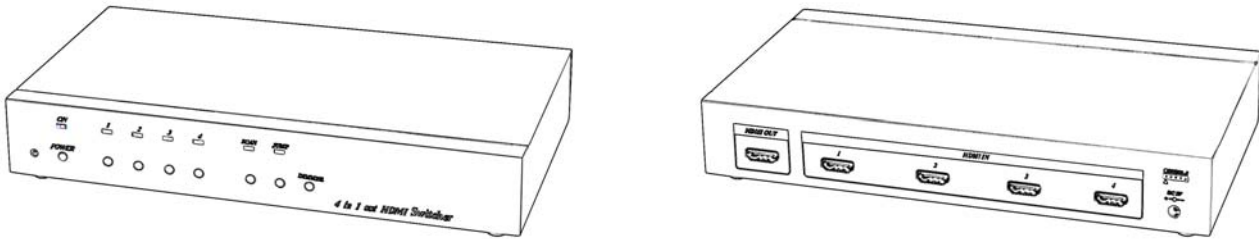

- Switch easily between any four HDMI sources by remote control or push button front.
- HDMI 1.3a compliance, support Deep Color 12 Bits/Color (Data rate up to 2.25Gbps) and 3D capable.
- Extends the range of HDMI compliant device by equalizing and reclocking the HDMI signal.
- Supports high resolution input:  
HDTV: 480i, 576i, 480p, 576p, 720p, 1080i and 1080p @60Hz.
- HDCP pass-through.
- LED brightness could be adjusted for different environment.
- Built in auto scan switching input function, to automatically select the next one with the signal of the input.
- Built in auto jump function, to automatically select the new video input.
- Easy to use front panel control of switching or using the included remote control.
- **PC Remote control option: USB, RS-232 or RS-485 terminal devices. (Order separately).**
- The switcher box is the ideal for all of devices, offering both high-definition video and audio switching capability.

## HS07 7 Input 1 Output HDMI Switcher

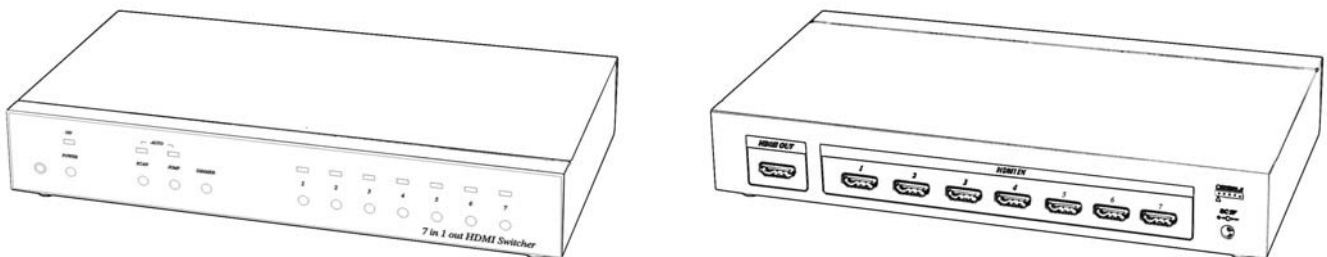

- Identical to HS04, but switch 7 HDMI devices.

## Panel View:

### HS04

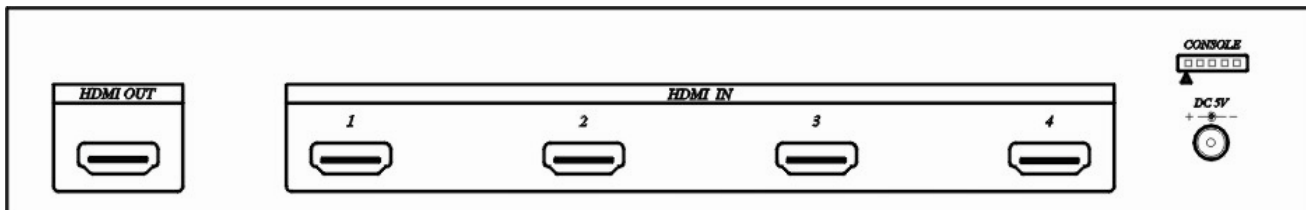
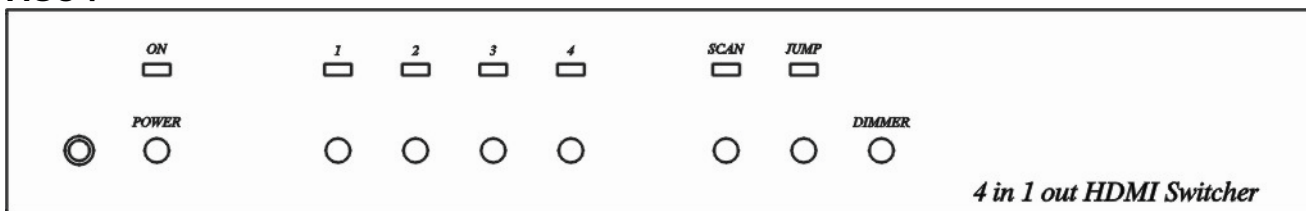

### HS07

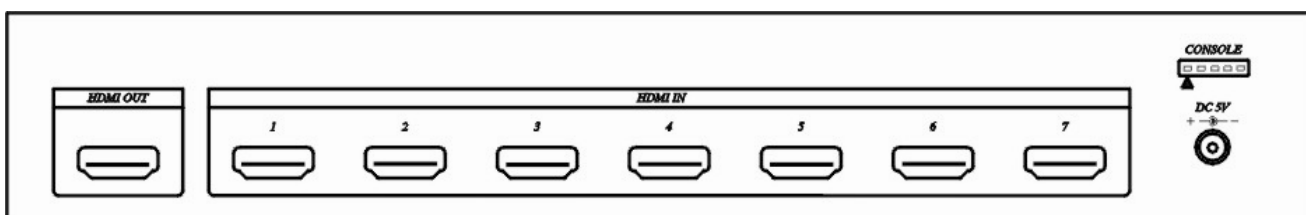
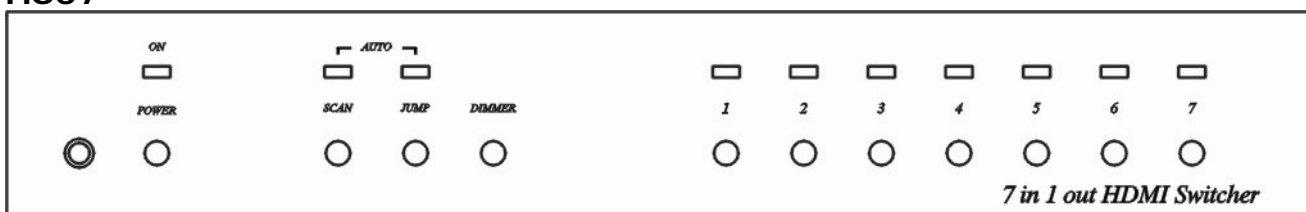

## Installation View:

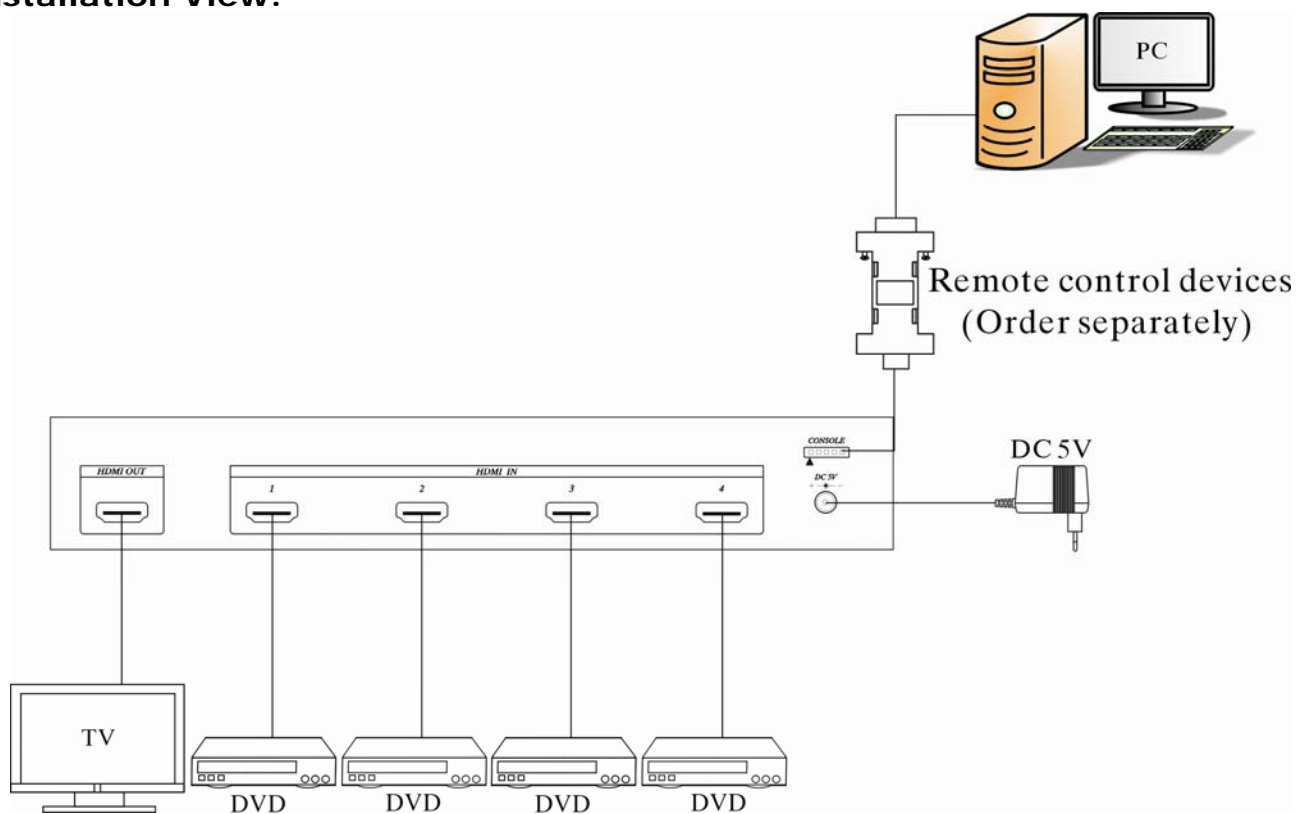

## Specification:

ITEM	HS04	HS07
Connector	HDMI Type A	
Input / Output	HDMI (Input) x 4 · HDMI (Output) x 1	HDMI (Input) x 7 · HDMI (Output) x 1
Color depth	12 Bits/Color (Data rate up to 2.25Gbps)	
Resolutions	1080p (Max)	
Function Button	Button x 8	Button x 11
Power Supply	5V DC · 1000mA Regulated ( External )	
Power Consumption	300mA ( Max )	600 mA (Max)
Dimensions	253 x 138.5 x 40 (mm)	
Shipping Weight	800 g	805 g

RoHS   

### LED Indication:

Power	ON/OFF	System activate/ standby.
	FLASH	Panel button or IR remote control disabled by remote PC.
AUTO SCAN	ON/OFF	Auto scan function activated/disabled.
AUTO JUMP	ON/OFF	Auto jump function activated/disabled.
1, 2, 3, 4	ON	Currently selected input signal channel.
	FLASH	No signal input.

### Panel Button Function:

Power: System activate/ standby.  
 AUTO SCAN: Auto scan function activated/disabled.  
 AUTO JUMP: Auto jump function activated/disabled.  
 DIMMER: LED brightness adjustment.  
 1, 2, 3, 4: Currently select input signal channel and disable auto scan function.

### Remote Control Operating A,B Mode Switching:

There are two remote control operating modes: When this device power on, you could switch A,B mode by pressing the panel "power" button and remote control " \* " button together.

Mode A operating mode: It come with auto scan & auto jump functions.

Mode B operating mode: When auto scan & auto jump functions no need to use, which only need single button for quick operation on AV switch.

Factory default is set to (Mode A).

### IR remote control Mode A Operating:

 Power symbol System activate/standby.

 Select previous available input and activates auto scan function.

▼	Select next available input and activates auto scan function.
◀	Select previous input and disable auto scan function.
▶	Select next input and disable auto scan function.
1、2、3、4	Currently select input and disable auto scan function.
0	Auto jump function activated/disabled.
#	LED brightness adjustment.
5、6、7、8、9	Reserved (no function) .

### **IR remote control Mode B Operating:**

⏻ Power symbol	System activate/standby.
▲	Select previous input and system activate.
▼	Select next input and system activate.
◀	Select previous input and system activate.
▶	Select next input and system activate.
1、2、3、4	Currently select input and system activate.
#	LED brightness adjustment.
5、6、7、8、9、0	Reserved (no function) .

### **Auto Scan Function:**

Under auto scan operation, if the selected input video signal disappears over 0.5 second, it would automatically select the previous or next input with video signal.

### **Auto Jump Function:**

Under auto jump operation, if there is a new video signal input, it will automatically switch to a new video signal input

### **LED brightness setting:**

LED brightness could be set up as the following 4 levels:

- 1 Minimum Brightness
- 2 Normal Brightness
- 3 Maximum Brightness
- 4 Brightness auto change

Factory default is set to level 3.

Under Brightness auto change mode, press any button or IR remote control, or video signal changed (video signal disappears or show up), LED status will show the maximum brightness up to 5 seconds then back to the minimum brightness.

## Computer Remote Control Function:

This console could use optional USB, RS-232 and RS-485 terminal cable to connect with computer, To use terminal program for remote control operation, the communication format is 9600,8,N,1 (9600 Bps, 1 start bits, 8 data bits, 1 stop bit).

Under remote control operation, If it shows 「COMMAND」, then it is “under command mode”. It could easily be operated and set by entering the following commands in the chart.

Press 「Enter」 : if it shows 「OK!」 then the previous command is completed; showing 「ERROR!」 indicates the previous command is incorrect.

## Command Mode Instruction:

[COMMAND]	[DESCRIPTION]
n	Currently select input and disable auto scan.
PRE	Select previous available input and activates auto scan.
NEXT	Select next available input and activates auto scan.
SCAN y	Auto scan function activated/disabled.
JUMP y	Auto jump function activated/disabled.
ACTIVATE	System activate.
STANDBY	System standby.
MODE x	Select operation mode A/B.
IR y	IR remote button lock/unlock.
KEY y	Panel button lock/unlock.
LED n	LED brightness adjustment.
SAVE	Save setting.
LOAD	Load setting.
KEYPAD	Keypad mode operation.
SIGNAL	Display input signal status.
STATUS	Display setting.
VERSION	Display firmware version.
?	Show all commands.

[SYMBOL]	[PARAMETER]
n	1   2   3   4
x	A   B
y	ON   OFF

Space characters between the command and parameters can be ignored ◦

## Virtual Remote Control Mode:

- Showing 「KEYPAD :」 when it is under virtual remote control mode, which you could enter the following commands at the terminal to simulate the IR remote control operation.
- Press 「Enter」 : if it shows 「OK!」 then the previous command is completed; showing 「ERROR!」 indicates the previous command is incorrect.

## System Activate Virtual Remote Control Mode A/B Operate description:

- MODE A :

[COMMAND]	[DESCRIPTION]
1 2 3 4	Currently select input and disable auto scan.
-	Select previous available input and activates auto scan.
+	Select next available input and activates auto scan.
L	Select previous input and disable auto scan.
R	Select next input and disable auto scan.
0	Auto jump function activated/disabled.
/	System activate/standby.
.	LED brightness adjustment.
Q	Command mode operation.
S	Display setting and input signal status.
?	Show all commands.

➤MODE B :

[COMMAND]	[DESCRIPTION]
1 2 3 4	Currently select input.
-	Select previous input.
+	Select next input.
L	Select previous input.
R	Select next input.
/	System activate/standby.
.	LED brightness adjustment.
Q	Command mode operation.
S	Display setting and input signal status.
?	Show all commands.

**System Standby Virtual Remote Control Mode A/B Operate description:**

➤MODE A :

[COMMAND]	[DESCRIPTION]
/	System activate/standby.
Q	Command mode operation.
S	Display setting and input signal status.
?	Show all commands.

➤MODE B :

[COMMAND]	[DESCRIPTION]
1 2 3 4	Currently select input and system activate.
-	Select previous input and system activate.
+	Select next input and system activate.
L	Select previous input and system activate.
R	Select next input and system activate.
/	System activate/standby.
Q	Command mode operation.
S	Display setting and input signal status.
?	Show all commands.

**Remark:**

There are some DVD equipments still have +5V signal output under power off status, it will cause auto jump and auto scan function abnormal, please disable auto jump and auto scan function to avoid any abnormal operation.