User's Manual

TDO3000
Series Oscilloscope

Manual Print History

The manual print history shown below lists all the printing dates and editions. The printing date changes when a new edition is released. The latest editions can be downloaded from our website.

December 2009 First Edition

May 2010..... Second Edition

Warranty

This Tonghui instrument product is warranted against defects in material and workmanship for a period of two years from the date of shipment. Other items such as test fixtures, test cables are warranted for 90 days from the date of shipment. During the warranty period, we will, at our option, either repair or replace products which prove to be defective.

For warranty service or repair, this product must be returned to a service facility designated by Tonghui. Purchaser shall prepay shipping charges to Tonghui and Tonghui shall pay for the return of the product to Buyer. However, Buyer shall pay all shipping charges, duties, taxes, and any other charges for products returned to Tonghui from another country.

Limitation of Warranty

This warranty does not apply to defects resulting from improper or inadequate maintenance and care by Buyer, Buyer-supplied software or interfacing, unauthorized modification or misuse, operation outside of the environmental specifications for the product, or improper site preparation or maintenance.

No other warranty is expressed or implied. Tonghui specially disclaims the implied warranties of merchantability and fitness for a particular use.

Tonghui's responsibility to repair or replace defective products is the sole and exclusive remedy provided to the customer for breach of this warranty. Tonghui shall not be liable for any direct, indirect, special, incidental, or consequential damages, whether based on contract, tort, or any other legal theory.

Safety Precautions

The following safety precautions must be observed to avoid injury and prevent damage to this product or any products connected to it. To avoid potential hazards, read the operating information carefully before using the product and use this product only as specified.

NOTE: This product complies with INSTALLATION CATEGORY I as well as POLLUTION DEGREE 2. This product is an INDOOR USE product.

- Ground the Instrument

Before operating the instrument, make sure the instrument chassis is grounded with the 3-pole power cable.

- Don't operate in an explosive atmosphere

To prevent explosion or fire, don't operate the instrument in the presence of inflammable gases or fumes.

-
- Use the proper fuse

Replace the broken fuse with the same type and rating for continuous protection against fire hazard.

- Keep away from live circuits

Don't remove the instrument covers when operating the instrument. Component replacement and internal adjustment can only be done by qualified personnel. Don't replace components with the power cable connected. Dangerous voltage may remain even after the power cable has been disconnected. Always remove the power cable from the instrument and discharge circuits before touching them.

Contents

Contents

Contents	7
1. Getting Started.....	10
Inspect Package Contents.....	10
Front Panel	11
Rear Panel	19
Naming Regulation	21
Interpreting the Display	22
2. Basic Operation	25
Probe Compensation.....	25
Using Quick Help	27
Using Autoset	28
Vertical Controls.....	30
CH1, CH2 Menu.....	32
MATH Functions	43
REF Function.....	49

Contents

Horizontal Controls	52
Trigger Controls.....	63
ACQUIRE Menu	79
UTILITY Menu	89
MEASURE Menu	110
SAVE/LOAD Menu	125
CURSOR Menu.....	136
DISPLAY Menu	142
RUN Controls.....	145
Short-Cut Controls	146
F/A WG Controls	147
3. Application Examples	171
Make Simple Measurements.....	171
Capture a Single-Shot Signal.....	173
Reduce the Random Noise on a Signal	175
Trigger on a Video Signal	177

Contents

PASS/FAIL Measurement	179
Waveform Recorder	181
Cursor Measurements.....	185
To Output a Sine Waveform.....	191
To Output a Amplitude Modulated Waveform	193
4. System Message and General Problems.....	195
System Message	195
General Problems.....	199
5. Specifications and Characteristics.....	201
Specifications	201
Characteristics.....	202

1. Getting Started

Inspect Package Contents

Inspect the shipping container for damage. If the shipping container or cushioning material is damaged, it should be kept until the contents of the shipment have been checked for completeness and the oscilloscope has been checked mechanically and electrically.

Verify that you received the following items and any optional accessories you may have ordered.

- TDO3000 Series Oscilloscope
- Two oscilloscope probes
- Power cord
- User's Manual
- BNC cable (only available when F/A WG module is installed.)

If the contents are incomplete, if there is mechanical damage or defeat, please contact us.

Getting Started

Front Panel

This section provides an introduction to the front panel of the TDO3000 Series Oscilloscope. Generally, you set up the front panel controls first and then perform a measurement.

The keys or knobs on the front panel bring up softkey menus on the display that provide further access to oscilloscope features. Entry knob  is usually used to select or input values. Five softkeys are located along the right side of the display screen.

The following figures show the front panel of the TDO3000 Series Oscilloscope.

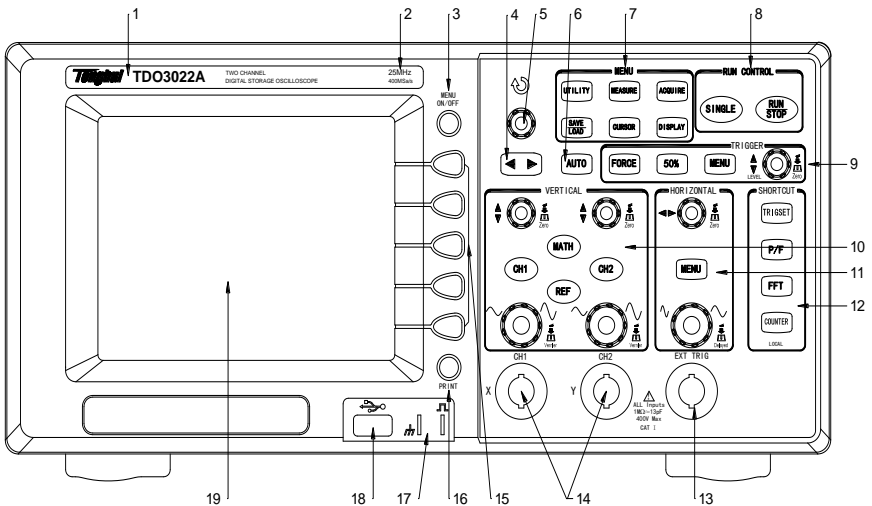

Front Panel of DSO

Getting Started

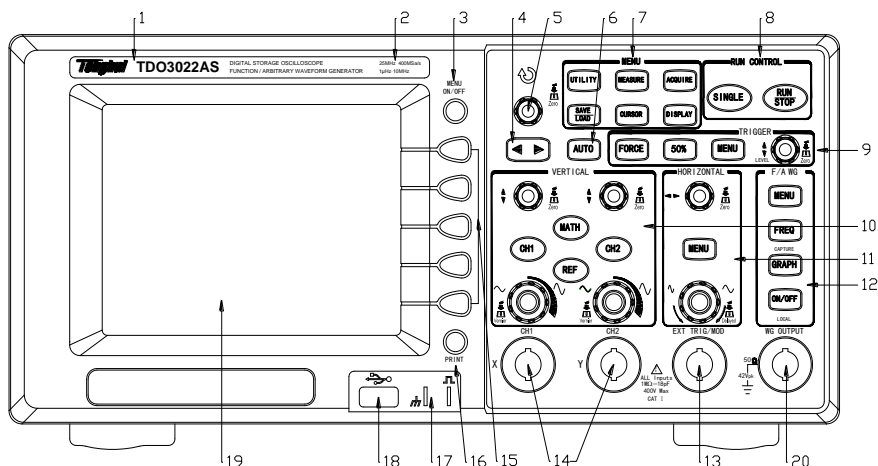

Front Panel of DSO with F/A WG Module

1. Trademark and Model

Indicate the oscilloscope model and trademark of the manufacturer.

2. Bandwidth and Sample Rate

Indicate the bandwidth and sample rate of the current oscilloscope model.

The frequency range of F/A WG will also be included when F/A WG module is installed.

3. **MENU ON/OFF** Key

Press this key to toggle menu display on and off.

4. **◀▶** Key

Press the **◀▶** key to read a previous or next page of the help information.

Getting Started

The  key can also be used to select a position of an input value before you change it with the entry knob when F/A WG module is installed.

5. Entry Knob

The Entry knob is used to select items from menus and input values. Its function changes when different menu is displayed. The curved arrow symbol  above the Entry knob illuminates when the Entry knob is active and can be used to input a value or select a menu item.

When the Entry knob is inactive, the Entry knob can be used to adjust the intensity of the waveforms displayed on the screen.

6. Key

When you press the  key, the oscilloscope will quickly determine which channels are active, and it will turn these active channels on and scale them to display the input signals.

7. MENU Keys

When you press a menu key on the front panel, the oscilloscope will display the corresponding menu on the right side of the screen. The menu shows the options that are available when you press the softkeys directly to the right of the screen. There are totally six menu keys available:

Getting Started

UTILITY menu

Activate the system utility functions, such as System Setup, Language Setup, I/O Setup, and Print Setup etc.

MEASURE menu

Perform automated voltage and time measurements of displayed waveforms.

ACQUIRE menu

The ACQUIRE menu lets you set the oscilloscope to acquire in Normal, Peak Detect, or Average mode, and lets you select Real Time or Equivalent sampling.

SAVE/LOAD menu

You can save your current setup and trace to the oscilloscope's internal memory or to an USB mass storage device, and then retrieve the setup or trace later.

CURSOR menu

Press the **CURSOR** key to activate the cursors that you can use for making custom voltage or time measurement on scope signals.

DISPLAY menu

You can change the appearance of waveforms and the display screen, select the color schemes and adjust the brightness or intensity etc.

Getting Started

8. RUN Control Keys

The **RUN/STOP** key will illuminate in green when the oscilloscope is looking for a trigger. When the trigger mode is set to Normal mode, the display will not update until a trigger is found. If the trigger mode is set to Auto mode, the oscilloscope looks for a trigger, and if no trigger is found, it will be triggered automatically and the waveform of input signals will be showed immediately.

Press the **RUN/STOP** key again to stop acquiring data and the **RUN/STOP** key will illuminate in red. Now you can pan across and zoom in on the acquired waveform.

Press **SINGLE** key to make a single acquisition of data. The key will illuminate in orange until the oscilloscope is triggered.

9. Trigger Controls

These controls are used to control how the oscilloscope triggers to capture waveforms.

10. Vertical Controls

You can use the vertical position control knob to move the waveforms up and down on the display. There is one vertical position control knob for each channel.

You can press the channel key **CH1** or **CH2** to switch the channel on or off, or access the channel's menu in the softkeys. There is one channel on/off key for each channel.

Getting Started

You can press the **MATH** key to access FFT (Fast Fourier Transform), multiply, subtract, and add functions. You can press the **REF** key to save or load a reference waveform from the internal memory or external USB mass storage device.

You can use the vertical scale control knob to change the vertical scale of a waveform. The waveform display will contract or expand relative to the ground reference level. There is one vertical scale control knob for each channel.

11. Horizontal Controls

When the oscilloscope is running, the horizontal position control knob lets you set the acquisition window relative to the trigger point. When the oscilloscope is stopped, you can turn this knob to pan through the data horizontally. This let you see the captured waveform before or after the trigger.

Press the horizontal **MENU** key to access the menu where you can split the oscilloscope display in Main and Delayed section, and where you can select X-Y and Roll modes.

Turn the horizontal sweep speed control knob to adjust the sweep speed. This changes the time base on the display. When adjusted after the waveform has been acquired and the oscilloscope is stopped, this has the

Getting Started

effect of stretching out or squeezing the waveform horizontally.

12. Short-Cut Keys/ F/A WG Keys

These four short-cut keys: **TRIGSET**, **P/F**, **FFT** and **COUNTER** provide another quick direct approach to access the trigger SETUP, Pass/Fail, FFT menus, and hardware frequency counter function.

When the F/A WG module is installed, these four keys are served as **MENU**, **FREQ**, **GRAPH** and **ON/OFF**.

13. External Trigger Input/Modulating Waveform Output

When the F/A WG module is not installed, this is the external trigger input BNC connector.

Only when the F/A WG module is installed and the trigger source is neither EXT nor EXT/5, this BNC connector serves as modulating waveform output, otherwise it remains as external trigger input.

14. Channel Input BNC

This is the channel's input BNC connector. Connect the oscilloscope probe or BNC cable to the BNC Connector.

15. Softkeys

Five softkeys are used to select control and parameter functions. Each softkey has a softkey label along its left side.

16. **PRINT** Key

Press this key to print the current waveform display or screen display to a USB mass storage device.

17. **Probe Compensation Terminals**

Use these two probe compensation terminals to match each probe's characteristics to the oscilloscope channel to which it is connected.

18. **USB Host Connector**

USB host connector can be connected to an USB mass storage device.

19. **LCD Display**

The 320*234 matrix (5.6 inch) color TFT LCD displays captured channel waveforms, setup information, measurement results and softkeys for setting up parameters.

20. **WG Output BNC**

When F/A WG module is installed, this is the F/A WG signal output BNC connector.

When F/A WG module is not installed, this connector is blanked.

Getting Started

Rear Panel

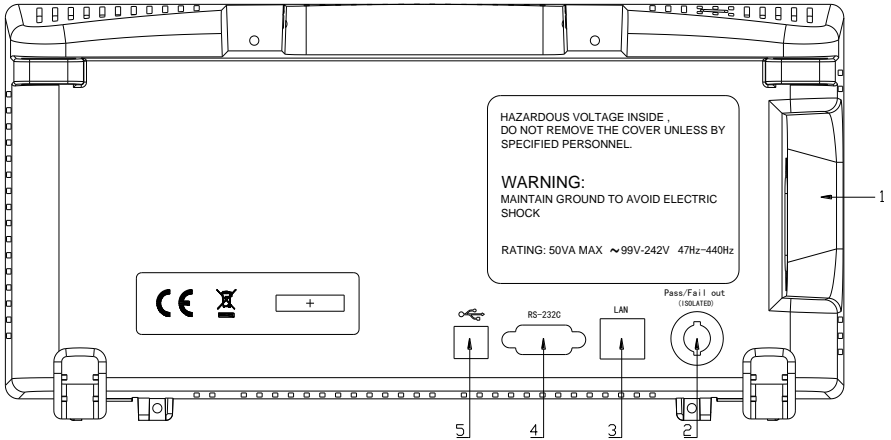

Rear panel

1. Line Input Receptacle

AC power cord receptacle. Attach to an AC power line with safety ground.

2. Pass/Fail Output Connector

Isolated Pass/Fail output connector, a pull-up resistor must be connected to output the Pass/Fail signal.

3. RS232 Interface Connector

RS232 interface connector can be connected to a controller or a computer.

4. USB Device Connector

USB device connector can be connected to a controller or a computer.

Getting Started

5. LAN Connector (B series only)

LAN interface can be used to control the instrument over the network.

Getting Started

Naming Regulation

Take TDO3102AS as an example to describe the naming regulation of the TDO3000 Series Oscilloscope.

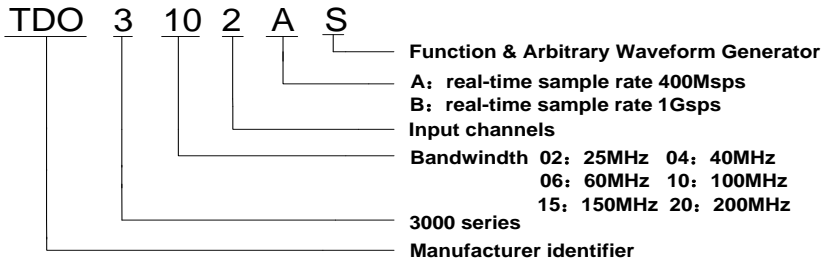

Naming regulation

Getting Started

Interpreting the Display

The oscilloscope display contains channel acquisitions, setup information, measurement results, and softkeys for setting up parameter.

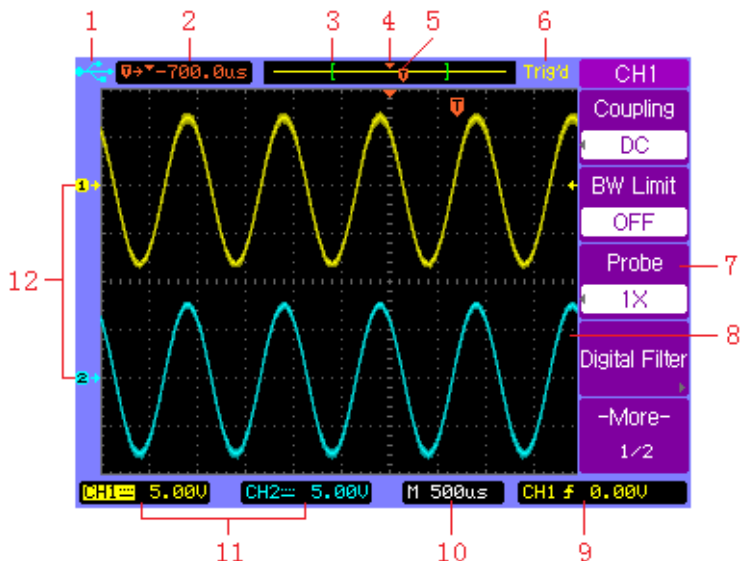

Interpreting the display

1. The USB icon illuminates when a USB disk is inserted and ready to be operated.
2. Readout shows the trigger position relative to the horizontal center of the screen.
3. The square brackets show the location of current display window within the whole record. The record line color consists with the active waveform color.

Getting Started

4. Horizontal center position icon shows the horizontal center location within the record.
5. Trigger position icon shows the trigger location within the record.
6. Acquisition status readout shows AUTO, STOP, WAIT, Trig'd , Trig? or ROLL.
7. Softkey menu which allows you to set up additional parameters from front-panel softkeys.
8. The display area contains the waveform acquisitions, channel identifiers, trigger and ground level indicators. Each channel's information appears in corresponding color.
9. Trigger readout shows trigger information such as trigger source, trigger type as well as trigger level.
10. Horizontal readout shows the Main or Delayed time base.
11. Channel readouts show the scale factor, coupling, bandwidth limit, digital filter, and invert status.
12. Waveform baseline icons show the zero-volt level of the waveforms. The icon colors correspond to the waveform colors.

2. Basic Operation

Probe Compensation

Perform this adjustment to match your probe to the input channel. This should be done whenever you attach a passive probe for the first time to any input channel. A poorly compensated probe can introduce measurement errors.

1. Set both the probe and the oscilloscope attenuation factor to X10 respectively.
2. Connect the oscilloscope probe to channel 1. Attach the probe tip and reference lead to the 3Vp-p@1kHz terminal and to the chassis terminal, then press **AUTO** key.
3. Use a nonmetallic tool to adjust the trimmer capacitor on the probe for the flattest pulse possible. The trimmer capacitor is located on the probe BNC connector.

Perfect compensated

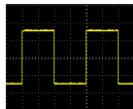

Over compensated

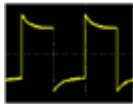

Under compensated

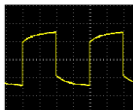

Basic Operation

4. Connect probes to channel 2. Repeat the procedure.
This matches each probe to each channel.

Basic Operation

Using Quick Help

TDO3000 Series Oscilloscope has a Quick Help system that provides help for each front-panel key and softkey.

Press and hold down the key or softkey for which you would like to view help information. The help information will be displayed and remain at the center of the screen as shown below until another key is pressed or a knob is turned.

If there are more help information pages, press the  key to browse the previous or next pages.

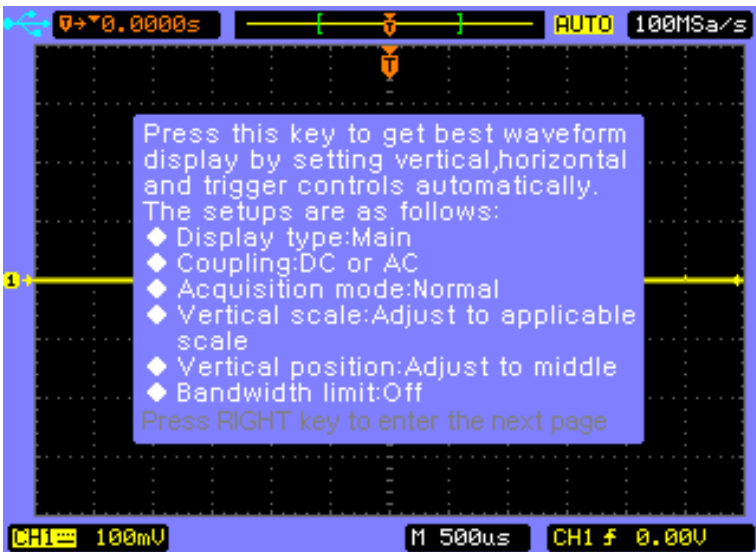

Basic Operation

Using Autoset

TDO3000 Series Digital Storage Oscilloscope provides the Autoset function which sets the vertical, horizontal, and trigger controls properly and automatically.

Autoset function detects, turns on, and scales any channel with a repetitive waveform that has a frequency of at least 50Hz, a duty cycle greater than 0.5%, and an amplitude of at least 10mV peak-to-peak. Any channels that do not meet these requirements are turned off.

When you are using more than one channel, the Autoset function sets the vertical controls for each channel and used the channel 1 to set the horizontal and trigger controls.

To configure the oscilloscope quickly and automatically, press the **AUTO** key to display the connected signals that are active.

To configure the oscilloscope to display multiple cycles, press **Multi-Cycle** softkey in the **AUTO** menu.

To configure the oscilloscope to display a single cycle, press **Single Cycle** softkey in the **AUTO** menu.

To undo the effects of Autoset, press the **Undo Autoset** softkey in the **AUTO** menu before pressing any other key. This is useful when you have unintentionally pressed the

Basic Operation

AUTO key or do not like the settings Autoset has selected and want to return to your previous settings.

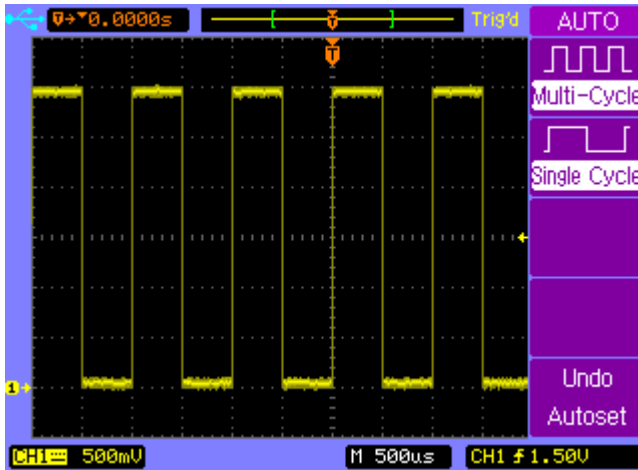

Autoset of oscilloscope channel 1

Vertical Controls

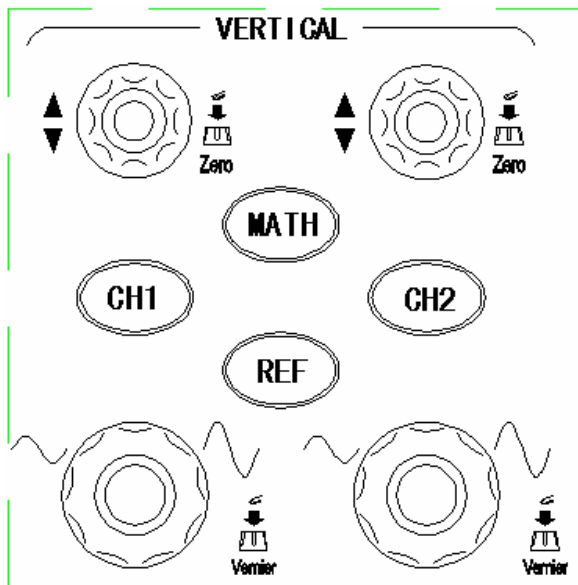

Vertical controls

Vertical Position Control (CH1, CH2)

Turn the small vertical position knob above the channel key to move the channel's waveform and its ground level icon (⚡) up or down on the display. The voltage value momentarily displayed in the bottom left portion of the display represents the voltage difference between the vertical center of the display and the ground level(⚡).

Basic Operation

Press the small vertical position knob above the channel key to bring the channel's waveform and its ground level icon (ⓐ) directly back to the vertical center of the display.

Channel Key **CH1**, **CH2**, **MATH**, **REF**

Press the channel key from the front panel to display the channel's menu and turns the display of the channel on or off. The channel is displayed when the key is illuminated.

You must be viewing the menu of a channel before you can turn it off. For example, if CH1 and CH2 are both displayed and the **CH2** menu is now displayed. In order to turn **CH1** off, you should press the **CH1** key first and **CH1** menu will be displayed, then press **CH1** key again to turn off **CH1**.

Vertical Scale Control (**CH1**, **CH2**)

Turn the large vertical scale knob below the channel key to set the scale factor for the channel. The vertical scale knob changes the channel scale in a 1-2-5 step sequence. The channel scale factor value is displayed in the bottom left portion of the display.

Press the large vertical scale knob to toggle between Fine and Coarse. When fine is selected, you can change the channel's vertical sensitivity in smaller resolution. When coarse is selected, the vertical scale knob changes the channel scale in a 1-2-5 step sequence.

Basic Operation

CH1, CH2 Menu

Press the channel key **CH2** to display the channel's menu and turns the display of the channel on.

Channel Coupling

Press the channel key **CH2**, then press the **Coupling** softkey to select AC coupling mode.

AC coupling places a high pass filter in series with the input signal that blocks the DC component of the input signal. AC coupling is useful for viewing waveforms with large DC offsets.

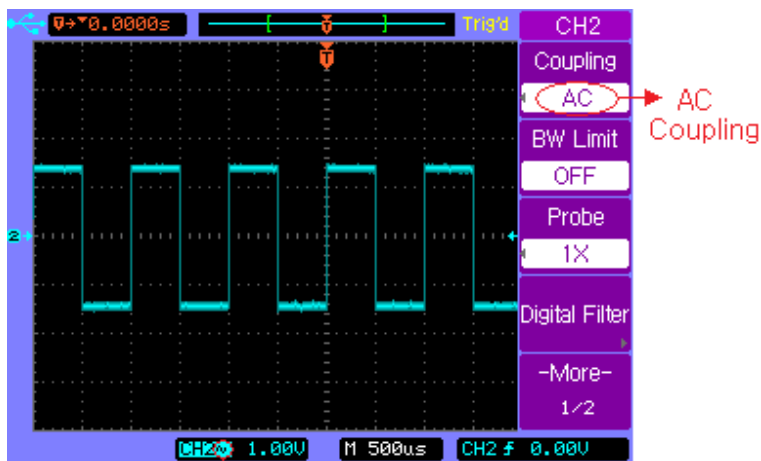

AC Coupling Status

AC Coupling

Basic Operation

Press the channel key **CH2**, then press the **Coupling** softkey to select DC coupling mode.

DC coupling passes both AC and DC components of the input signal. DC coupling is useful for viewing low frequency waveforms that do not have large DC offsets.

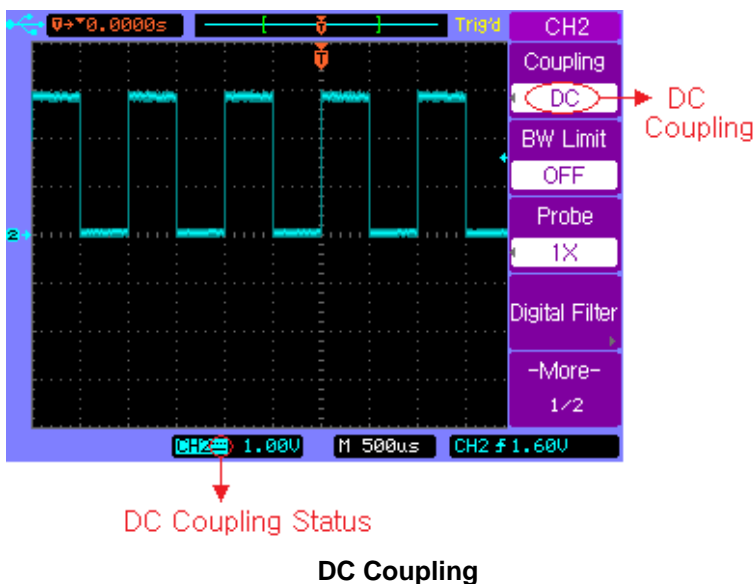

Basic Operation

Press the channel key **CH2**, then press the **Coupling** softkey to select GND coupling mode.

GND mode blocks both AC and DC components of the input signal and connect the input to the ground level.

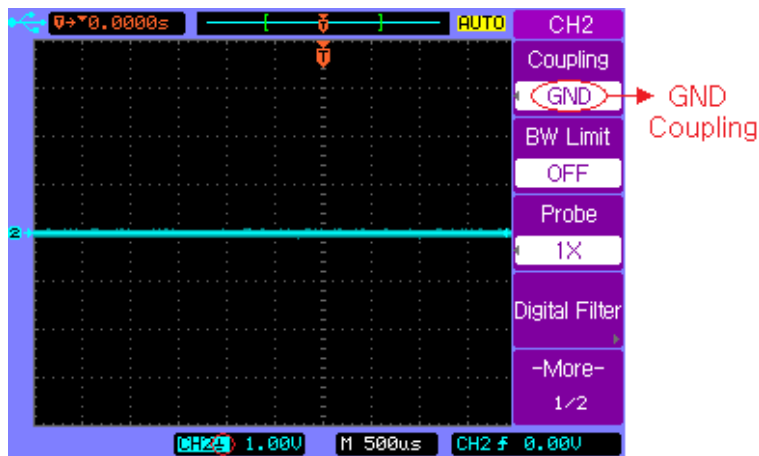

GND Coupling Status

GND Coupling

Basic Operation

BW Limit

When BW Limit is on, the maximum bandwidth for the channel is approximately 20MHz. For waveforms with frequencies below this, turning bandwidth limit on removes unwanted high frequency noise from the waveform. The bandwidth limit also limits the trigger signal path of any channel that has **BW Limit** turned on.

Press the channel key **CH2**, then press the **BW Limit** softkey to turn the bandwidth limit off for the selected channel 2. BW Limit off mode passes both the high and low frequency components.

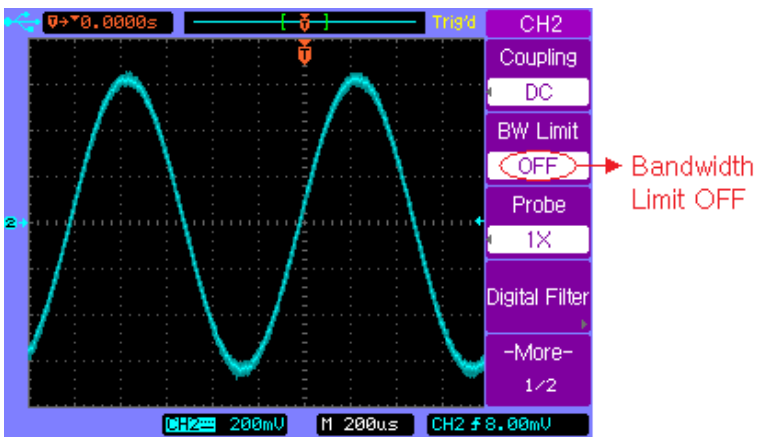

BW Limit off

Basic Operation

Press the channel key **CH2**, then press the **BW Limit** softkey to turn the bandwidth limit on for the selected channel 2. BW Limit on mode blocks the high frequency components over 20MHz.

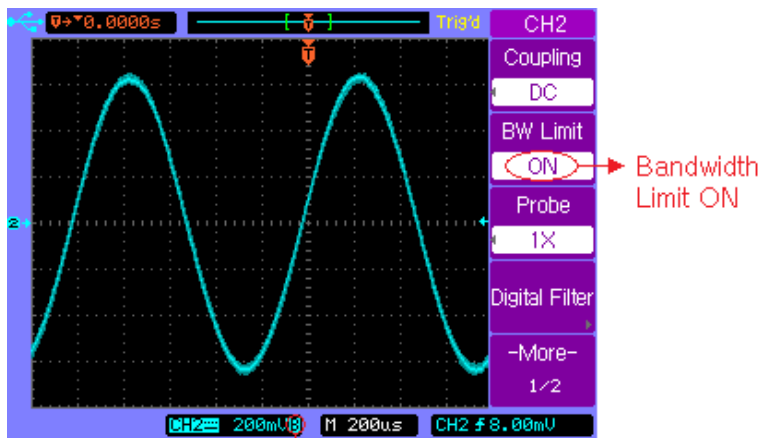

Bandwidth Limit ON Status

BW Limit on

Basic Operation

Probe Attenuation Setting

Probes are available with various attenuation factors which affect the vertical scale of the signal. You can manually select the factor that matches the attenuation of your probe.

For example, to match a probe set to 10X connected to CH2, press the channel key **CH2**, and then press the **Probe** softkey and select 10X.

Press the channel key **CH2**, then press the **Probe** softkey and select 1X, when a probe with 1:1 attenuation factor is connected to CH2.

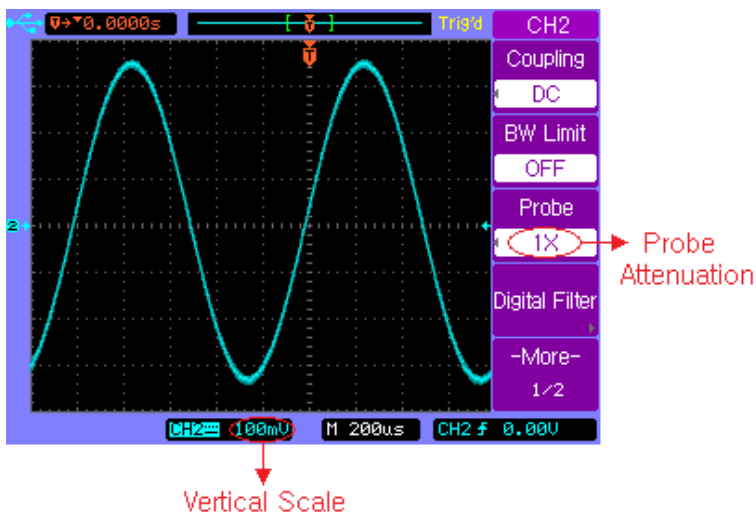



Set Probe Attenuation Factor to 1X

Basic Operation

Digital Filter

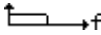
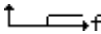
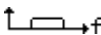
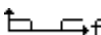
Press the channel key **CH1**, then press the **Digital Filter** softkey to display the **FILTER-CH1** menu. Four kinds of filter types are available:

-  Low pass filter
-  High pass filter
-  Band pass filter
-  Band block filter

Press the **Upper Limit** or **Lower Limit** softkey and then adjust the Entry knob  to set the high and low frequency range for the filter.

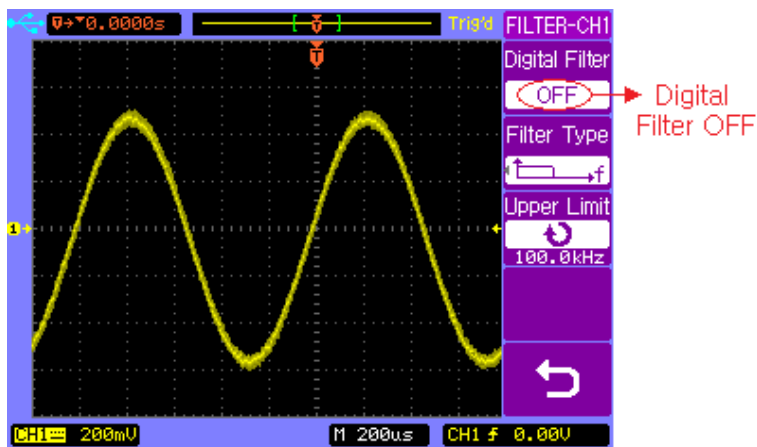

Digital Filter is off

Basic Operation

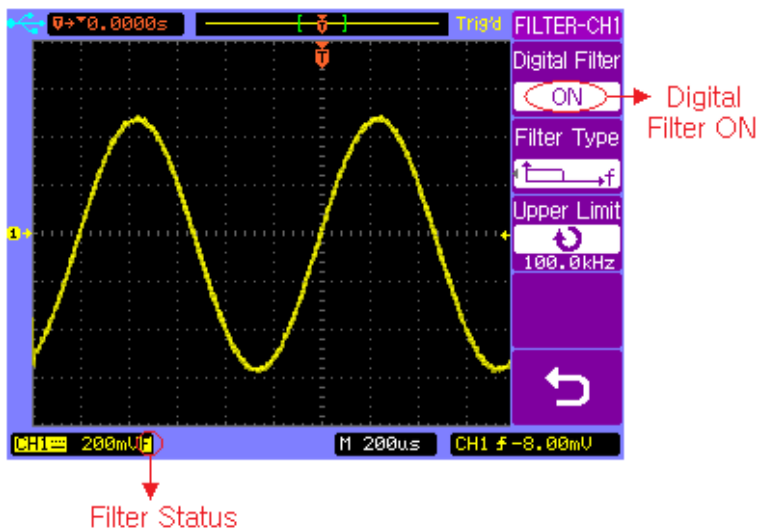

Digital Filter is on

Basic Operation

Vertical Scale

Turn the large vertical scale knob below the channel key to set the scale factor for the channel. The channel scale factor value is displayed in the bottom left portion of the display.

Press **CH2** → **More 1/2** → **Volts Scale** to select **Coarse** or **Fine** adjustment. You can also press the large vertical scale knob to toggle between **Fine** and **Coarse**. When Coarse is selected, the vertical scale knob changes the channel scale in a 1-2-5 step sequence. When Fine is selected, the vertical scale knob changes the channel scale in a smaller resolution.

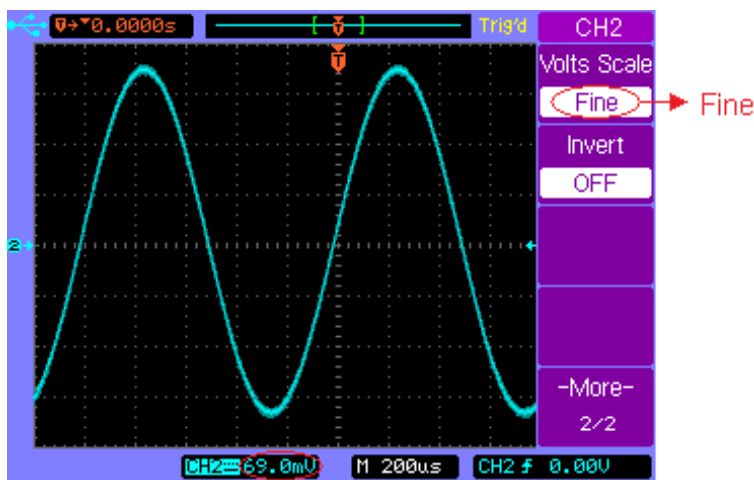

Fine Value

Fine Vertical Scale

Basic Operation

Vertical Invert

Press **CH2** → **More 1/2** → **Invert** to set Invert on or off. When Invert is turned on, the voltage values of the displayed waveform are inverted. Invert affects how a channel is displayed, but does not affect triggering. If the oscilloscope is set to trigger on a rising edge, it remains set to trigger on the same edge after the channel is inverted.

Inverting a channel will also change the result of any math function selected in the **MATH** menu or any measurement.

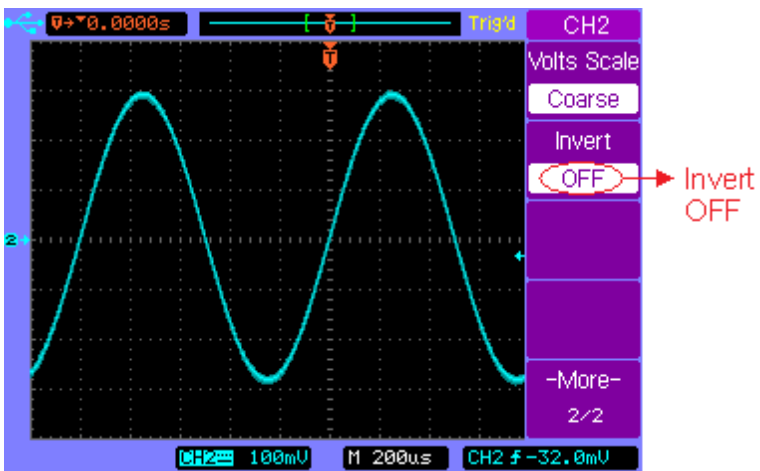

Vertical Invert off

Basic Operation

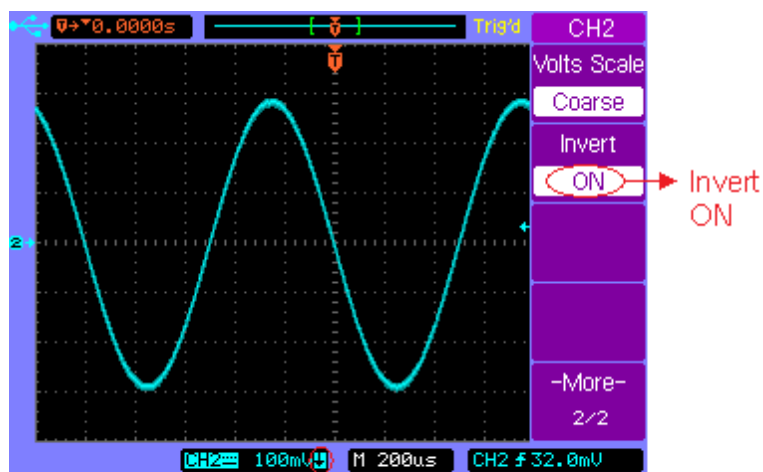

Inversion Status

Vertical Invert on

Basic Operation

MATH Functions







Dual Waveform Calculation

Press **MATH** channel key to turn on the **MATH** menu page 1/2.

MATH	Softkey	Options	Description
Operate	Operate	A+B	Add A and B
A+B		A-B	Subtract B from A
Source A		A×B	Multiply A by B
CH1		FFT	Access FFT menu
Source B	Source A	CH1	Select CH1 as Source A
CH2		CH2	Select CH2 as Source A
Invert	Source B	CH1	Select CH1 as Source B
OFF		CH2	Select CH2 as Source B
-More-	Invert	ON	Math invert ON
1/2		OFF	Math invert OFF
	More 1/2	----	Select page 2/2

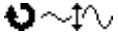
Basic Operation

Press softkey **More 1/2** to display **MATH** menu page 2/2.

MATH	Softkey	Options	Description
Operate	Operate	A+B	Add A and B
A+B		A-B	Subtract B from A
		A×B	Multiply A by B
		FFT	Access FFT menu
Display Mode			Vertical scale control
Full Screen			Vertical position control
-More- 2/2	Display Mode	Split Screen	Split the display into Main and Math sections
		Full Screen	Display Math waveform in full screen
	More 2/2	----	Select page 1/2

Basic Operation

For example, we select the A+B math function, select CH1 as the Source A, and select CH2 as the Source B, then we will get the math waveform like this.

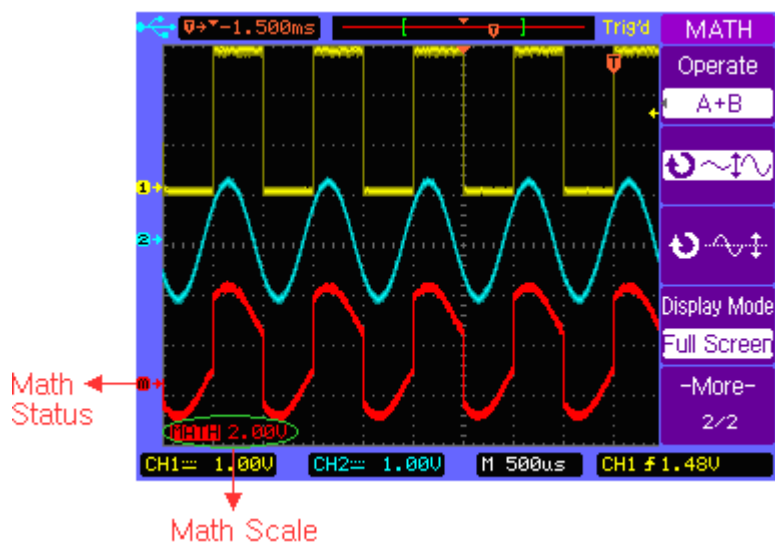

Math A+B

Basic Operation

FFT Spectrum Analysis





You can use the FFT function to measure harmonic component and distortion in systems, to characterize noise in DC power supplies and to analyze vibration.

Press **MATH** channel key to turn on the **MATH** menu page 1/2, and then press **Operate** softkey to select FFT. The **FFT** menu page 1/2 will be displayed.

FFT	Operate	FFT	Source	CH1	Window	Rectangular	Scale	V RMS	-More-	1/2
	Operate	A+B								
		A-B								
		A×B								
		FFT								
	Source	CH1								
		CH2								
	Window	Rectangular								
		Hanning								
		Hamming								
		Blackman								
		Flattop								
	Scale	dBV RMS								
		V RMS								
	More 1/2	----								

Basic Operation

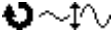
Press softkey **More 1/2** to display **FFT** menu page 2/2.

	Softkey	Options	Description
	Operate	A+B	Add A and B
		A-B	Subtract B from A
		A×B	Multiply A by B
		FFT	Access FFT menu
	Display Mode		Vertical scale control
			Vertical position control
	Display Mode	Split Screen	Split the display into Main and Math sections
		Full Screen	Display Math waveform in full screen
	More 2/2	----	Select page 1/2

Basic Operation

For example, we select CH1 as the source for FFT, select Rectangular window, set vertical scale to dBV RMS, and then we will get the FFT waveform like this. We can also measure the amplitude and frequency of the corresponding point with the manual cursors.

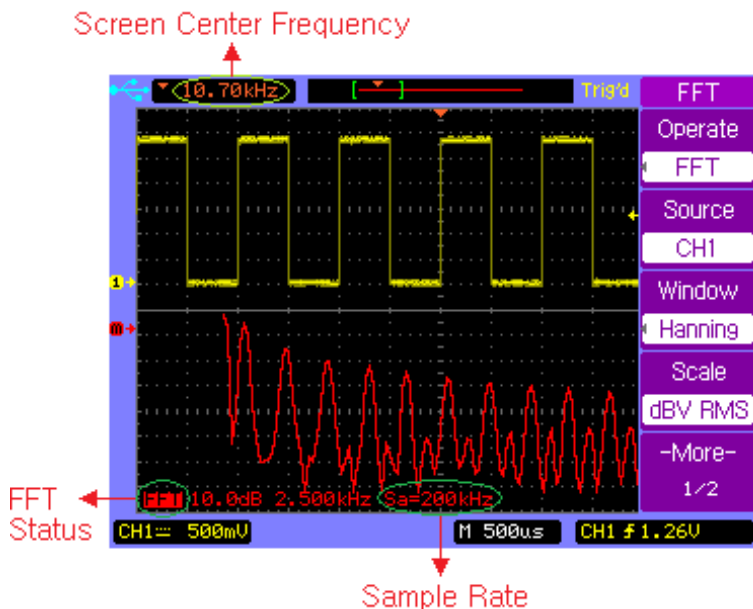

FFT Spectrum Analysis

Basic Operation

REF Function

You might make measurement on a known good system, save the result to the internal memory or to an USB mass storage device, then make the same measurement on a test system and recall the reference waveform to see the difference.

Press **REF** channel key to turn on the **REF** menu page 1/2.

	Softkey	Options	Description
	Source	CH1	Save CH1 as reference
		CH2	Save CH2 as reference
			REF vertical scale control
			REF vertical position control
	Volts Scale	Coarse	Coarse vertical scaling
		Fine	Fine vertical scaling
	More 1/2	----	Select page 2/2

Basic Operation

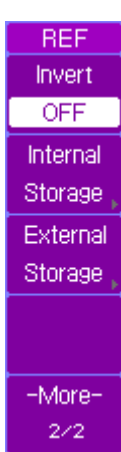

Press softkey **More 1/2** to display **REF** menu page 2/2.

	Softkey	Options	Description
	Invert	ON	REF invert ON
		OFF	REF invert OFF
	Internal Storage	INTERNAL menu	Save the reference waveform to the internal memory.
	External Storage	EXTERNAL menu	Save the reference waveform to the USB mass storage device.
More 2/2	----	Select page 1/2	

Press **REF** channel key to turn on the **REF** menu page 1/2, press softkey **More 1/2** to display **REF** menu page 2/2. Load the latest saved reference waveform from the internal memory or locate and load reference waveform file from the external memory.

You can use the horizontal position and scale control knob to change the time base of the reference waveform.

Basic Operation

Press  or  softkey and turn the Entry knob to change the vertical scale or position of the reference waveform.

Press **REF** → **Internal Storage** → **Save** to save the waveform of the Source channel as the reference waveform to the internal memory.

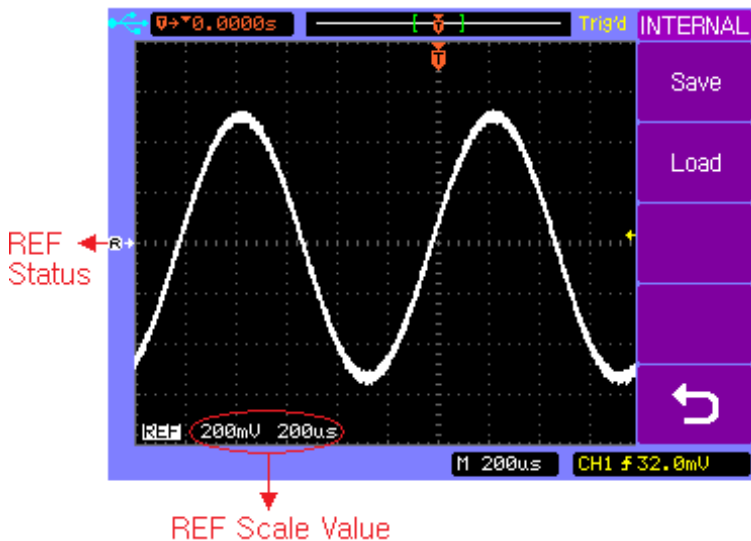

Save a Reference waveform

Note: The reference waveform function is unavailable when X-Y mode is selected.

Basic Operation

Horizontal Controls

Use the horizontal controls to adjust the time base, adjust the trigger location, and to examine waveform details more closely.

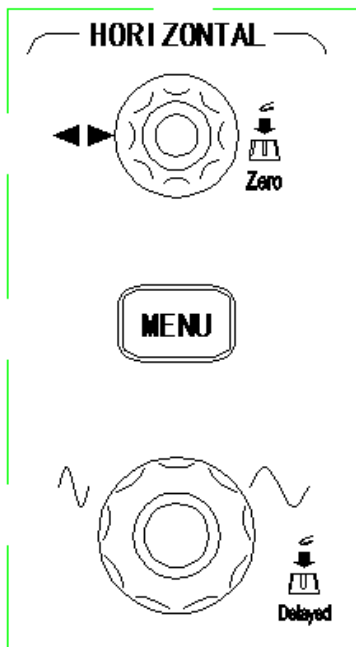



Horizontal Controls



Basic Operation

Horizontal Position Control

When the oscilloscope is running, this control lets you set the acquisition window relative to the trigger point. When the oscilloscope is stopped, you can turn this knob to pan through the data horizontally. This lets you see the captured waveform before the trigger or after the trigger.

The trigger position is marked with the indicator “” at the top of the graticule and also in the waveform record icon at the top of the screen.

The small inverted triangle () is the time reference indicator. When you change the horizontal scale, the waveforms contract or expand about this point.

Press the horizontal position control knob key to set the time delay to zero, and the trigger position indicator () overlays the time reference indicator()

Note: The horizontal position control is unavailable when X-Y horizontal mode is selected.

Horizontal Scale Control

Use the horizontal scale control to adjust the time base. The scale expands or contracts around the center of the screen. The horizontal scale factor can be set in a 1-2-5 sequence.

Basic Operation

Press the horizontal scale control knob to toggle between Main and Delayed horizontal display mode.

Horizontal **MENU** key

Press the horizontal **MENU** key to display the **HORIZONTAL** menu. This menu lets you select the horizontal mode: **Main**, **Delayed**, **Roll**, or **X-Y**.

Press the horizontal **MENU** key to display the **HORIZONTAL** menu page 1/2.

HORIZONTAL	Softkey	Options	Description
Main ✓	Main	√	Main mode is ON
		----	Main mode is OFF
Delayed	Delayed	√	Delayed mode is ON
		----	Delayed mode is OFF
X-Y	X-Y	√	X-Y mode is ON
		----	X-Y mode is OFF
Roll	Roll	√	Roll mode is ON
		----	Roll mode is OFF
-More- 1/2	-More- 1/2	----	Select page 2/2

Basic Operation

Press softkey **More 1/2** to display the **HORIZONTAL** menu page 2/2.

HORIZONTAL Trig-Offset Reset	Softkey	Options	Description
	Trig-Offset Reset	----	Reset the delay time to zero.
	-More- 2/2	----	Select page 1/2



Main Horizontal Mode

Main horizontal mode is the normal viewing mode for the oscilloscope. When the oscilloscope is stopped, you can use the horizontal controls to pan and zoom the waveform. When the oscilloscope is running in Main mode, use the horizontal scale knob to change horizontal scale factor and use the horizontal position knob to set the delay time. When the oscilloscope is stopped, use the horizontal control knobs to pan and zoom the waveform. The time base (second/division) value is displayed at the bottom of the screen.

Press the horizontal **MENU** key and then press the **Main** softkey to select the main horizontal mode.

Basic Operation

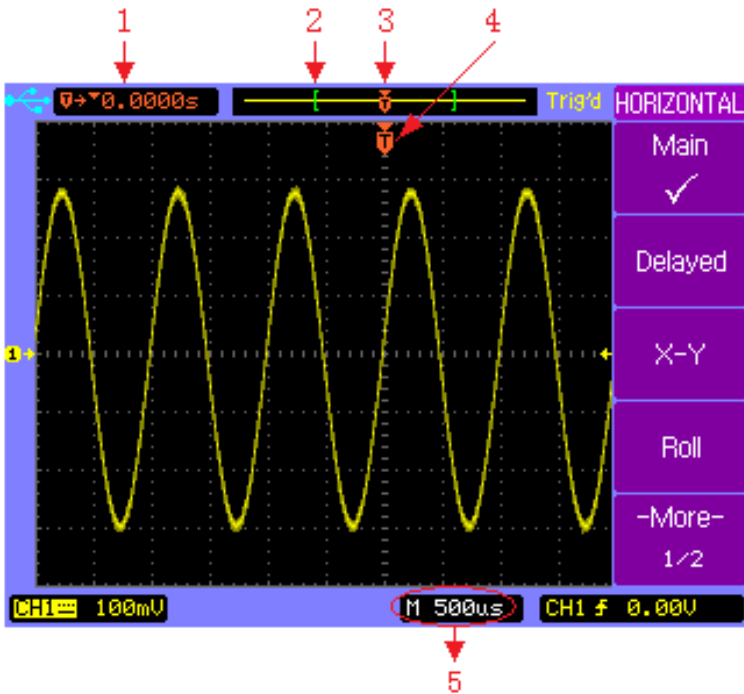

Main Horizontal Mode

1. Readout shows the delay time or the trigger location within the record relative to the time reference point (\blacktriangleright).
2. The square brackets show the location of current display window within the record.
3. Trigger position within the record.
4. Trigger position on the current waveform display window.
5. Main time base.

Basic Operation

Delayed Horizontal Mode

Delayed horizontal mode is an expanded version of main mode. When Delayed mode is selected, the display divides in half. The top half of the display shows the normal waveform and bottom half displays the delayed waveform.

Delayed waveform is a magnified portion of the normal waveform. You can use delayed waveform to locate and horizontally expand part of the normal waveform for a more detailed analysis of signals.

The area of the normal display that is expanded is marked on each end with a vertical shadow area. The unshadowed area shows what portion of the normal waveform is expanded in the lower half.

To change the time base for the delayed window, turn the horizontal scale knob. As you turn the knob, the time base for the delayed window is displayed just above the main time base.

To change the time base for the normal window, press the Main softkey, then turn the horizontal scale control knob.

Connect a triangle signal source to CH1, press the horizontal **MENU** key and then press the **Delayed** softkey to enter the Delayed mode. You can also press the horizontal scale

Basic Operation

control knob key to toggle between Main and Delayed mode directly.

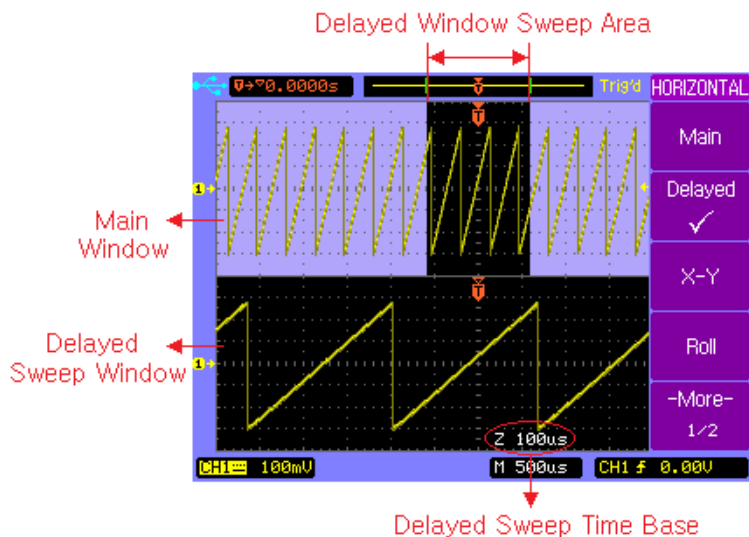

Delayed Horizontal Mode

Basic Operation

X-Y Horizontal Mode

X-Y mode changes the display from a volts-versus-time display to a volts-versus-volts display. The time base is turned off. CH1 amplitude is plotted on the X axis and CH2 amplitude is plotted on the Y axis.

You can use X-Y mode to compare frequency and phase relationships between two signals. X-Y mode can also be used with transducers to display strain versus displacement, flow versus pressure, volts versus current, or voltage versus frequency.

In order to get a better view of the waveform, proper vertical scale should be selected before enter the X-Y mode.

Use X-Y mode to compare two signal with same frequency and different phase. Connect the two signal to CH1 and CH2 respectively. Press horizontal **MENU** key and then **X-Y** softkey to select X-Y mode.

Basic Operation

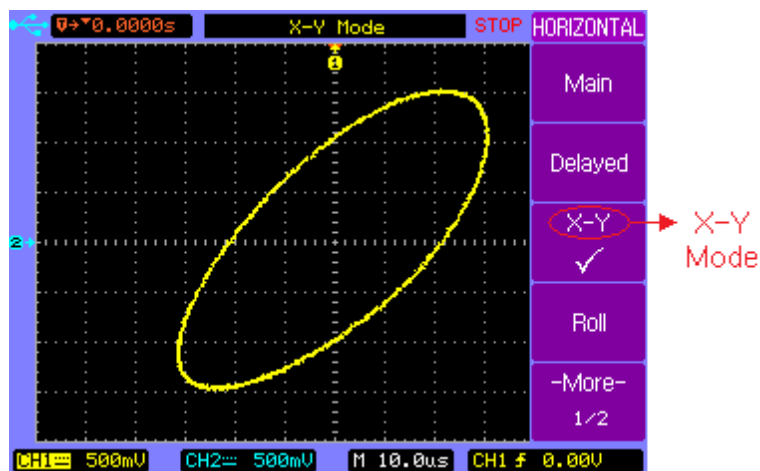

X-Y Horizontal Mode

Basic Operation

Roll Horizontal Mode

Roll mode causes the waveform to move slowly across the screen from right to left. It only operates on time base settings of 500 ms/div or slower. If the current time base setting is faster than the 500 ms/div limit, it will be set to 500ms/div when Roll mode is selected.

In Roll mode there is no trigger. The fixed reference point on the screen is the right edge of the screen and refers to the current moment in time. Events that have occurred are scrolled to the left of the reference point. Since there is no trigger, no pre-trigger information is available.

If you would like to pause the display after a full screen of acquisition in Roll mode, press the **SINGLE** key. To clear the display and restart another full screen acquisition in Roll mode, press the **SINGLE** key again.

Use Roll mode on low-frequency waveforms to yield a display much like a strip chart recorder. It allows the waveform to roll across the display.

Press the horizontal **MENU** key and then press the **Roll** softkey to select the Roll mode. The waveform moves slowly across the screen from right to left. The fastest time base is 500 ms in roll mode.

Basic Operation

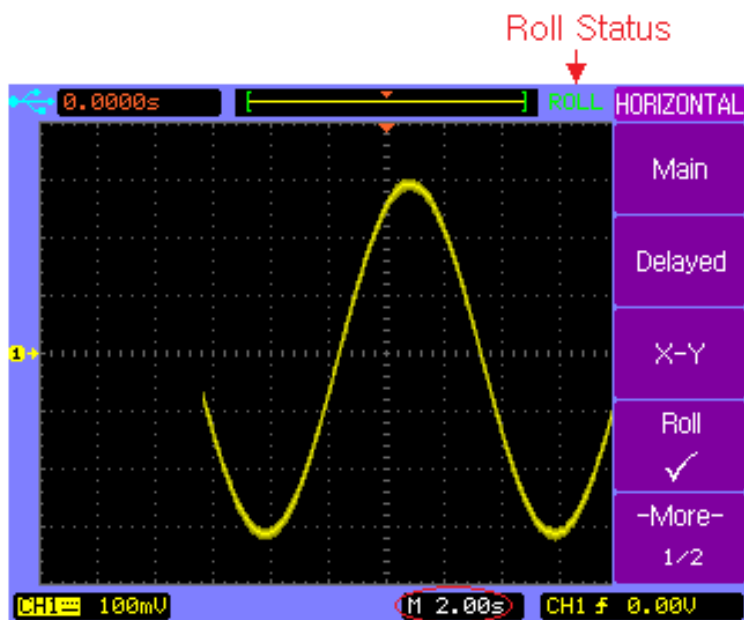

Horizontal Time Base

Roll Horizontal Mode

Basic Operation

Trigger Controls

The trigger controls determine when the oscilloscope starts to acquire and display the waveform. When a trigger is found, the oscilloscope will acquire sufficient data to display the waveform. Trigger controls are functional when the oscilloscope works under Main or Delayed horizontal mode.

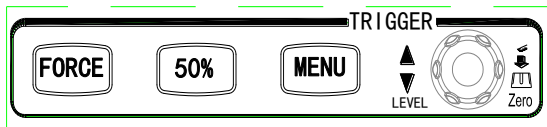

Trigger Controls

Basic Operation

Trigger Control **MENU** key

Press the trigger control **MENU** key to show the **TRIGGER** menu and then press the **Type** softkey to select Edge, Pulse or Video.

Set to 50% key

Press the **50%** key to set the trigger level to the 50% amplitude level of the trigger source waveform.

Force Trigger key

Press the **FORCE** key to force an immediate trigger event, even in the absence of a signal. This function is useful in following situations.

If you do not see a waveform on the screen when using Normal trigger mode, press the **FORCE** key to acquire the signal baseline to verify that it is on the screen.

After you press the **SINGLE** key to set up for a single shot acquisition, you can press the **FORCE** key to do a practise acquisition to verify the control settings.

Trigger Level Control

Use the trigger level control knob to adjust the trigger level. When you change the trigger level, a horizontal red line temporarily appears to show you the level position on screen.

Basic Operation

After the line disappears, the trigger level is marked with a small left arrow.

Auto and Normal Trigger Modes

Press the trigger **MENU** key to display the **TRIGGER** menu and press the **Mode** softkey to select Auto or Normal trigger mode.

Auto mode

Use the auto trigger mode for signals other than low-repetitive-rate signals and for unknown signal levels. To display a DC signal, you must use Auto trigger mode since there is no edge to trigger on.

When you press **RUN/STOP** key to start acquiring, the oscilloscope first fill the pre-trigger buffer. It starts to search for a trigger after the pre-trigger buffer is filled, and continues to flow data through this buffer while it searches for the trigger. While searching for the trigger, the oscilloscope overflows the pre-trigger buffer; the first data put into the buffer is the first pushed out. When a trigger is found, the pre-trigger buffer will contain the events that occurred just before the trigger. If no trigger is found, the oscilloscope generates a trigger and displays the data as though a trigger had occurred. In this case, the background of the Auto indicator at the top of the display will flash, indicating that the oscilloscope is force triggered.

Basic Operation

When you press the **SINGLE** key, the oscilloscope will fill the pre-trigger buffer, and continue to flow data through the pre-trigger buffer until the Auto trigger overrides the searching and forces a trigger. At the end of the trace, the oscilloscope will stop and display the results.

Normal mode

Use Normal trigger mode for low repetitive-rate signals or when Auto trigger is not required.

In Normal mode the oscilloscope must fill the pre-trigger buffer with data before it will begin searching for a trigger event. While searching for the trigger, the oscilloscope overflows the pre-trigger buffer; the first data put into the buffer is the first pushed out.

When the trigger event is found, the oscilloscope will fill the post-trigger buffer and display the results. If the acquisition was initiated by **RUN/STOP**, the process repeats. If the acquisition was initiated by **SINGLE**, then the acquisition stops.

In either Auto or Normal mode, the trigger may be missed. This is because the oscilloscope will not recognize a trigger event until the pre-trigger buffer is full.

Basic Operation

Holdoff Function

Holdoff sets the amount of time that the oscilloscope will wait before rearming the trigger circuit. You can use the holdoff function to stabilize the display of complex waveforms.

With the holdoff function, you can synchronize triggers. The oscilloscope will trigger on one edge of the waveform, and ignore further edges until the holdoff time is up. The oscilloscope will then rearm the trigger circuit to wait for the next edge trigger. This allows the oscilloscope to trigger on a repeating pattern in a waveform.

Turn the Entry knob to increase or decrease the trigger hold off time shown in the Holdoff softkey.

To get a stable trigger on the pulse burst shown on the screen, set the holdoff time to be slightly less than the period of the pulse burst.

Basic Operation

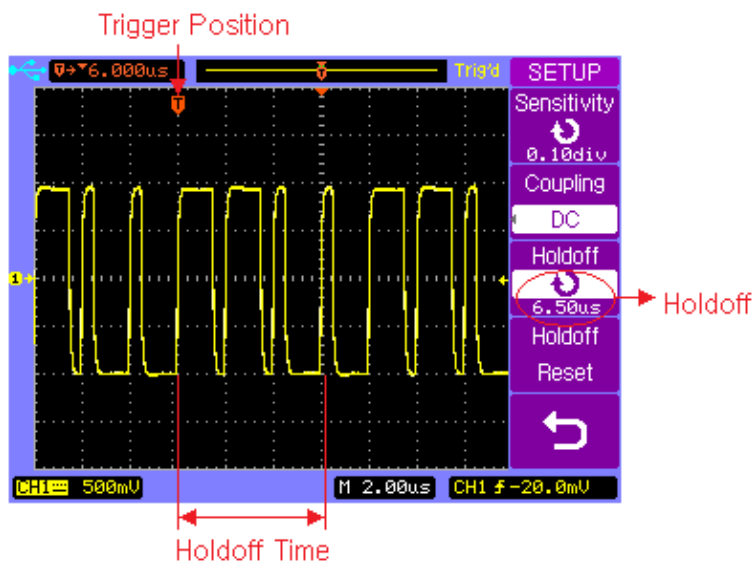

Holdoff Function

Basic Operation

Edge Trigger

Use the Edge triggering to trigger on the rising or falling edge of the input signal at the trigger threshold.

Basic Operation

Press trigger control **MENU** key to display the **TRIGGER** menu, then press **Type** softkey to select Edge trigger.

TRIGGER	Softkey	Options	Description
Type	Type	Video	Video triggering
Edge		Edge	Edge triggering
Source		Pulse	Pulse width triggering
CH1	Source	CH1	Trigger on CH1
Slope		CH2	Trigger on CH2
Auto		EXT	Trigger on EXT
Trigger Setup		EXT/5	Trigger on EXT/5
		AC Line	Trigger on AC line signal
		Alternating	Trigger on CH1 and CH2 alternately
	Slope	⤴	Rising edge of a signal
		⤵	Falling edge of a signal
	Mode	Auto	Trigger even without a valid event.
		Normal	Trigger only on a valid event
	Trigger Setup	----	Select trigger SETUP menu.

Basic Operation

Pulse Width Trigger

Pulse width triggering sets the oscilloscope to trigger on a positive or negative pulse of a specified width from 20ns to 10s.

Basic Operation

Press trigger control **MENU** key to display the **TRIGGER** menu page 1/2, then press **Type** softkey to select Pulse trigger.



Softkey	Options	Description
Type	Video	Video triggering
	Edge	Edge triggering
	Pulse	Pulse width triggering
Source	CH1	Trigger on CH1
	CH2	Trigger on CH2
	EXT	Trigger on EXT
	EXT/5	Trigger on EXT/5
	Alternating	CH1 and CH2 alternately
Pulse Mode		Positive greater than
		Positive equal
		Positive within
		Positive less than
		Negative greater than
		Negative equal
		Negative within
		Negative less than
Pulse Setup		Set the pulse width
More 1/2	----	Select page 2/2

Basic Operation

Press trigger control **MENU** key to display the **TRIGGER** menu, press **Type** softkey to select Pulse trigger and then press the **More 1/2** softkey to display **TRIGGER** menu page 2/2.

	Softkey	Options	Description
	Type	Video	Video triggering
		Edge	Edge triggering
		Pulse	Pulse width triggering
	Mode	Auto	Trigger even without a valid event.
		Normal	Trigger only on a valid event
	Trigger Setup	----	Select trigger SETUP menu.
	More 2/2	----	Select page 1/2



Basic Operation

Video Trigger

Choose video triggering to trigger on the odd fields, even fields, or on all the lines of a NTSC, PAL/SECAM video signal.

Basic Operation

Press trigger control **MENU** key to display the **TRIGGER** menu, then press **Type** softkey to select Video trigger.

TRIGGER	Softkey	Options	Description
Type	Type	Video	Video triggering
Video		Edge	Edge triggering
Source		Pulse	Pulse width triggering
CH1	Source	CH1	Trigger on CH1
Polarity		CH2	Trigger on CH2
		EXT	Trigger on EXT
Sync		EXT/5	Trigger on EXT/5
Line # No. 6		Alternating	Trigger on CH1 and CH2 alternately
-More- 1/2	Polarity		Positive polarity
			Negative polarity
	Sync	Odd Field	Trigger on odd fields
		Even Field	Trigger on even fields
		All Lines	Trigger on all lines
		Line #	Trigger on specific line.
	More 1/2	----	Select page 2/2

Basic Operation

Press softkey **More 1/2** to display the **TRIGGER** menu page 2/2.

TRIGGER	Softkey	Options	Description
Type	Type	Video	Video triggering
Video		Edge	Edge triggering
Standard		Pulse	Pulse width triggering
NTSC	Standard	NTSC	Trigger on NTSC signal
Mode		PAL/SECAM	Trigger on PAL or SECAM signal
Auto	Mode	Normal	Trigger only on a valid event
Trigger Setup		Auto	Trigger even without a valid event
-More- 2/2	Trigger Setup	----	Select trigger SETUP menu.
	More 2/2	----	Select page 1/2

Basic Operation

Press softkey **Trigger Setup** from the **TRIGGER** menu page 2/2 to display the trigger **SETUP** menu.

SETUP	Softkey	Options	Description
Sensitivity 0.10div	Sensitivity	↻	Set the trigger sensitivity by turning the entry knob
Coupling DC	Coupling	AC	AC coupling
Holdoff 100ns		DC	DC coupling
Holdoff Reset		LF Reject	Reject low frequencies
↶		HF Reject	Reject high frequencies
↻	Holdoff	↻	Set up the holdoff time between two consecutive triggers
↻	Holdoff Reset	----	Reset the holdoff time to default value 100ns
↶	↻	----	Return to the TRIGGER menu

Note: You can display the trigger **SETUP** menu simply by pressing the short-cut key **TRIGSET** directly.

Note: There will be no coupling menu item when video trigger mode is selected in the trigger **SETUP** menu.

Basic Operation

Following figures show the video waveforms triggered on odd fields and specific line 6.

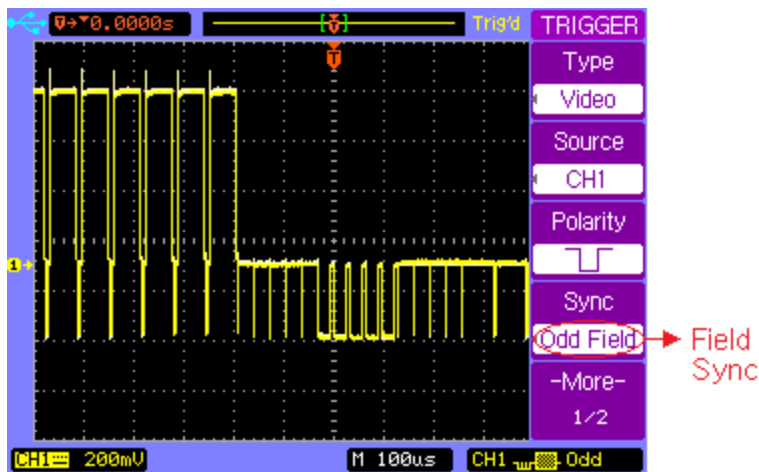

Trigger on odd fields

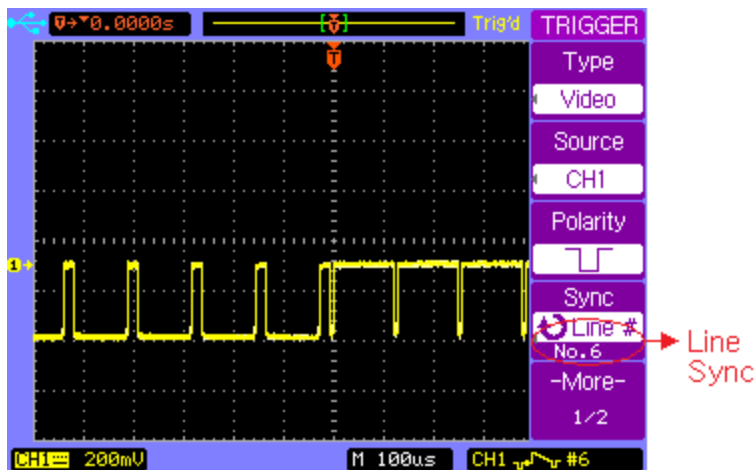

Trigger on specific line 6

Basic Operation

ACQUIRE Menu

Press the **ACQUIRE** menu key to show the **ACQUIRE** menu.

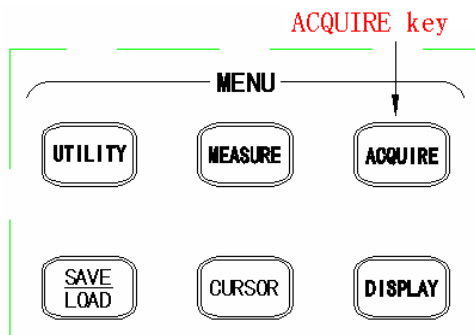

ACQUIRE Menu key

Normal acquisition mode yields the best display for most waveforms.

Average mode lets you average multiple triggers to reduce noise and increase resolution.

Peak Detect mode should be used to display narrow pulses that occur infrequently. It's useful when looking for very narrow pulses at very slow time base.

Equivalent sampling mode is useful to display high frequency repetitive signals.

Real Time sampling mode is useful to capture the single-shot signals.

Basic Operation

Press **Mode** softkey to select **Normal** mode.

	Softkey	Options	Description
ACQUIRE	Mode	Normal	Normal acquisition.
Mode		Average	Average acquisition.
Normal		Peak Detect	Peak detect acquisition
	Sampling	Equivalent	Equivalent sampling.
Sampling		Real Time	Real time sampling.
Equivalent			
	Record	----	Select Record menu
Record			

Basic Operation

Press **Mode** softkey to select **Average** mode.

	Softkey	Options	Description
	Mode	Normal	Normal acquisition.
		Average	Average acquisition.
		Peak Detect	Peak detect acquisition
	Averages	↻	Set the average number to 2, 4, 8, 16, 32, 64, 128, or 256.
	Sampling	Equivalent	Equivalent sampling.
Real Time		Real time sampling.	
Record	----	Select Record menu	

Press **Mode** softkey to select **Peak Detect** mode.

	Softkey	Options	Description
	Mode	Normal	Normal acquisition.
		Average	Average acquisition.
		Peak Detect	Peak detect acquisition
	Sampling	Equivalent	Equivalent sampling.
		Real Time	Real time sampling.
Record	----	Select Record menu	

Basic Operation

Connect a sine signal to the CH1 channel, press **ACQUIRE** → **Mode** to select Average mode. Turn the Entry knob to set the number of averages to 16. The following two figures show the difference between Normal acquisition and Average acquisition.

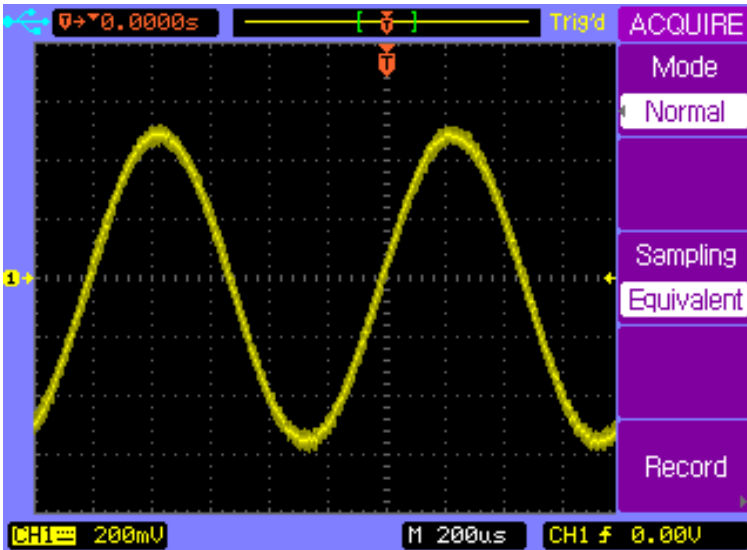

Random noise on the displayed waveform

Basic Operation

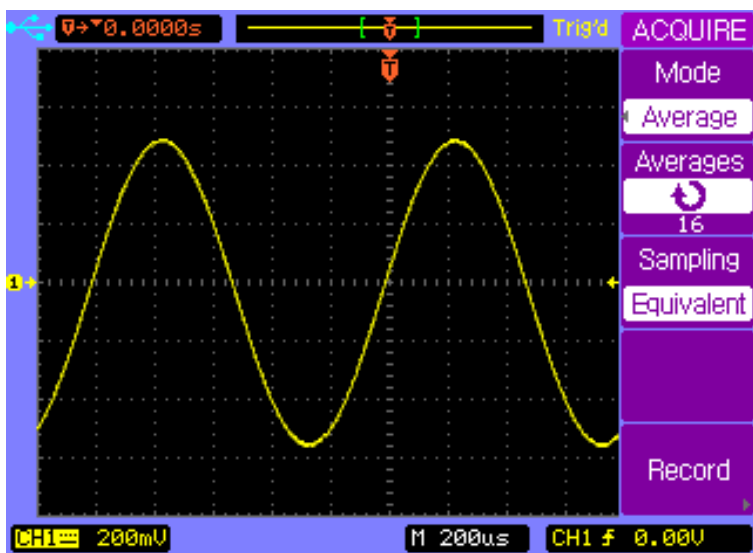

16 Averages used to reduce random noise

Basic Operation

Record the Waveform

Press **ACQUIRE** → **Record** to show the **RECORD** menu.



Softkey	Options	Description
Mode	Record	Record the waveform
	Play Back	Play back the record
	Save /Recall	Save/Recall from internal or external memory.
	OFF	Exit Record function
Source	CH1	Record CH1 channel
	CH2	Record CH2 channel
	Pass/Fail Out	Record Pass/Fail output waveform
Interval	↻	Set the time interval
End Frame	↻	Maximum record frame
Operate	●	Record
	■	Stop

Basic Operation

Play Back the Record

Press **ACQUIRE** → **Record** to show the **RECORD** menu.

Press **Mode** softkey to select Play Back function.



Softkey	Options	Description
Mode	Record	Record the waveform
	Play Back	Play back the record
	Save /Recall	Save/Recall from internal or external memory.
	OFF	Exit Record function
Operate	▶	Play
	■	Stop
Play Mode		Loop play
		Single play
Current Frame		Select a specific frame
More 1/2	----	Select menu page 2/2

Basic Operation

Press **ACQUIRE** → **Record** to show the **RECORD** menu.
 Press **Mode** softkey to select Play Back function. Press **More**
1/2 softkey to show **RECORD** menu page 2/2.



Softkey	Options	Description
Interval	↻	Interval between two frames
Start Frame	↻	Set the start frame to playback.
End Frame	↻	Set the end frame to playback.
Msg Display	ON	Record message on
	OFF	Record message off
More 2/2	----	Select menu page 1/2

Note: *The interval time must be greater than 1ms + signal period + sampling interval time + frame storage time .*

Note: *Frame length is the waveform storage depth. Maximum 1000 frames of waveform can be stored.*

Basic Operation

Save/Recall the Record

Press **ACQUIRE** → **Record** to show the **RECORD** menu.

Press **Mode** softkey to select **Save/Recall** function.

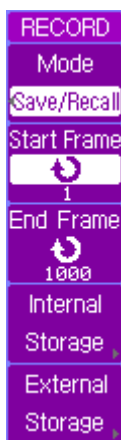



Softkey	Options	Description
Mode	Record	Record the waveform
	Play back	Play back the record
	Save /Recall	Save/Recall from internal or external memory.
	OFF	Exit Record function
Start Frame	↻	Set the start frame to save.
End Frame	↻	Set the end frame to save.
Internal Storage	----	Save/Recall from internal memory.
External Storage	----	Save/Recall from external memory.

Basic Operation

Exit Record Function

Press **Mode** softkey to select **OFF** option and return to the **ACQUIRE** menu.

RECORD Mode OFF	Softkey	Options	Description
Mode		Record	Record the waveform
		Play back	Play back the record
		Save /Recall	Save/Recall from internal or external memory.
		OFF	Exit Record function
		---	Return to ACQUIRE menu

Basic Operation

UTILITY Menu

Press the **UTILITY** menu key to show the **UTILITY** menu.

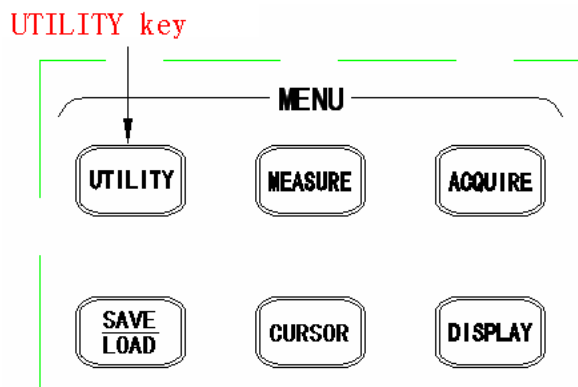

UTILITY Menu key

Basic Operation

Press the **UTILITY** key to display the **UTILITY** menu page 1/2.

UTILITY	Softkey	Options	Description
I/O Setup	I/O Setup	----	Select I/O SETUP menu
Print Setup	Print Setup	----	Select PRINT menu
System Setup	System Setup	----	Select SYETEM menu
Language	Language	简体中文	Simplified Chinese
English		繁體中文	Traditional Chinese
-More-		English	English language
1/2		한국어	Korean language
		日本語	Japanese language
		Русский	Russian language
		Français	French language
		Español	Spanish language
		Polski	Persian language
		Português	Portuguese language
	More 1/2	----	Select menu page 2/2

Basic Operation

Press the **More 1/2** softkey to display the **UTILITY** menu page 2/2.

UTILITY	Softkey	Options	Description
Service	Service	----	Select Service menu
Pass/Fail	Pass/Fail	----	Select PASS/FAIL menu
Self-Cal	Self-Cal	RUN/STOP	Start self-calibration
Fast-Cal		AUTO	Exit self-calibration.
Fast-Cal	Fast-Cal	ON	Fast calibrate the vertical position.
OFF		OFF	Close the fast calibration.
-More- 2/2	More 2/2	----	Select menu page 1/2

Basic Operation





I/O Setup

Press **UTILITY** → **I/O Setup** to display the **I/O SETUP** menu.

I/O SETUP	Softkey	Options	Description
Type		USB Device	Select USB IF
LAN	Type	RS232C	Select RS232C IF
Network Settings		LAN	Select LAN IF
	Baud Rate	↻	Available baud rate: 2400, 4800, 9600, 19200, 38400
	Network Settings	----	Select LAN menu (B series only)
↶	↻	----	Return to the UTILITY menu

Basic Operation

Press **Network Settings** softkey to display the **LAN** menu.

LAN	Softkey	Options	Description
DHCP	DHCP	ON	IP address together with subnet mask and gateway address will be set by DHCP server automatically.
OFF		OFF	You have to set IP address, subnet mask and gateway address manually.
↑ ↓	↑ ↓	----	Move the cursor position vertically.
		----	Move the cursor position horizontally.
OK	OK	----	Confirm and apply the current settings.
		----	Return to the I/O SETUP menu

Basic Operation

Follow the following steps to manually configure the LAN interface:

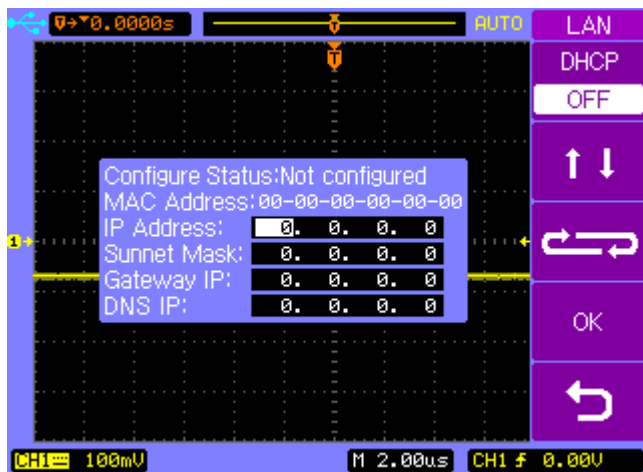

- **Set the IP Address.** Contact your network administrator for the IP address to use. All IP addresses take the dot-notation form “nnn.nnn.nnn.nnn” where “nnn” in each case is a byte value in the range 0 through 255. Move the cursor to the IP address position and change the IP address using the entry knob.
- **Set the Subnet Mask.** The subnet mask is required if your network has been divided into subnets. Move the cursor to the subnet mask position and enter the subnet mask in the IP address format using the entry knob.
- **Set the Gateway IP.** The gateway address is the address of a gateway which is a device that connects two

Basic Operation



networks. Move the cursor to the Gateway IP position and enter the gateway address in the IP address format using the entry knob.

- **Set the DNS IP.** DNS is an internet service that translates domain names into IP addresses. Move the cursor to the DNS IP position and enter the address of the DNS server in the IP address format using the entry knob.

Basic Operation

Print Setup

Press **UTILITY** → **Print Setup** to display the **PRINT** menu.

	Softkey	Options	Description
PRINT	Print to	File	Print to file
Print to File			
File Type	File Type	BMP(8Bit)	8-Bit BMP file format
BMP(24Bit)		BMP(24Bit)	24 Bit BMP file format
Screen		CSV	CSV file format
Normal	Screen	Normal	Normal BMP picture
		Inverted	Inverted color BMP picture
		----	Return to the UTILITY menu

Connect an USB mass storage device to the USB host connector on the front panel.

Press **File Type** softkey to select the file format you want.





Press the **PRINT** key to save the file to the USB mass storage device.

Basic Operation

System Setup

Press **UTILITY** → **System Setup** to display the **SYSTEM** menu page 1/2.



Softkey	Options	Description
Key Sound		Key press sound on
		Key press sound off
Alarm Sound		Alarm sound on
		Alarm sound off
Counter	ON	Frequency counter on
	OFF	Frequency counter off
More 1/2	----	Select menu page 2/2

Basic Operation

Press the **More 1/2** softkey to display the **SYSTEM** menu page 2/2.

<div style="background-color: #800080; color: white; padding: 2px; text-align: center;">SYSTEM</div> <div style="background-color: #800080; color: white; padding: 2px; text-align: center;">Key Lock</div> <div style="background-color: #800080; color: white; padding: 2px; text-align: center;">OFF</div> <div style="background-color: #800080; color: white; padding: 2px; text-align: center;">Password</div> <div style="background-color: #800080; color: white; padding: 2px; text-align: center;">ON</div> <div style="background-color: #800080; color: white; padding: 2px; text-align: center;">Change Password</div> <div style="background-color: #800080; color: white; padding: 2px; text-align: center;">↶</div> <div style="background-color: #800080; color: white; padding: 2px; text-align: center;">-More- 2/2</div>	Softkey	Options	Description
	Key Lock	ON	Key Lock function on
		OFF	Key Lock function off, a password is required when Password is ON.
	Password	ON	Password protection on
		OFF	Password protection off, a password is required when Password is ON.
	Change Password		The old password is required to change the password.
↶	----	Return to the UTILITY menu	
More 2/2	----	Select menu page 1/2	

Note: The default password is “111111”

Basic Operation

Press **UTILITY** → **System Setup** → **Key Lock** to lock the front panel operation, all the keys and controls are disabled except **MENU ON/OFF** key and the five softkeys. When front panel is locked a red lock icon is displayed at the top-left corner of the screen. Correct password is required to unlock the front panel operation when Password is ON as shown below. The default password is “111111”.

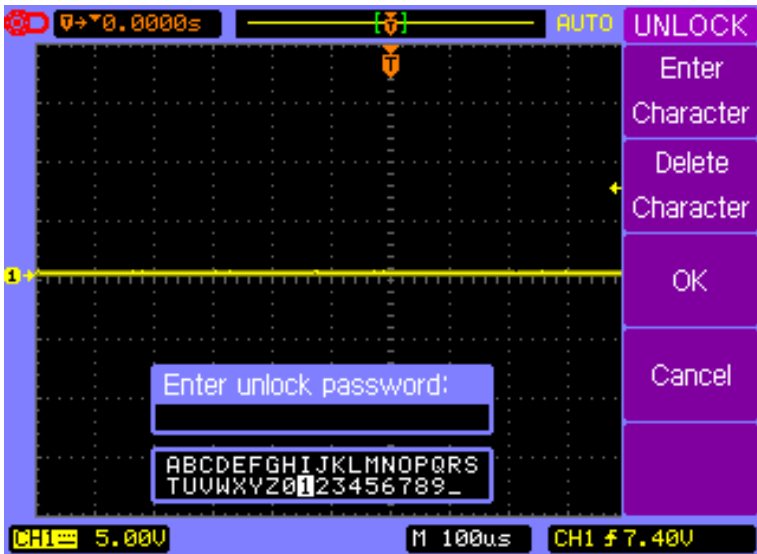

Basic Operation

Press **Password** softkey from the **SYSTEM** menu 2/2 to to turn off the Password protection function, correct password is required as shown below.

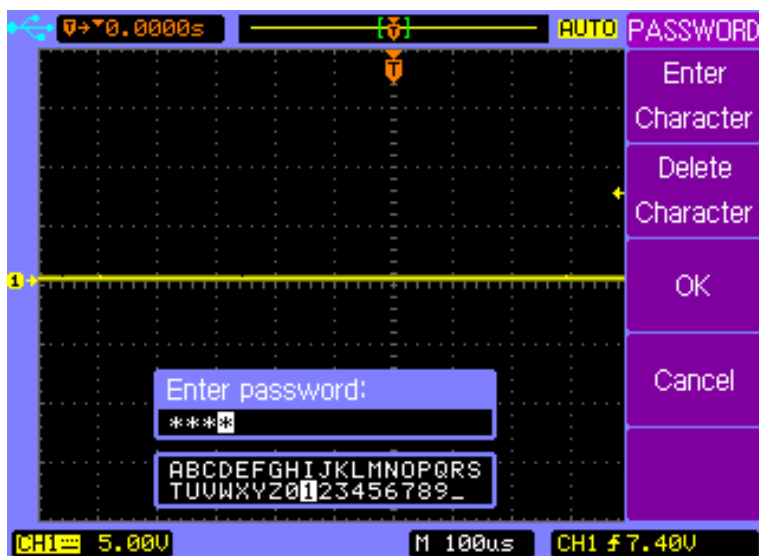

Basic Operation

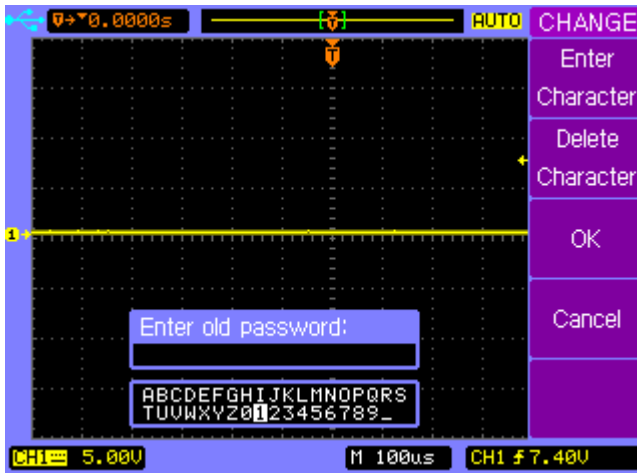

Press **Change Password** softkey from the **SYSTEM** menu page 2/2 to display the **CHANGE** menu. The old password is required before entering the new password and confirming the new password as shown below.



Basic Operation

Service

Press **UTILITY** → **Service** to display the **Service** menu.

SERVICE	Softkey	Options	Description
System Info	System Information	----	Display system information: Model, Serial number, Software version, Installed modules.
Screen Test	Screen Test	----	Test the LCD screen
Key Test	Key Test	----	Check the key and control operation.
		----	Return to the UTILITY menu

Basic Operation

Press **UTILITY** → **Service** to display the **Service** menu, and then press the **System Info** softkey to display the system informations, such as Model, Serial number, Power up times, Software version and a list of installed modules.

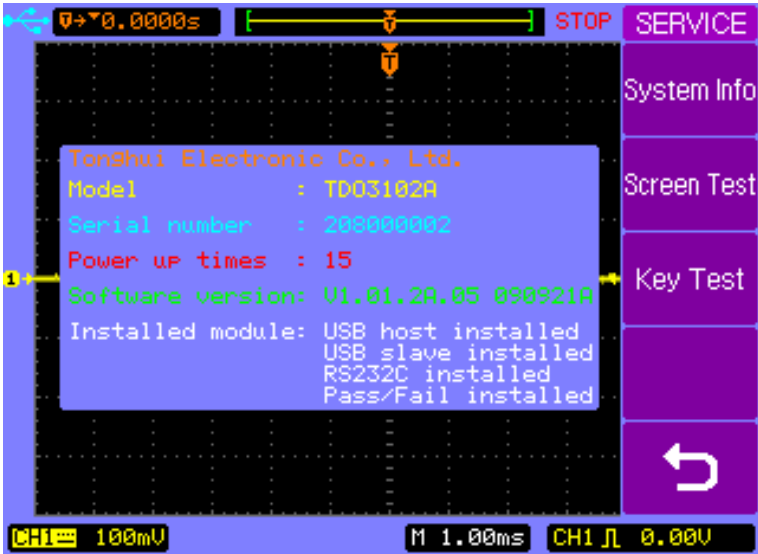

System Information

Basic Operation

Pass/Fail

The oscilloscope first measures the input source signal and compares it with Pass/Fail regulations and then outputs the Pass/Fail result.

Press **UTILITY** → **Pass/Fail** to display the **PASS/FAIL** menu 1/2.

Softkey	Options	Description
Enable Test	ON	Pass/Fail function on
	OFF	Pass/Fail function off
Source	CH1	Source signal CH1
	CH2	Source signal CH2
Operate	▶	Start Pass/Fail test
	■	Stop Pass/Fail test
Setup Mask	----	Set up the regulations
More 1/2	----	Display the menu 2/2



Basic Operation

Press **More 1/2** to display the **PASS/FAIL** menu 2/2.



Softkey	Options	Description
Msg Display	ON	Pass/Fail count message on
	OFF	Pass/Fail count message off
Output	PASS	Output on Pass waveforms
	PASS+	Output and alarm on Pass waveforms
	FAIL	Output on Fail waveforms
	FAIL+	Output and alarm on Fail waveforms
Stop on Output	ON	Stop sampling on output
	OFF	Continue sampling on output
	----	Return to the UTILITY menu
More 2/2	----	Display the menu page 1/2

Note: Pass/Fail function is not available when X-Y mode is selected.

Basic Operation

Press **UTILITY** → **Pass/Fail** → **Setup Mask** to display the **MASK** menu 1/2.

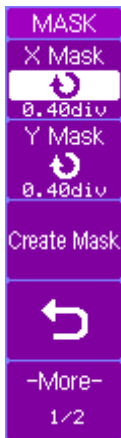

Softkey	Options	Description
X Mask	↻	Set horizontal tolerance
Y Mask	↻	Set vertical tolerance.
Create Mask	----	Create the PASS/FAIL tolerance mask.
↶	----	Return to the PASS/FAIL menu
More 1/2	----	Display the menu 2/2

Basic Operation

Press **More 1/2** to display the **MASK** menu 2/2.

	Softkey	Options	Description
MASK	Internal Storage	----	Store the PASS/FAIL tolerance mask to internal memory.
Internal Storage	External Storage	----	Store the PASS/FAIL tolerance mask to external USB mass storage device.
External Storage		----	Return to the PASS/FAIL menu
-More- 2/2	More 2/2	----	Display the menu page 1/2

Basic Operation

Self-Calibration

If you want to maximize the measurement accuracy, you can perform the self-calibration.

Self-calibration uses the internally generated signals to optimize circuits that affect channel scale, offset and trigger parameters. Disconnect all inputs and allow the oscilloscope to warm up at least 30 minutes before performing this self-calibration.

Press **UTILITY** → **Self-Cal** to display the self-calibration page. Press **AUTO** key to exit the Self-Calibration, press **RUN** key to start the self-calibration.

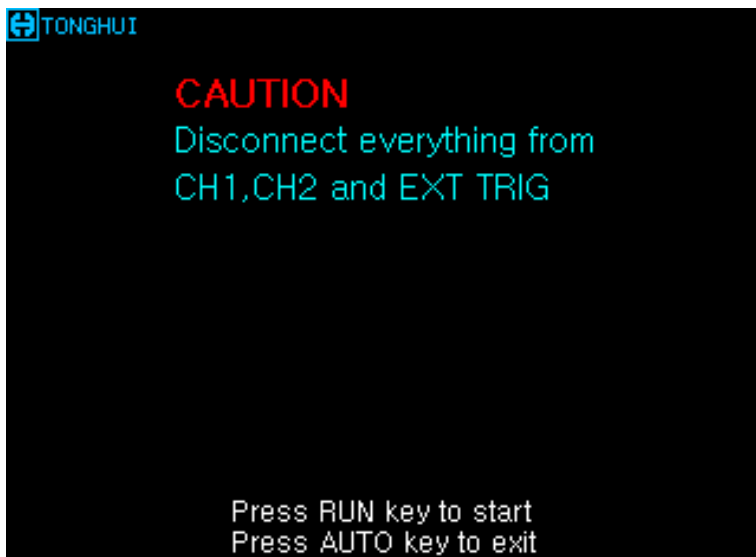

Self Calibration

Basic Operation

Note: Warm up the oscilloscope at least 30 minutes before performing self-calibration.

Basic Operation

MEASURE Menu

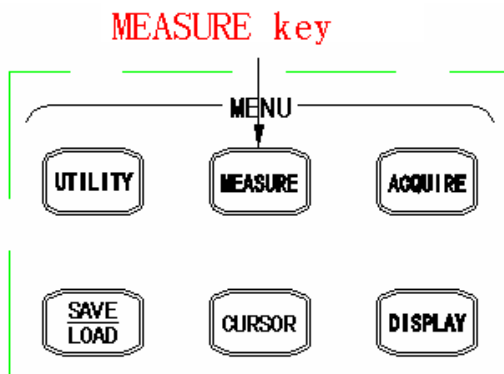

MEASURE Menu key

Basic Operation

Press **MEASURE** menu key to display the **MEASURE** menu.

MEASURE	Softkey	Options	Description
Source	Source	CH1	Measure CH1
CHI		CH2	Measure CH2
Voltage	Voltage	----	Select the Voltage measurement menu.
Time	Time	----	Select the Time measurement menu
Clear	Clear	----	Turn off the current measurement readouts
Measure All	Measure All	ON	Display all measurements
OFF		OFF	Close all measurements

Basic Operation

Voltage Measurements

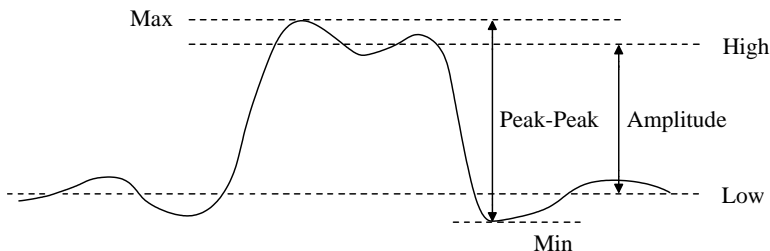

Voltage parameter definitions

Press **MEASURE** → **Voltage** to display the **VOLTAGE** menu page 1/4.



Softkey	Options	Description
Peak-Peak	----	The Peak-Peak value is the difference between maximum and minimum values.
Amplitude	----	The Amplitude value is the difference between High and Low values.
Max	----	Max is the highest value in the waveform display.
Min	----	Min is the lowest value in the waveform display
More 1/4	----	Display menu page 2/4

Basic Operation

Press **More 1/4** softkey to display the **VOLTAGE** menu page 2/4.



Softkey	Options	Description
High	----	High value is the mode (most common value) of the upper part of the waveform.
Low	----	Low value is the mode (most common value) of the lower part of the waveform.
Average	----	Average value is the sum of the samples divided by the number of samples over the entire waveform.
RMS	----	RMS value is the true Root Mean Square voltage over the entire waveform.
More 2/4	----	Display menu page 3/4

Basic Operation

Press **More 2/4** softkey to display the **VOLTAGE** menu page 3/4.



Softkey	Options	Description
Cycle Avg	----	Cycle Avg value is the sum of the samples divided by the number of samples over one period.
Cycle RMS	----	Cycle RMS value is the true Root Mean Square voltage over one period.
Overshoot	----	Overshoot value is distortion that follows a major edge transition expressed as a percentage of amplitude.
Preshoot	----	Preshoot value is distortion that precedes a major edge transition expressed as a percentage of amplitude.
More 3/4	----	Display menu page 4/4

Basic Operation

$$\text{Rising Edge Overshoot} = \frac{\text{Max} - \text{High}}{\text{Amplitude}} \times 100$$

$$\text{Falling Edge Overshoot} = \frac{\text{Low} - \text{Min}}{\text{Amplitude}} \times 100$$

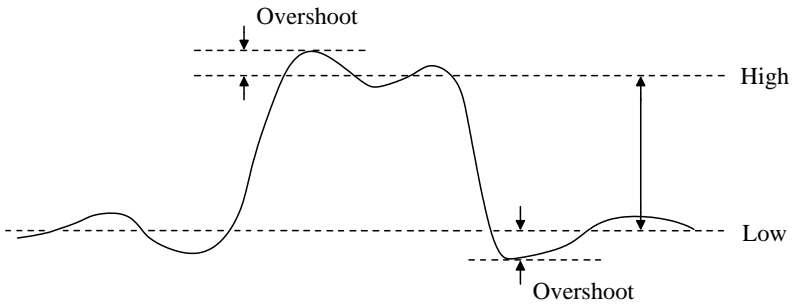

$$\text{Rising Edge Preshoot} = \frac{\text{Low} - \text{Min}}{\text{Amplitude}} \times 100$$

$$\text{Falling Edge Preshoot} = \frac{\text{Max} - \text{High}}{\text{Amplitude}} \times 100$$

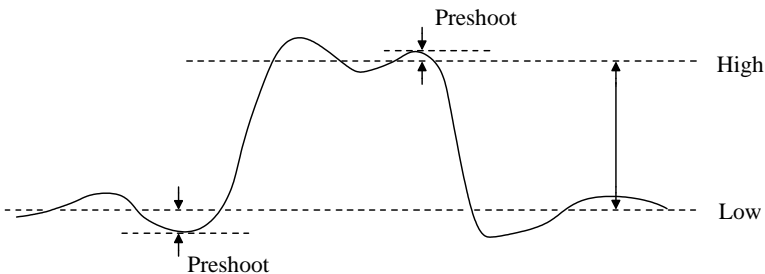

Basic Operation

Press **More 3/4** softkey to display the **VOLTAGE** menu page 4/4.

VOLTAGE	Softkey	Options	Description
		----	Return to the MEASURE menu
	More 4/4	----	Display menu page 1/4





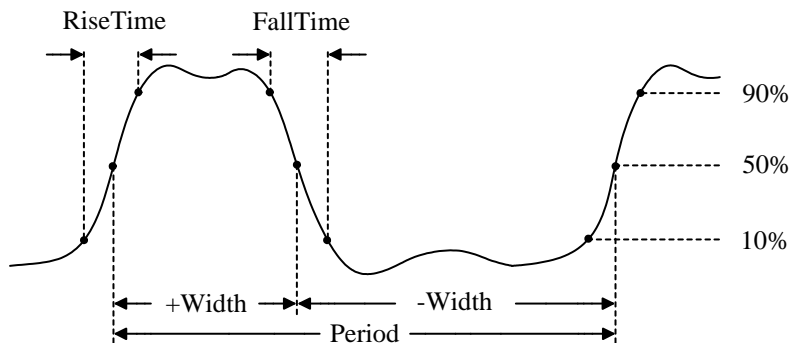

Time Measurements



Time parameter definitions





Basic Operation

Press **MEASURE** → **Time** to display the **TIME** menu page 1/5.

TIME	Softkey	Options	Description
 Frequency	Frequency	----	Frequency is defined as 1/period of the first cycle.
 Period	Period	----	Period is the time period of the first complete waveform cycle.
 Rise Time	Rise Time	----	Rise Time is the time that the first positive-going edge takes to rise from 10% to 90% of its amplitude.
 Fall Time	Fall Time	----	Fall Time is the time that the first negative-going edge takes to fall from 90% to 10% of its amplitude.
-More- 1/5	More 1/5	----	Display menu page 2/5

Basic Operation

Press **More 1/5** softkey to display the **TIME** menu page 2/5.

TIME	Softkey	Options	Description
 + Width	+Width	----	Positive Width is the time between the 50% amplitude points of the first positive pulse.
 - Width	-Width	----	Negative Width is the time between the 50% amplitude points of the first negative pulse.
 + Duty	+Duty	----	Positive Duty is the ratio of the first positive width to its period, expressed as a percentage.
 - Duty	-Duty	----	Negative Duty is the ratio of the first negative width to its period, expressed as a percentage.
-More- 2/5	More 2/5	----	Display menu page 3/5

Basic Operation

Press **More 2/5** softkey to display the **TIME** menu page 3/5.

TIME	Softkey	Options	Description
1 ←→ 2 Delay1f+2f	Delay 1f+2f	----	The time between the 50% amplitude points of the first positive-going edge of each channel.
1 ←→ 2 Delay1r+2r	Delay 1r+2r	----	The time between the 50% amplitude points of the first negative-going edge of each channel.
1 ←→ 2 Delay1f+2r	Delay 1f+2r	----	The time between the first positive-going edge of CH1 and the first negative-going edge of CH2 at each 50% amplitude point.
1 ←→ 2 Delay1r+2f	Delay 1r+2f	----	The time between the first negative-going edge of CH1 and the first positive-going edge of CH2 at each 50% amplitude point.
-More- 3/5	More 3/5	----	Display menu page 4/5

Basic Operation

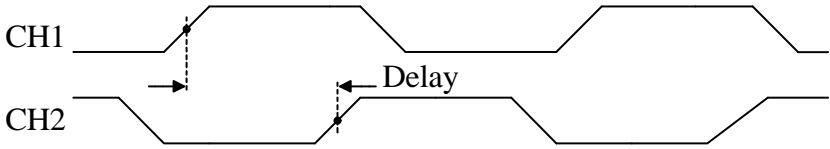

Delay $1f+2f$ definition

Basic Operation

Press **More 3/5** softkey to display the **TIME** menu page 4/5.



Softkey	Options	Description
Phase 1→2	----	Phase 1→2 is the ratio of Delay 1→2 to the period of CH1, expressed in degrees.
Phase 2→1	----	Phase 2→1 is the ratio of Delay 2→1 to the period of CH2, expressed in degrees.
X at Max	----	X at Max is the X axis value (refer to Trigger point) at the first displayed occurrence of the waveform Maximum, starting from the left side of the display.
X at Min	----	X at Min is the X axis value (refer to Trigger point) at the first displayed occurrence of the waveform Minimum, starting from the left side of the display.
More 4/5	----	Display menu page 5/5

Basic Operation

$$\text{Phase } 1 \rightarrow 2 = \frac{\text{CH2 50\% Time} - \text{CH1 50\% Time}}{\text{CH1 Period}} \times 360$$

$$\text{Phase } 2 \rightarrow 1 = \frac{\text{CH1 50\% Time} - \text{CH2 50\% Time}}{\text{CH2 Period}} \times 360$$

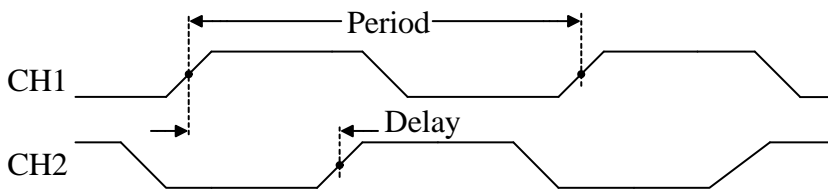

Phase 1→2 definition

Press **More 4/5** softkey to display the **TIME** menu page 5/5.

TIME	Softkey	Options	Description
	↶	----	Return to the MEASURE menu
	More 5/5	----	Display menu page 1/5
↶			
-More- 5/5			

Basic Operation

Automatic Measurement Procedure

Press **MEASURE** → **Measure All** to turn on all Auto Measurements. Up to 20 kinds of measurements of current channel are displayed on the center of the screen.

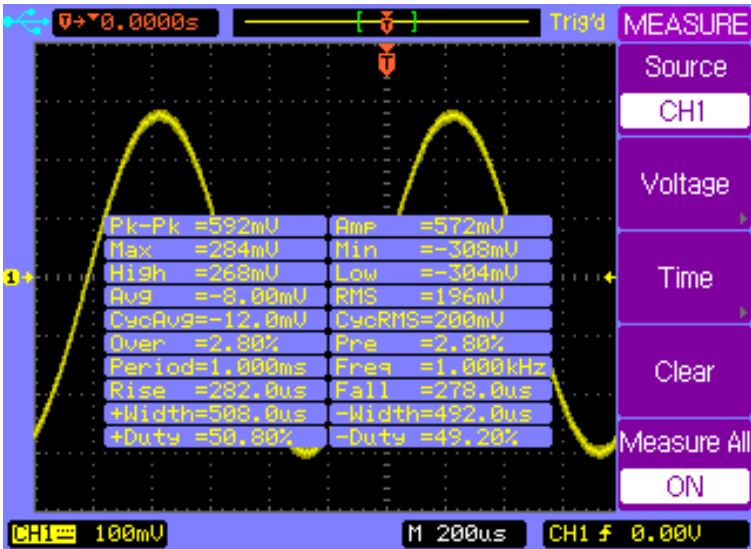

Press **Measure All** again to turn off all Auto Measurements.

Press **MEASURE** → **Voltage** to display the **VOLTAGE** menu or press **MEASURE** → **Time** to display the **TIME** menu.

Press softkey of voltage or time parameters you want to measure.

Basic Operation

The selected parameter will be displayed on the bottom of the display.

Press **Clear** softkey to clear all displayed measurement parameter.

Note: Up to three parameters can be displayed at the same time on the bottom of the display. Press the parameter softkey to add a new parameter when three parameters are already displayed. The first parameter will be pushed out of the display window and the new parameter will be displayed on the bottom right of the display screen.

Note: "*" will be displayed when a parameter can not be measured correctly.***

Basic Operation

SAVE/LOAD Menu

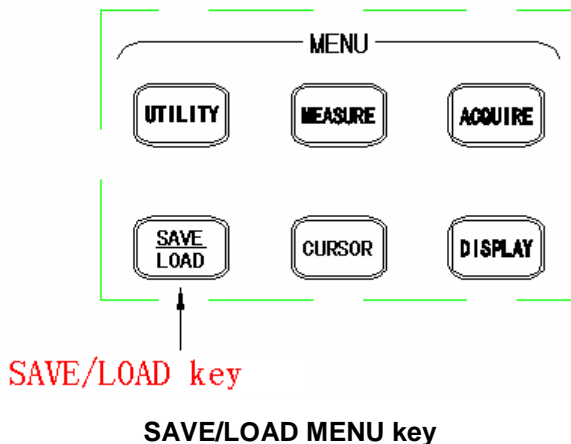

Press **SAVE/LOAD** key to display the **SAVE/LOAD** menu.

SAVE/LOAD	Softkey	Options	Description
Internal Storage	Internal Storage	----	Display the INTERNAL menu.
External Storage	External Storage	----	Display the EXTERNAL menu.
Factory	Factory	----	Set the instrument to the factory default configuration.

Basic Operation

Internal Storage

Press **SAVE/LOAD** → **Internal Storage** → **Storage type** to display the **INTERNAL** menu and select Trace storage type.



Softkey	Options	Description
Storage type	Traces	Trace file format
	Setups	Setup file format
Tracexx	↻	Select a trace file from Trace01 to Trace10.
Save	----	Save the display to current trace file.
Load	----	Load the current trace file.
↻	----	Return to the SAVE/LOAD menu

Basic Operation



Press **SAVE/LOAD** → **Internal Storage** → **Storage type** to display the **INTERNAL** menu and select Setups storage type.

INTERNAL Storage type Setups ↻ Setup01 Save Load ↻	Softkey	Options	Description
	Storage type	Traces	Trace file format
		Setups	Setup file format
	Setupxx	↻	Select a setup file from Setup01 to Setup10.
	Save	----	Save the current configuration to the current setup file.
	Load	----	Load from the current setup file.
	↻	----	Return to the SAVE/LOAD menu

Basic Operation

External Storage



Press **SAVE/LOAD** → **External Storage** to display the **EXTERNAL** menu.

EXTERNAL	Softkey	Options	Description
New	New	----	Create a new file or folder in the external memory.
Rename	Rename	----	Rename the current file or folder.
Load	Load	----	Load the current file.
Delete	Delete	----	Delete the current file or folder.
		----	Return to the SAVE/LOAD menu

Note: The External Storage menu and operations will not be available unless the external USB mass storage device is installed.

Basic Operation

Press **SAVE/LOAD** → **External Storage** → **New** to display the **New** menu.

	Softkey	Options	Description
New	New File	----	Display the New File menu.
New File	New Folder	----	Display the New Folder menu.
New Folder		----	Return to the EXTERNAL menu
			

Basic Operation



Press **SAVE/LOAD** → **External Storage** → **New** → **New File** to display the **New File** menu.

New File	Softkey	Options	Description
Save as	Save as	Setups	Save as setup files
Setups		Traces	Save as trace files
Enter		Waveforms	Save as waveform files
Character		BMP(8bit)	Save as 8-bit BMP files
Delete		BMP(24bit)	Save as 24-bit BMP files
Character		CSV	Save as CSV files
Save	Enter Character	----	Enter the selected character and go to the next character position.
↶	Delete Character	----	Delete the selected character.
	Save	----	Save the new file.
	↶	----	Return to New menu

Note: Maximum length of a file name is 8 characters.
Press Enter Character to select a character position in the file name. Turn the entry knob to select a character. Press Delete Character to delete the current selected character. Press Enter Character to enter the selected character and go to the next character position.

Basic Operation

Press **SAVE/LOAD** → **External Storage** → **New** → **New Folder** to display the **New Folder** menu.

New Folder	Softkey	Options	Description
Enter Character	Enter Character	----	Enter the selected character and go to the next character position.
Delete Character	Delete Character	----	Delete the selected character.
Save	Save	----	Save the new folder.
		----	Return to the New menu



Basic Operation

Press **SAVE/LOAD** → **External Storage** → **Rename** to display the **Rename** menu.

	Softkey	Options	Description
Rename	Enter Character	----	Enter the selected character and go to the next character position.
Enter Character	Delete Character	----	Delete the selected character.
Delete Character	OK	----	Rename the selected file or folder.
OK		----	Return to the EXTERNAL menu

Basic Operation

Press **SAVE/LOAD** → **External Storage** → **Delete** to display the **Delete** menu.

	Softkey	Options	Description
Delete	OK	----	Confirm to delete the selected file or folder.
OK	Cancel	----	Cancel the delete operation.
Cancel		----	Return to the EXTERNAL menu
			

Basic Operation

Software Update

Press **SAVE/LOAD** → **External Storage** to display the **EXTERNAL** menu.

Turn the entry knob to select the correct update file. File TDO3000.UPT is selected as shown in the following figure.

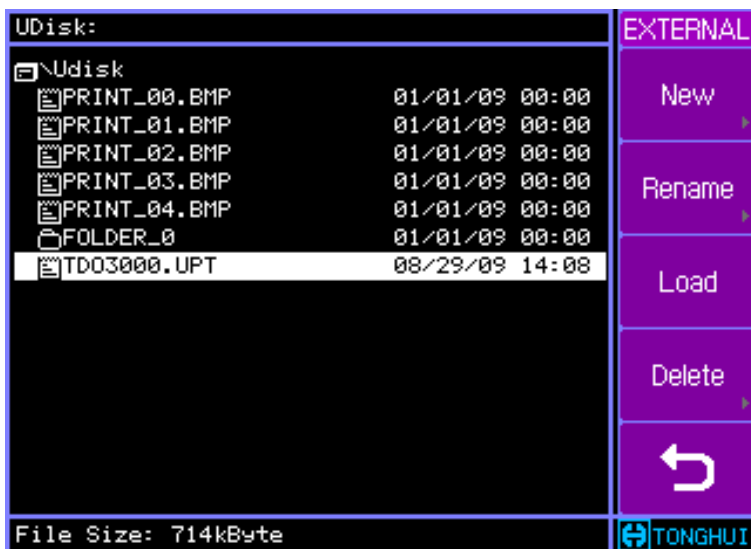

Press **Load** softkey to start the update operation. A Loading and then an updating progress bar will be displayed and indicate the process of the update operation.

Finally, information “**Restart to complete updating**” will be displayed to remind you to restart the instrument.

Basic Operation

If the software update is failed, repeat the above procedures to update again.

Note: The default file extension of the update file is ".upt".

Select the correct update file according to the model of the oscilloscope. Error message "Incompatible file" will be displayed when the model is not match.

Note: The power supply of the oscilloscope can not be turned off during the updating process. If this happens, you will have to return the instrument to factory for service.

Basic Operation

CURSOR Menu

You can measure waveform data using cursors. Cursors are horizontal and vertical markers that indicate X-axis values (usually time) and Y-axis (usually voltage) on a selected waveform source. The position of the cursors can be moved by turning the entry knob.

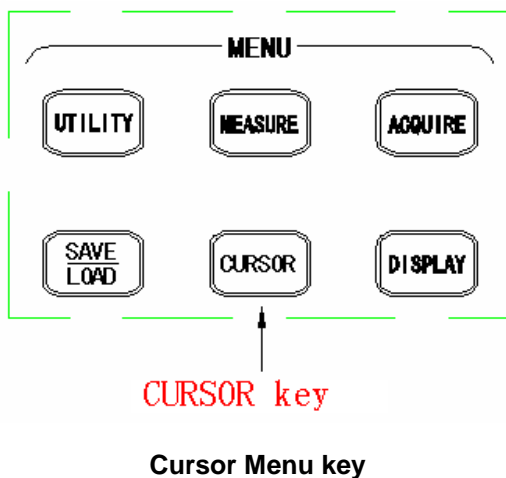

The oscilloscope provides three kinds of cursor measurement modes: **Manual**, **Auto** and **Track**.

Basic Operation

Manual Mode

In the manual mode, you can move the cursors to measure the voltage or time on the select source waveform.

Press **CURSOR** → **Mode** to display the **CURSOR** menu and select the **Manual** mode. Press the **Type** softkey to select **Voltage** measurement.

CURSOR	Softkey	Options	Description
Mode	Mode	Manual	Manual cursor measurement
Manual		Auto	Auto cursor measurement
Source		Track	Track cursor measurement
CH1	Source	CH1	Measure CH1
Type		CH2	Measure CH2
Voltage		MATH	Measure MATH
Y1 -- 1.00U	Type	Voltage	Measure voltage value
Y2 -- -1.00U		Time	Measure time value
ΔY 2.00U	Y1-- Y2--	↻	Press this softkey to active Y1, Y2, or both Y1 and Y2 cursors for adjustment. Current voltage values for Y1 and Y2 are displayed in the softkey or on the top right corner when menu is off.
	ΔY	----	The difference value between Y1 and Y2 cursors.

Basic Operation

Press **CURSOR** → **Mode** to display the **CURSOR** menu and select the **Manual** mode. Press the **Type** softkey to select **Time** measurement.



Softkey	Options	Description
Mode	Manual	Manual cursor measurement
	Auto	Auto cursor measurement
	Track	Track cursor measurement
Source	CH1	Measure CH1
	CH2	Measure CH1
	MATH	Measure MATH
Type	Voltage	Measure voltage value
	Time	Measure time value
X1-- X2--	↻	Press this softkey to select X1, X2, or both X1 and X2 cursors for adjustment. Current time values for X1 and X2 are displayed in the softkey or on the top right corner when menu is off.
ΔX 1/ΔX	----	ΔX is the time difference value between X1 and X2 cursors. 1/ΔX is the frequency between X1 and X2

Basic Operation

TRACK Mode

Two cross hair cursors are displayed on the screen in the track mode. The cross hair cursors track the waveform automatically. You can move the cross hair cursors horizontally by turning the entry knob. The X,Y values of each cross hair cursor are displayed in the softkey area, or on the top right corner when menu is off.

Basic Operation

Press **CURSOR** → **Mode** to display the **CURSOR** menu and select the **Track** mode.

CURSOR	Softkey	Options	Description
Mode	Mode	Manual	Manual cursor measurement
Track		Auto	Auto cursor measurement
Cursor A		Track	Track cursor measurement
Cursor A	Cursor A	CH1	Track CH1 with Cursor A
CH1		CH2	Track CH2 with Cursor A
Cursor B		None	Turn off Cursor A
None	Cursor B	CH1	Track CH1 with Cursor B
Ax-- -6.000uε Ay-- -80.0mV		CH2	Track CH2 with Cursor B
By-- ***** *****		None	Turn off Cursor B
Ax-- Ay--	↻		Press this softkey to select Cursor A for adjustment. Current X, Y axis values for tacking point of Cursor A are displayed in the softkey or on the top right corner when menu is off.
Bx-- By--	↻		Press this softkey to select Cursor B for adjustment. Current X, Y axis values for tacking point of Cursor B are displayed in the softkey or on the top right corner when menu is off.

Basic Operation

AUTO Mode

The Auto mode cursors are displayed only when auto measurement function is enabled. The oscilloscope displays the auto cursors corresponding to the latest auto measurement parameter. No Auto cursors will be displayed when no auto measurement parameter is selected.

Basic Operation

DISPLAY Menu

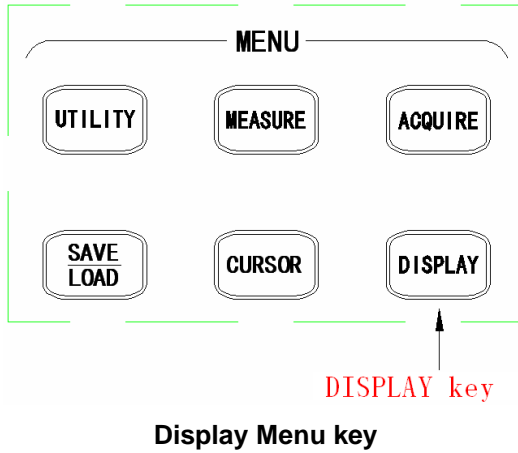









Basic Operation

Press **DISPLAY** menu key to display the **DISPLAY** menu page 1/2.

	Softkey	Options	Description
	Type	Vector	Vector mode fills the space between adjacent sample points in the waveform.
		Dots	Dot mode only displays the sample points
	Persist	ON	The scope updates the waveform without erasing the previous sample points.
		OFF	Turn off the persistence function
	Clear Persistence	----	Press the softkey to erase the previous sample points as well as the loaded trace waveform.
Intensity	↻	Adjust the display intensity of waveforms.	
More 1/2	----	Display menu page 2/2.	

Basic Operation

Press **More 1/2** softkey to display the **DISPLAY** menu page 2/2.

DISPLAY	Softkey	Options	Description
Grid 	Grid		Display both grids and axes.
Brightness 50% 			Turn off the axes.
Color Setup 1			Turn off the grids.
Menu Display 			Turn off both grids and axes.
-More- 2/2	Brightness		Adjust the brightness of the grids.
	Color Setup	----	Select Color scheme
	Menu Display		Adjust the menu hold on time
	More 2/2	----	Display menu page 1/2.

RUN Controls

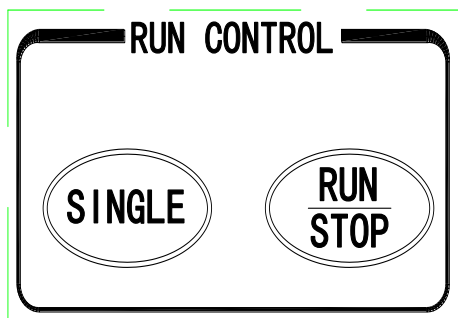

Run controls

Press the **SINGLE** key to execute a single-shot acquisition. The key will illuminate in orange until the oscilloscope is triggered.

Press the **RUN/STOP** key to make the oscilloscope start looking for a trigger. The **RUN/STOP** key will illuminate in green. When the trigger mode is set to Normal mode, the display will not update until a trigger is found. If the trigger mode is set to Auto mode, the oscilloscope looks for a trigger, and if no trigger is found, it will be triggered automatically and the waveform of input signals will be showed immediately.

Press the **RUN/STOP** key again to stop acquiring data and the **RUN/STOP** key will illuminate in red. Now you can pan across and zoom in on the acquired waveform.

Basic Operation

Short-Cut Controls

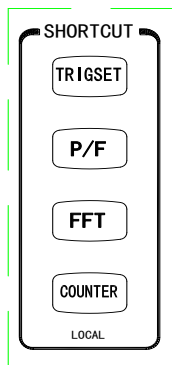

These four short-cut keys provide alternate quick accesses to some most frequently used functions or menus.

Press **TRIGSET** short-cut key to display the trigger **SETUP** menu directly.

Press **P/F** short-cut key to display the **PASS/FAIL** menu directly.

Press **FFT** short-cut key to display the **FFT** menu directly.

Press **COUNTER** short-cut key to turn on/off the hardware frequency counter function when the oscilloscope is not in remote status. Otherwise when the oscilloscope is in the remote status, press this same key to resume the front panel operation.

F/A WG Controls

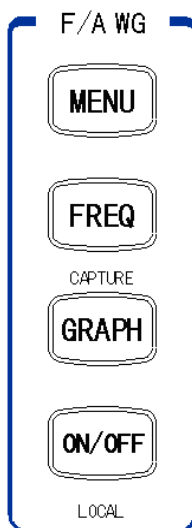

F/A WG **MENU** key

Press the **MENU** key from the front panel to show the F/A WG menu, then you can select various the standard waveforms as well as the modulated waveforms. The **menu** key is illuminated when F/A WG menu is displayed.

FREQ key

Press the **FREQ** shortcut key to go directly to the frequency parameter of the currently active waveform function. You can also access the frequency parameter through the F/A WG menu. When the frequency parameter is selected, the **FREQ** key is illuminated.

Basic Operation

GRAPH (CAPTURE) key

When User ARB waveform is not selected, press the **GRAPH** key to enable the Graph display. When Graph display is on, the **GRAPH** key is illuminated. In the Graph display, you can view a graphical representation of the current waveform. Press the **GRAPH** key again to turn off the Graph display and turn off the **GRAPH** key at the same time.

When User ARB waveform is selected, the **GRAPH** key serves as a **CAPTURE** key used to capture the current displayed waveform.

ON/OFF key

Press **ON/OFF** key to enable or disable the F/A WG signal output. By default, the output is disabled at power on. When enabled, the **ON/OFF** key is illuminated.

The **ON/OFF** key also serves as a **LOCAL** key to restore front-panel control after remote interface operations.

Basic Operation

Press the F/A WG **MENU** key and press **Output Type** softkey to select Sine waveform. **SINE** menu will be displayed.

SINE	Output Type	10.00000 kHz	600.00 mVPP Ampl	0.000 mVdc Offset	
SINE					
Output Type					
Sine					
Freq					
Ampl					
Offset					
Output Type		Press Output Type softkey to select various standard waveforms as well as the modulated waveforms and output a waveform when output is enabled. Current waveform menu will be displayed.			
Freq		Press Freq softkey to select the frequency parameter. Use the left or right keys below the knob to select a position and rotate the knob to change a digit. When a unit is selected, rotating the knob will change the value by ten-folds.			
Ampl		Press Ampl softkey to select and change the amplitude parameter.			
Offset		Press Offset softkey to select and change the offset parameter.			

Basic Operation

Press the F/A WG **MENU** key and press **Output Type** softkey to select Square waveform, **SQUARE** menu will be displayed.

SQUARE	Softkey	Description
Output Type Square 10.000000 kHz Freq 600.00 mVpp Ampl 0.000 mVdc Offset	Output Type	Press Output Type softkey to select various standard waveforms as well as the modulated waveforms and output a waveform when output is enabled. Current waveform menu will be displayed.
	Freq	Press Freq softkey to select the frequency parameter. Use the left or right keys below the knob to select a position and rotate the knob to change a digit. When a unit is selected, rotating the knob will change the value by ten-folds.
	Ampl	Press Ampl softkey to select and change the amplitude parameter.
	Offset	Press Offset softkey to select and change the offset parameter.

Basic Operation

Press the F/A WG **MENU** key and press **Output Type** softkey to select Pulse waveform, **PULSE** menu will be displayed.

Softkey	Description
Output Type	Press Output Type softkey to select various standard waveforms as well as the modulated waveforms and output a waveform when output is enabled. Current waveform menu will be displayed.
Freq	Press Freq softkey to select the frequency parameter. Use the left or right keys below the knob to select a position and rotate the knob to change a digit. When a unit is selected, rotating the knob will change the value by ten-folds.
Ampl	Press Ampl softkey to select and change the amplitude parameter.
Offset	Press Offset softkey to select and change the offset parameter.
Width/ Duty	Press Width/Duty softkey to select and change the pulse width/duty.

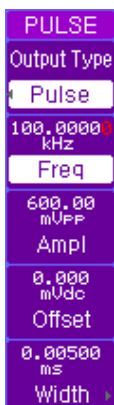

Basic Operation

Press the F/A WG **MENU** key and press **Output Type** softkey to select Built-in ARB waveform, **ARB** menu will be displayed.

ARB	Softkey	Description
Output Type	Output Type	Press Output Type softkey to select various standard waveforms as well as the modulated waveforms and output a waveform when output is enabled. Current waveform menu will be displayed.
Built-in ARB		
Waveform	Waveform	Press Waveform softkey to select a built-in arbitrary waveform.
Sine		
1.00000 kHz	Freq	Press Freq softkey to select the frequency parameter. Use the left or right keys below the knob to select a position and rotate the knob to change a digit. When a unit is selected, rotating the knob will change the value by ten-folds.
Freq		
600.00 mVpp		
Ampl		
0.000 mVdc	Ampl	Press Ampl softkey to select and change the amplitude parameter.
Offset		
Offset	Offset	Press Offset softkey to select and change the offset parameter.

Basic Operation

Press the F/A WG **MENU** key and press **Output Type** softkey to select User ARB waveform, **ARB** menu page 1/2 will be displayed.

ARB	Softkey	Description
Output Type User ARB 1.00000 kHz Freq 600.00 mVpp Ampl 0.000 mVdc Offset -More- 1/2	Output Type	Press Output Type softkey to select various standard waveforms as well as the modulated waveforms and output a waveform when output is enabled. Current waveform menu will be displayed.
	Freq	Press Freq softkey to select the frequency parameter. Use the left or right keys below the knob to select a position and rotate the knob to change a digit. When a unit is selected, rotating the knob will change the value by ten-folds.
	Ampl	Press Ampl softkey to select and change the amplitude parameter.
	Offset	Press Offset softkey to select and change the offset parameter.
	More 1/2	Select page 2/2

Basic Operation

Press **More 1/2** softkey to display the **ARB** menu page 2/2.

ARB	Softkey	Options	Description
Interpolation	ON	ON	With interpolation enabled, the waveform editor makes a straight-line connection between points.
Capture/ Storage			With interpolation disabled, the waveform editor maintains a constant voltage level between points and creates a step waveform
-More- 2/2	Interpolation	OFF	
	Capture/ Storage	----	Select the ARB DATA menu
	More 2/2	----	Select page 1/2

Basic Operation

Press **Capture/Storage** softkey to display the **ARB DATA** menu.

ARB DATA	Softkey	Options	Description
Source	Source	CH1	Source signal CH1
CH1		CH2	Source signal CH2
Data Type		MATH	Source signal MATH
Screen Data	Date Type	Screen Data	Currently displayed data on the screen.
Internal Storage		Period Date	One period of currently displayed data on the screen. If the waveform is non-periodic, then the whole screen data is regarded as one period.
External Storage	Internal Storage	----	Enter the INTERNAL menu for arbitrary waveform save/load operation.
↶	External Storage	----	For External Storage, refer to previous SAVE/LOAD menu operation.
↶	↶	----	Return to ARB menu.

Basic Operation

Press **Internal Storage** softkey to display the **INTERNAL** menu.

INTERNAL	Softkey	Options	Description
Storage Pos	Storage Pos	Volatile	File saved to volatile cannot be retrieved after power off.
User01		User01- User10	Files saved to User01 to User10 can be retrieved after power off.
Save	Save	----	Save the displayed screen waveform to the currently selected position.
Load	Load	----	Load the waveform from the currently selected position.
Copy	Copy	----	Copy the waveform from Volatile to the currently selected position.
↶	↶	----	Return to ARB DATA menu.

Basic Operation

Press the F/A WG **MENU** key and press **Output Type** softkey to select AM modulation, **AM** menu page 1/2 will be displayed.

AM	Softkey	Options	Description
Output Type AM	Output Type	----	Press Output Type softkey to select various standard waveforms as well as the modulated waveforms and output a waveform when output is enabled. Current waveform menu will be displayed.
CarrierShape Sine		Sine	Select sine waveform as the carrier waveform.
Carrier Freq 10.00000 kHz		Square	Select square waveform as the carrier waveform.
Carrier Ampl 600.00 mVPP		----	Select and specify the carrier frequency.
-More- 1/2		----	Select and specify the carrier amplitude.
		More 1/2	----

Basic Operation

Press **More 1/2** softkey to display the **AM** menu page 2/2.

AM	Softkey	Description
Mod Shape	Mod Shape	Select a waveform as the modulating waveform.
100.000 Hz	Mod Freq	Select and specify the modulating frequency.
AM Depth	AM Depth	Select and specify the modulating depth.
Offset	Offset	Select and specify the offset voltage
-More- 2/2	More 2/2	Select page 1/2

Note: *The modulation depth is expressed as a percentage and represents the extent of the amplitude variation. At 0% depth, the output amplitude is half of the selected value. At 100% depth, the output amplitude equals the selected value.*

Basic Operation

Press the F/A WG **MENU** key and press **Output Type** softkey to select FM modulation, **FM** menu page 1/2 will be displayed.

FM	Softkey	Options	Description
Output Type FM	Output Type	----	Press Output Type softkey to select various standard waveforms as well as the modulated waveforms and output a waveform when output is enabled. Current waveform menu will be displayed.
CarrierShape Sine		Sine	Select sine waveform as the carrier waveform.
Carrier Freq 10.00000 kHz		Square	Select square waveform as the carrier waveform.
Carrier Ampl 600.00 mVPP		----	Select and specify the carrier frequency.
-More- 1/2		----	Select and specify the carrier amplitude.
		More 1/2	----

Basic Operation

Press **More 1/2** softkey to display the **FM** menu page 2/2.

FM	Softkey	Description
Mod Shape	Mod Shape	Select a waveform as the modulating waveform shape.
100.000 Hz	Mod Freq	Select and specify the modulating frequency.
Mod Freq	Mod Freq	Select and specify the modulating frequency.
50.1%	FM Dev	Select and specify the frequency deviation.
FM Dev	FM Dev	Select and specify the frequency deviation.
0.000 mVdc	Offset	Select and specify the offset voltage.
Offset	Offset	Select and specify the offset voltage.
-More- 2/2	More 2/2	Select page 1/2

Note: *The frequency deviation is expressed as a percentage and represents the peak variation in frequency of the modulated waveform from the carrier frequency.*

Basic Operation

Press the F/A WG **MENU** key and press **Output Type** softkey to select PWM modulation, **PWM** menu page 1/2 will be displayed.

PWM	Softkey	Description
Output Type PWM	Output Type	Press Output Type softkey to select various standard waveforms as well as the modulated waveforms and output a waveform when output is enabled. Current waveform menu will be displayed.
10.00000 kHz Carrier Freq	Carrier Freq	Select and specify the carrier frequency.
600.00 mVPP Carrier Ampl	Carrier Ampl	Select and specify the carrier amplitude.
0.00000 ms Width	Width/ Duty	Press Width/Duty softkey to select and change the pulse width/duty.
-More- 1/2	More 1/2	Select page 2/2

Basic Operation

Press **More 1/2** softkey to display the **PWM** menu page 2/2.

PWM	Softkey	Description
Mod Shape	Sine	Mod Shape
00.000 Hz	Mod Freq	Mod Freq
50%	Width Dev	Width Dev
0.000 mVdc	Offset	Offset
-More- 2/2	More 2/2	Select page 1/2

Note: *The width deviation is expressed as a percentage and represents the maximum variation in width (in seconds) in the modulated waveform from the width of the original pulse waveform.*

Basic Operation

Press the F/A WG **MENU** key and press **Output Type** softkey to select DCOM modulation, **DCOM** menu page 1/2 will be displayed.

DCOM	Softkey	Options	Description
Output Type	Output Type	----	Press Output Type softkey to select various standard waveforms as well as the modulated waveforms and output a waveform when output is enabled. Current waveform menu will be displayed.
DCOM		Sine	Select sine waveform as the carrier waveform.
CarrierShape	Carrier Shape	Square	Select square waveform as the carrier waveform.
Sine		----	Select and specify the carrier frequency.
10.00000 kHz	Carrier Freq	----	Select and specify the carrier amplitude.
Carrier Freq		----	Select page 2/2
600.00 mVPP	Carrier Ampl	----	
Carrier Ampl		----	
-More-	More 1/2	----	
1/2		----	

Basic Operation

Press **More 1/2** softkey to display the **DCOM** menu page 2/2.

DCOM	Softkey	Description
Mod Shape Sine	Mod Shape	Select a waveform as the modulating waveform shape.
00.000 Hz Mod Freq	Mod Freq	Select and specify the modulating frequency.
	More 2/2	Select page 1/2
-More- 2/2		

Note: *The DC Offset Modulation adds the carrier waveform with the modulating waveform to output a modulated waveform.*

Basic Operation

Press the F/A WG **MENU** key and press **Output Type** softkey to select SWEEP function, **SWEEP** menu page 1/2 will be displayed.

SWEEP	Softkey	Options	Description
Output Type	Output Type	----	Press Output Type softkey to select various standard waveforms as well as the modulated waveforms and output a waveform when output is enabled. Current waveform menu will be displayed.
Sweep			
Waveform			
Sine		Sine	Select sine waveform as the sweep waveform.
10.00000 kHz		Square	Select square waveform as the sweep waveform.
Start Freq		----	Select and specify the start frequency.
1.000000 MHz			
Stop Freq	----	Select and specify the stop frequency.	
-More- 1/2	More 1/2	----	Select page 2/2

Basic Operation

Press **More 1/2** softkey to display the **SWEEP** menu page 2/2.

SWEEP	Softkey	Options	Description
Sweep mode Up	Sweep Mode	Up	Sweep from start frequency to stop frequency.
1.00 s Sweep Time		Down	Sweep from stop frequency to start frequency.
600.00 mVpp Sweep Ampl		Up-Down	Sweep up and down between start and stop frequencies.
0.000 mVdc Offset	Sweep Time	----	Select and specify the sweeping time from start to stop frequency.
-More- 2/2	Sweep Ampl	----	Select and specify the waveform amplitude.
	Offset	----	Select and specify the offset voltage.
	More 2/2	----	Select page 1/2

Note: The sweep time specifies the number of seconds required to sweep from the start frequency to the stop frequency. The number of discrete frequency points in the sweep is automatically calculated according to the sweep time you select.

Basic Operation

Press the F/A WG **MENU** key and press **Output Type** softkey to select BURST function, **BURST** menu page 1/2 will be displayed.

BURST	Softkey	Description
Output Type	Output Type	Press Output Type softkey to select various standard waveforms as well as the modulated waveforms and output a waveform when output is enabled. Current waveform menu will be displayed.
Burst		Select a waveform as the burst waveform.
Waveform		Select and specify the waveform frequency.
Sine		Select and specify the waveform amplitude.
1.00000 kHz		More 1/2
600.00 mVPP Ampl		
-More- 1/2		

Basic Operation

Press **More 1/2** softkey to display the **BURST** menu page 2/2.

BURST	Softkey	Description
3 cyc Cycles	Cycles	Select and specify the number of burst count.
300,000 Hz Burst Freq	Burst Freq	Select and specify the burst frequency
0.000 mVdc Offset	Offset	Select and specify the offset voltage.
-More- 2/2	More 2/2	Select page 1/2

Note: *The burst count defines the number of cycles to be output per burst.*

Note: *The burst frequency defines the frequency of consecutive bursts which is different from the “waveform frequency”.*

Basic Operation

Press the F/A WG **MENU** key and press **Output Type** softkey to select Keying modulation, **KEYING** menu page 1/2 will be displayed.

KEYING	Softkey	Options	Description
Output Type	Output Type	----	Press Output Type softkey to select various standard waveforms as well as the modulated waveforms and output a waveform when output is enabled. Current waveform menu will be displayed.
Keying			
Keying Type			
FSK			
10.00000 kHz			
Carrier Freq			
600.00 mVPP			
Carrier Ampl			
-More- 1/2			
	Keying Type	FSK	Select Frequency Shift Keying modulation
		PSK	Select Phase Shift Keying modulation.
	Carrier Freq	----	Select and specify the carrier waveform frequency.
	Carrier Ampl	----	Select and specify the carrier waveform amplitude.
	More 1/2	----	Select page 2/2

Basic Operation

Press **More 1/2** softkey to display the **KEYING** menu page 2/2.

KEYING	Softkey	Description
100.0000 Hz Hop Freq	Hop Freq/ Hop Phase	Specify the hop frequency in FSK mode, or specify the hop phase in PSK mode.
10ms Interval	Interval	Select and specify the time interval between two frequency shifts.
0.000 mVdc Offset	Offset	Select and specify the offset voltage.
-More- 2/2	More 2/2	Select page 1/2

3. Application Examples

This section presents 7 typical application examples. These simplified examples highlight the features of the oscilloscope and give you ideas of how to solve your own test problems.

Make Simple Measurements

You need to measure the amplitude and frequency of an unknown signal on CH1.

Perform following steps to quickly display the signal.

- Connect the channel 1 probe to the unknown signal.
- Press the **AUTO** key.

The oscilloscope automatically sets vertical, horizontal, and trigger controls. You can adjust any of these controls manually if you need to optimize the display of the waveform.

When you are using both CH1 and CH2 channels, the Autoset function sets the vertical controls for each channel and uses the CH1 channel to set the horizontal and trigger controls.

The oscilloscope can take automatic measurements of the displayed signals. Perform following steps to measure signal amplitude and frequency.



Application Examples

- Press the **MEASURE** key to display the **MEASURE** menu.
- Press the **Voltage** softkey to display the **VOLTAGE** menu.
- Press the **Amplitude** softkey to measure the Amplitude. The amplitude value will be displayed at the bottom of the screen.
- Press **MEASURE** key again to display the **MEASURE** menu.
- Press **Time** softkey to display the **TIME** menu.
- Press the **Frequency** softkey to measure the frequency. The frequency value will be displayed at the bottom of the screen to the right of the voltage value.

Application Examples

Capture a Single-Shot Signal

Digital Storage Oscilloscope can easily be used to capture the single-shot or unrepeatable signal. Perform following steps to capture a single-shot signal.

- Connect the channel 1 probe to the unknown signal.
- Press the trigger **MENU** key to display the **TRIGGER** menu.
- Press the **Source** softkey to select CH1.
- Press the **Mode** softkey to select the Auto trigger mode.
- Adjust the vertical and horizontal controls to observe the the signal roughly. And find out the right Trigger Type and Trigger mode.
- Press the **Type** softkey from the **TRIGGER** menu page to select Pulse trigger type.
- Press **More 1/2** sofkey to display the **TRIGGER** menu page 2/2.
- Press **Mode** softkey to select Normal Trigger mode.
- Press **More 2/2** sofkey to display the **TRIGGER** menu page 1/2.
- Press **Pulse Mode** softkey to select  (positive less than).
- Rotate the entry knob () to set up the pulse width.
- Press the **SINGLE** key to start the acquisition system and search for the trigger condition. The **SINGLE** key is illuminated in orange.

Application Examples

- When trigger condition is met, the captured waveform is displayed, the **SINGLE** key is extinguished and the **RUN/STOP** key is illuminated in red.

Application Examples

Reduce the Random Noise on a Signal

If the test signal is noisy, you can set up the oscilloscope to reduce the noise on the displayed waveform. First, you stabilize the displayed waveform by removing the noise from the trigger path. Second, you reduce the noise on the displayed waveform.

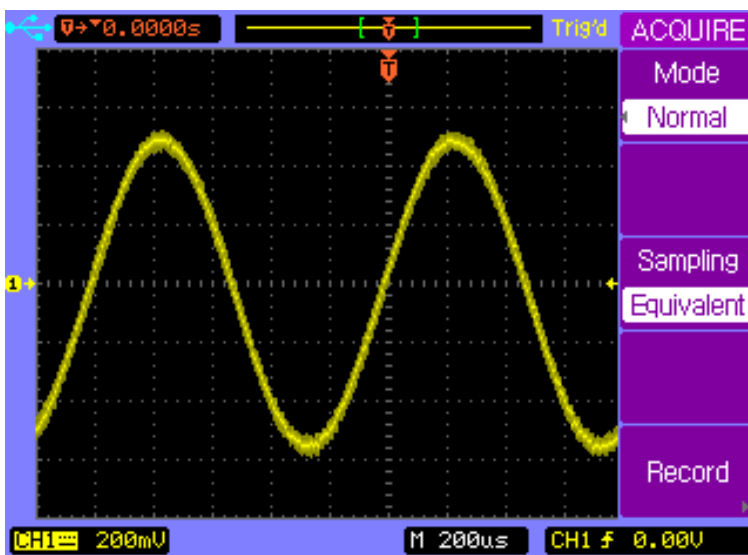

- Connect a signal to the oscilloscope. Press **AUTO** key to display the signal quickly.
- Press the Trigger **MENU** key to display the **TRIGGER** menu.
- Press **Type** softkey to select **Edge** trigger type.

Application Examples

- Press **Trigger Setup** softkey to display the trigger **SETUP** menu
- Press **Coupling** softkey to select **HF Reject** or **LF Reject** coupling mode to reduce the noise from the trigger channel.
- Press the **ACQUIRE** key to display the **ACQUIRE** menu.
- Press the **Mode** softkey to select **Average** mode.
- Rotate the entry knob (↻) to set the number of averages that best eliminates the noise from the displayed waveform.

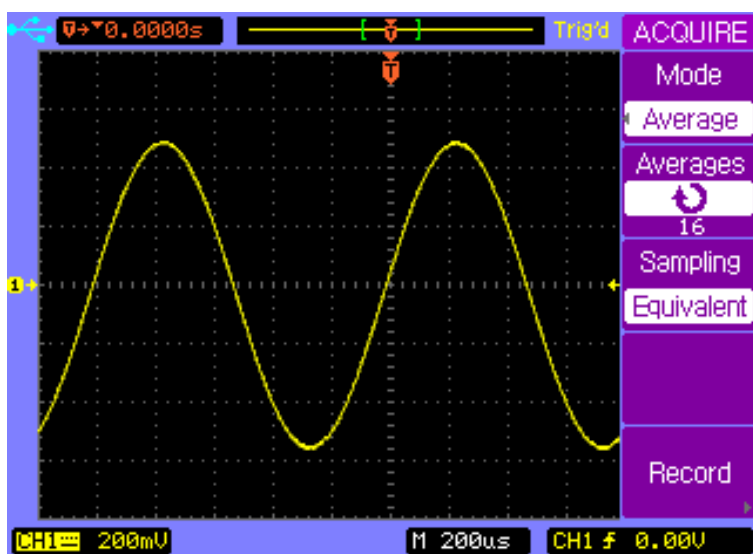

Application Examples

Trigger on a Video Signal

Video trigger can be used to capture the standard video signals. The trigger circuit detects the vertical and horizontal interval of the waveform and produces triggers based on the Video trigger setting you have selected.

Trigger on Odd or Even Fields of the Video Signal

- Press the Trigger **MENU** key to display the **TRIGGER** menu.
- Press the **Type** softkey to select the **Video** trigger mode.
- Press **Source** softkey to select **CH1**.
- Press **Polarity** softkey to select negative polarity $\overline{\square}$.
- Press **Sync** softkey to select **Odd Field** or **Even Field**.

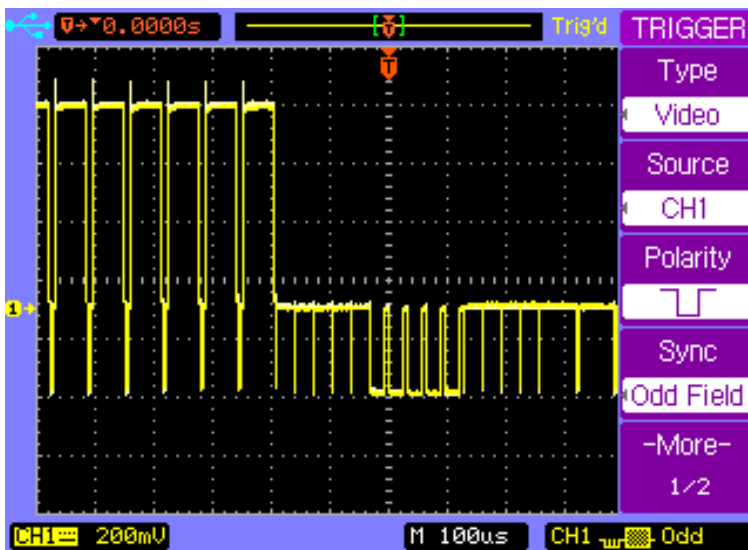

Application Examples

Trigger on a Specific Line or All Lines of the Video Signal

- Press the Trigger **MENU** key to display the **TRIGGER** menu.
- Press the **Type** softkey to select the **Video** trigger mode.
- Press **Source** softkey to select **CH1**.
- Press **Polarity** softkey to select negative polarity $\overline{\square}$.
- Press **Sync** softkey to select **Line #** or **All Lines**.

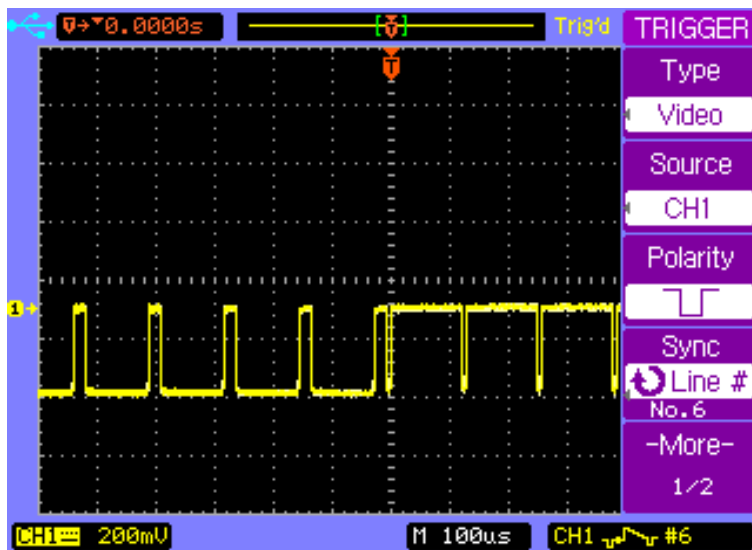

Application Examples

PASS/FAIL Measurement

The oscilloscope measures and compares the input signal with predefined Pass/Fail thresholds. If the input signal is within the thresholds, PASS signal will be outputted. If the input signal exceeds the thresholds, FAIL signal will be outputted.

Perform following steps to make a PASS/FAIL measurement.

- Press **UTILITY** key to display the **UTILITY** menu page 1/2.
- Press **More 1/2** softkey to display the **UTILITY** menu page 2/2/
- Press **Pass/Fail** softkey to display the **PASS/FAIL** menu.
- Press **Enable Test** softkey to turn on the **PASS/FAIL** measurement.
- Press **Setup Mask** softkey to display the **MASK** menu.
- Press **X Mask** softkey and then rotate the entry knob to setup the horizontal threshold.
- Press **Y Mask** softkey and then rotate the entry knob to setup the vertical threshold.
- Press **Creat Mask** softkey to update the thresholds.
- Press **↶** softkey to return to the **PASS/FAIL** menu.
- Press **More 1/2** softkey to display the **PASS/FAIL** menu page 2/2.

Application Examples

- Press **Msg Display** softkey to display the Pass/Fail measurement results on the top left corner of the screen.
- Press the **Output** softkey to set how to output the measurement results.
- Press **More 2/2** to display the **PASS/FAIL** menu page 1/2.
- Press the **Operate** softkey to start PASS/FAIL measurement.

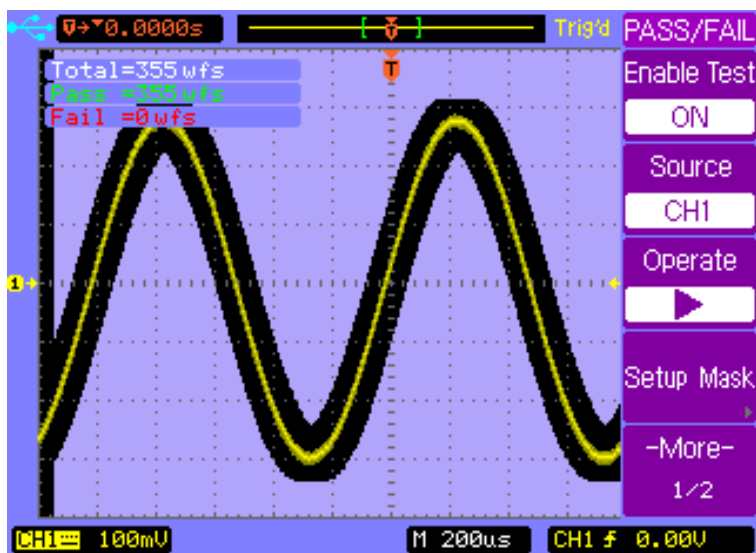

Application Examples

Waveform Recorder

Waveform recorder lets you record waveforms, playback waveforms and save the waveforms.

Perform the following steps to record waveforms.

- Press the **ACQUIRE** key to display the **ACQUIRE** menu.
- Press the **RECORD** softkey to display the **RECORD** menu.
- Press the **Mode** softkey to select **Record** mode.
- Press the **Source** softkey to select the source channel **CH1**.
- Press the **Operate** key to start recording, total recorded frame count is displayed on the top left screen. Press the **Operate** key again to stop recording.

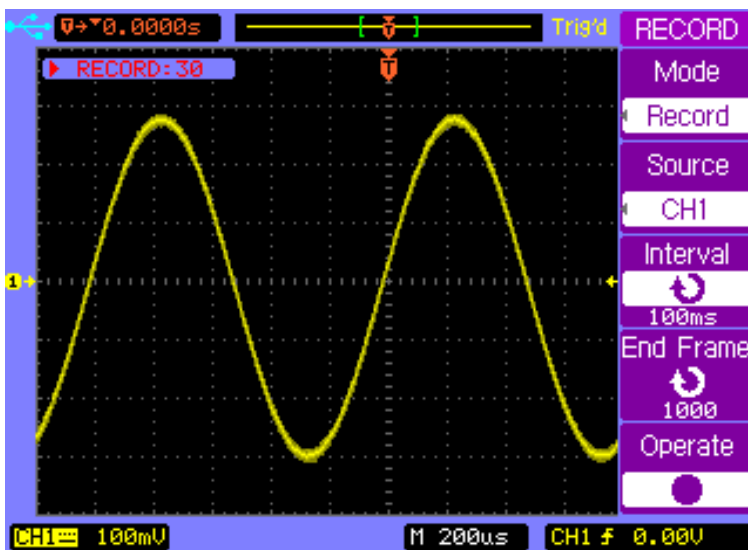

Application Examples

Perform the following steps to playback the waveforms.

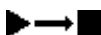
- Press the **ACQUIRE** key to display the **ACQUIRE** menu.
- Press the **RECORD** softkey to display the **RECORD** menu.
- Press the **Mode** softkey to select **Play back** mode.
- Press **Play Mode** softkey to select  or  mode.
- Press the **More 1/2** softkey to display the **RECORD** menu page 2/2.
- Press **Start Frame** softkey and turn the entry knob to set the start frame.
- Press **End Frame** softkey and turn the entry knob to set the end frame.
- Press **Interval** softkey and turn the entry knob to set the interval time.
- Press the **More 2/2** softkey to display the **RECORD** menu page 1/2.
- Press **Operate** softkey to playback the waveform.

Application Examples

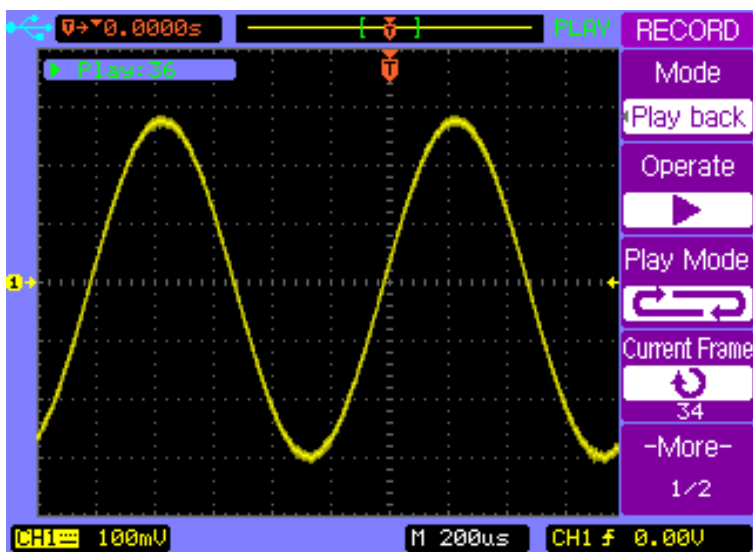

Application Examples

Perform the following steps to save the waveform recorded.

- Press the **ACQUIRE** key to display the **ACQUIRE** menu.
- Press the **RECORD** softkey to display the **RECORD** menu page 1/2.
- Press the **Mode** softkey to select **Save/Recall** mode.
- Press **Start Frame** softkey and turn the entry knob to set the start frame.
- Press **End Frame** softkey and turn the entry knob to set the end frame.
- Press the **Internal Storage** softkey to Save or Load the recorded waveform from the internal memory.



Application Examples

Cursor Measurements

You can use the cursors to quickly make time and voltage measurements on a waveform. You can use the cursors to measure the amplitude and frequency of a FFT waveform. You can also use the cursors to measure the phase difference between two signals with the same frequency when X-Y horizontal mode is selected.

Measure the time and voltage on normal waveform

Perform the following steps to take time and frequency measurements.

- Press the **CURSOR** key to display the **CURSOR** menu.
- Press **Mode** softkey to select the **Manual** mode.
- Press **Type** softkey to select the **Time** type.
- Press **X1--/X2** softkey or press the entry knob to select X1 cursor.
- Rotate the entry knob  to move the X1 cursor.
- Press **X1--/X2** softkey or press the entry knob to select X2 cursor.
- Rotate the entry knob  to move the X2 cursor.
- ΔX and $1/\Delta X$ are displayed in the softkey area. ΔX is the time difference between X1 and X2; $1/\Delta X$ is the frequency between X1 and X2.

Application Examples

Perform the following steps to take voltage measurement.

- Press the **CURSOR** key to display the **CUROSR** menu.
- Press **Mode** softkey to select the **Manual** mode.
- Press **Type** softkey to select the **Voltage** type.
- Press **↻Y1--/↻Y2** softkey or press the entry knob to select Y1 cursor.
- Rotate the entry knob ↻ to move the Y1 cursor.
- Press **↻Y1--/↻Y2** softkey or press the entry knob to select Y2 cursor.
- Rotate the entry knob ↻ to move the Y2 cursor.
- ΔY displayed in the softkey area is the voltage difference between Y1 and Y2.

Application Examples

Measure the frequency and amplitude on FFT waveform

Perform the following steps to take frequency measurement.

- Press the **MATH** key to display the **Math** menu.
- Press the **Operate** softkey to select **FFT** and display the **FFT** menu.
- Press the **CURSOR** key to display the **CUROSR** menu.
- Press **Mode** softkey to select the **Manual** mode.
- Press **Source** softkey to select **FFT**.
- Press **Type** softkey to select the **Time** type.
- Press **↶X1--/↷X2** softkey or press the entry knob to select X1 cursor.
- Rotate the entry knob ↶ to move the X1 cursor.
- Press **↷X1--/↶X2** softkey or press the entry knob to select X2 cursor.
- Rotate the entry knob ↷ to move the X2 cursor.
- ΔX displayed in the softkey area is the frequency difference between X1 and X2. $1/\Delta X$ is the time difference between X1 and X2.

Perform the following steps to take voltage measurement.

- Press the **MATH** key to display the **Math** menu.
- Press the **Operate** softkey to select **FFT** and display the **FFT** menu.
- Press the **CURSOR** key to display the **CUROSR** menu.
- Press **Mode** softkey to select the **Manual** mode.

Application Examples

- Press **Source** softkey to select **FFT**.
- Press **Type** softkey to select the **Voltage** type.
- Press **↻Y1--/↻Y2**—softkey or press the entry knob to select Y1 cursor.
- Rotate the entry knob ↻ to move the Y1 cursor.
- Press **↻Y1--/↻Y2**—softkey or press the entry knob to select Y2 cursor.
- Rotate the entry knob ↻ to move the Y2 cursor.
- ΔY displayed in the softkey area is the voltage difference between Y1 and Y2.

Application Examples

Measure the Phase Difference Between Two Signals of the Same Frequency under X-Y Display Mode.

- Connect a sine wave signal to CH1 and a sine wave signal of the same frequency but out of phase to CH2.
- Press horizontal **MENU** key to display the **Horizontal** menu.
- Press **X-Y** softkey to select **X-Y** display mode
- Center the signal on the display with the vertical control knob of each channel.
- Use the vertical scale control knob of each channel to expand the signal for convenient view.
- Press the **CURSOR** key to display the **CURSOR** menu.
- Press **Mode** softkey to select the **Manual** mode.
- Press **Source** softkey to select **CH2**.
- Press **Type** softkey to select the **Voltage** type.
- Press **Y1--/Y2--** softkey or press the entry knob to select Y1 cursor.
- Rotate the entry knob ↻ to move the Y1 cursor to the top of the signal.
- Press **Y1--/Y2--** softkey or press the entry knob to select Y2 cursor.
- Rotate the entry knob ↻ to move the Y2 cursor to the bottom of the signal.
- ΔY displayed in the softkey area is the voltage difference D (or 2B) between Y1 and Y2.

Application Examples

- Press **Y1-/Y2** softkey or press the entry knob to select Y1 cursor.
- Rotate the entry knob to move the Y1 cursor to the upper intersection of the signal and Y axis.
- Press **Y1-/Y2** softkey or press the entry knob to select Y2 cursor.
- Rotate the entry knob to move the Y2 cursor to the lower intersection of the signal and Y axis.
- ΔY displayed in the softkey area is the voltage difference C (or 2A) between Y1 and Y2.
- Calculate the phase difference using the formula below.

$$\theta = \pm \arcsin \frac{C}{D} \quad \text{or} \quad \theta = \arcsin \frac{A}{B}$$

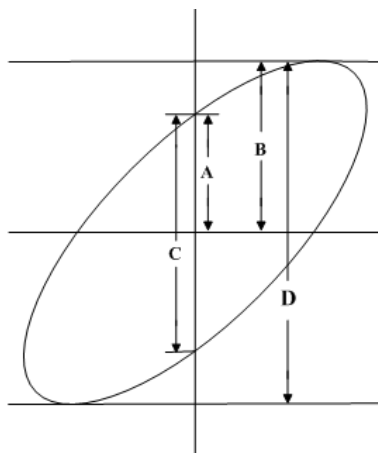

Application Examples

To Output a Sine Waveform

This application example describes how to use the F/A WG to output a sine waveform with 10kHz frequency, 6Vpp amplitude and 1Vdc offset voltage.

Perform the following steps to output the specified sine waveform.

- Connect the WG Output terminal to CH1 terminal.
- Press **ON/OFF** key to enable signal output.
- Press the F/A WG **MENU** key to display the F/A WG menu.
- Press **Output Type** softkey to select the Sine waveform.
- Press **Freq** softkey to select and specify the frequency to 10kHz.
- Press **Ampl** softkey to select and specify the amplitude to 6Vpp
- Press **Offset** softkey to select and specify the offset voltage to 1Vdc
- Press the **GRAPH** key to enable the Graph display.

Application Examples

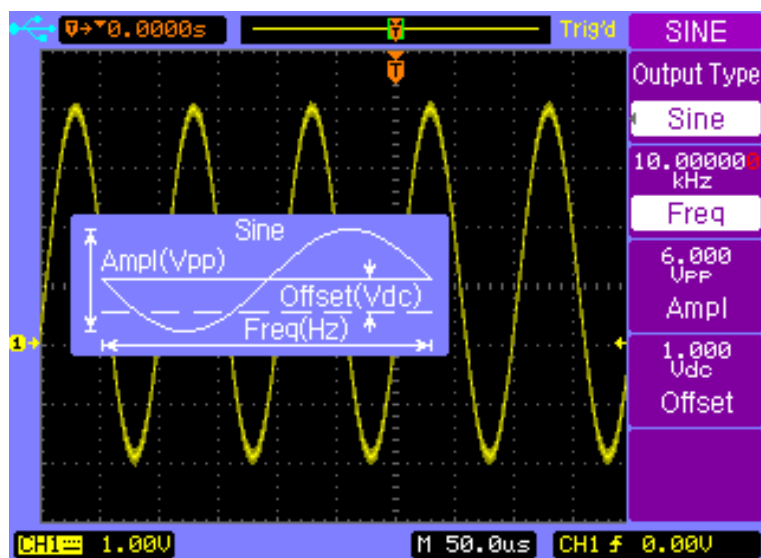

Application Examples

To Output a Amplitude Modulated Waveform

This application example describes how to use the F/A WG to output an amplitude modulated waveform with 100% modulation depth, 10kHz carrier frequency, 600mV carrier amplitude, 100Hz modulating frequency and 0.0mVdc offset.

Perform the following steps to output the amplitude modulated waveform.

- Connect the WG Output terminal to CH1 terminal.
- Press **ON/OFF** key to enable signal output.
- Press the F/A WG **MENU** key to display the F/A WG menu.
- Press **Output Type** softkey to select AM modulation.

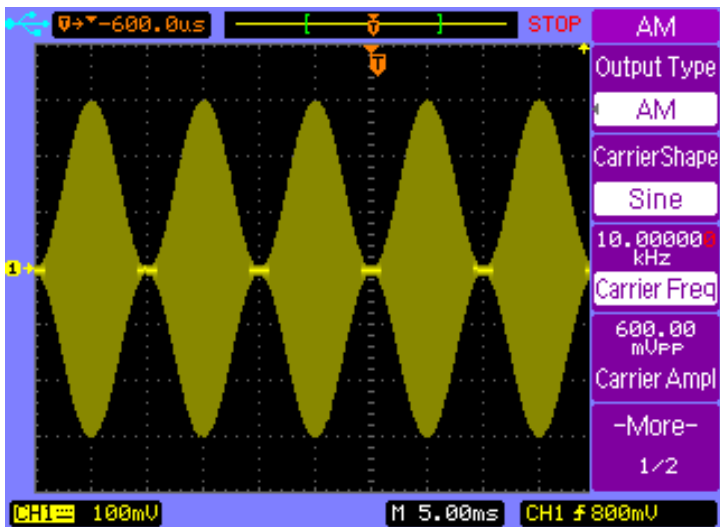

Application Examples

- Press **Carrier Freq** softkey to select and specify the carrier frequency to 10kHz.
- Press **Carrier Ampl** softkey to select and specify the carrier amplitude to 600mVpp.
- Press **More 1/2** softkey to display the **AM** menu page 2/2.

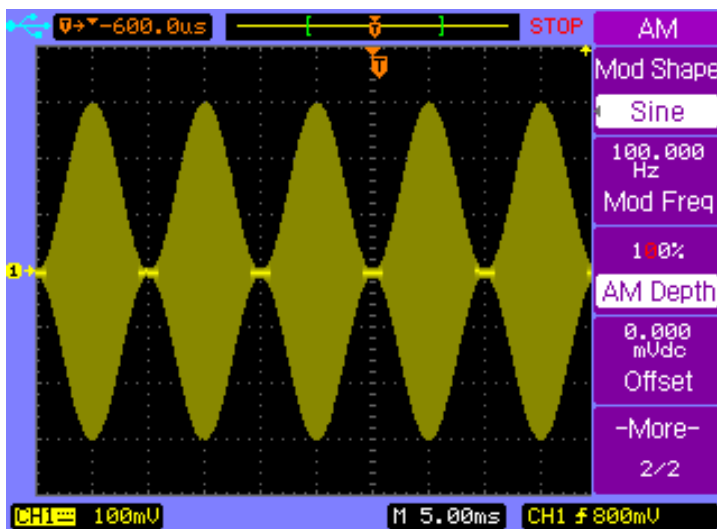

- Press **Mod Shape** softkey and select Sine as the modulating waveform shape.
- Press **Mod Freq** softkey to select and specify the modulating waveform frequency to 100Hz.
- Press **AM Depth** softkey to select and specify the modulation depth to 100%.
- Press **Offset** softkey to select and specify the offset voltage to 0.0mVdc

4. System Message and General Problems

System Message

Function is not available: The control knob, key, or softkey is not available under a specific operating condition. This message will be displayed when you try to operate these knob, key, or softkey.

The control is at its limit: This message will be displayed when the maximum or minimum value is reached by turning the Entry knob, Vertical Control knobs, Horizontal Control knobs, or Trigger Level knob.

Total is at its maximum: This message will be displayed when the maximum value of Total count for PASS/FAIL is reached.

Record is completed: This message will be displayed when the number of waveforms (set in the **End Frame** softkey) have been recorded or when you press the **Operate** softkey to stop the record process manually.

System Message and General Problems

No external memory: This message will be displayed when you try to save a file to an external mass storage device which has not been installed.

Save error: This message will be displayed when you fail to save a file to the internal or external memory.

Empty storage memory: This message will be displayed when you try to load a file which does not exist from the internal memory.

Unrecognized file: This message will be displayed when you try to load a file which can not be recognized by the oscilloscope from the external memory.

Update failed: This message will be displayed when software update is failed.

No record data: This message will be displayed when you try to save or playback a record without record data.

Record is aborted: This message will be displayed when **Operate** softkey is pressed to stop record process without any waveform data recorded.

Factory setup is recalled: This message will be displayed when the default factory configuration is recalled.

System Message and General Problems

No signal is found: This message will be displayed when you press the **AUTO** key without any signal connected to each channel.

Invalid data: This message will be displayed when you try to save a *.CSV , *.TRC or *.WFM file without any valid waveform data.

Load finished: This message will be displayed when a file has been successfully loaded from the internal or external memory.

Save finished: This message will be displayed when a file has been successfully saved to the internal or external memory.

Incompatible file: This message will be displayed when the update software is not match with the model type.

Load error: This message will be displayed when you fail to load a file from the internal or external memory.

Restart to complete updating: This message will be displayed to let you restart the oscilloscope when the software update is successfully finished.

System Message and General Problems

USB device is installed: This message will be displayed when a USB device is connected and recognized by the oscilloscope.

USB device is removed: This message will be displayed when a USB device is removed from the oscilloscope.

USB error: This message will be displayed when the USB control circuit is not working normally.

No help file: This message will be displayed when no help file is loaded or the loaded help file is destroyed.

Digital filter is closed: This message will be displayed when digital filter is closed automatically.

System Message and General Problems

General Problems

If there is no display on the screen.

- Check that the power cord is connected to the oscilloscope and to a live power source.
- Check that the power switch is on.
- Contact our engineer if there is still no display.

If there is no waveform displayed.

- Check that the oscilloscope probe lead wires are securely inserted into the connector assembly and that the probe clips make good contact with the probe lead wires.
- Check that the probe clips are securely connected to points in the circuit under test and that the ground is connected.
- Check that the circuit under test is power on.
- Press the **AUTO** key again.

If the waveform display is not stable.

- Check that the trigger Source channel is actually the channel to which the trigger signal is connected.
- Check that the proper trigger type is selected. Video type is only used to trigger a Video signal. Proper trigger type is essential to acquire a stable display.

System Message and General Problems

- Try to use the HF Reject or LF Reject to reduce the noise of the trigger signal.

If the amplitude is not identical with the actual voltage.

- Check that the attenuation factor of the probe is identical with the attenuation factor set in the channel menu.

5. Specifications and Characteristics

Specifications

All specifications are warranted. Specifications are valid after a 30 minutes warm-up time and within $\pm 5^{\circ}\text{C}$ of last “Self-Cal” temperature.

Bandwidth	25MHz: TDO3022A 60MHz: TDO3062A/TDO3062B 100MHz: TDO3102A/TDO3102B 200MHz: TDO3202B
DC Vertical	2 mV/div, 5 mV/div: $\pm 4\%$
Gain Accuracy	10 mV/div to 5 V/div: $\pm 3\%$

Specifications and Characteristics

Characteristics

All characteristics are the typical performance values and are not warranted. Characteristics are valid after a 30 minute warm-up time and within $\pm 5^{\circ}\text{C}$ of last "Self-Cal" temperature.

Vertical system

Scope channels	2 channels plus external trigger input.
Bandwidth	25MHz: TDO3022A 60MHz: TDO3062A/ TDO3062B 100MHz: TDO3102A/ TDO3102B 200MHz: TDO3202B
Calculated rise time ($=0.35/\text{bandwidth}$)	<14.0ns: TDO3022A <5.83ns: TDO3062A/ TDO3062B <3.50ns: TDO3102A/ TDO3102B <1.75ns: TDO3202B
Coupling	AC, DC and GND
BW Limit	20MHz selectable except TDO3022A
DC Vertical Gain Accuracy	2 mV/div, 5 mV/div: $\pm 4\%$ 10 mV/div to 5 V/div: $\pm 3\%$
DC Measurement	2 mV/div to 5 mV/div: $\pm(4\% \times \text{reading} + 0.1 \times \text{V/div} + 0.5 \text{ mV})$ 10 mV/div to 5 V/div: $\pm(3\% \times \text{reading} + 0.1 \times \text{V/div} + 1.0 \text{ mV})$
Position range	± 8 divisions away from the center of the screen
Attenuation factor	$\times 1$, $\times 10$, $\times 100$, $\times 1000$

Specifications and Characteristics

Channel common mode rejection	100:1 at 60Hz 20:1 at 10MHz ^[1]
Lower frequency limit, AC coupled	≤5Hz at BNC ≤1Hz when using a 10X passive probe
Channel to channel crosstalk	≥100:1 at 1MHz ≥100:1 at 10MHz ^[1]
Input Impedance	1MΩ 18pF
Maximun input	400V _{pk} @1MΩ
Differential delay	±150ps when vertical scale and coupling settings are identical

^[1] Bandwidth reduced to 6MHz with a 1X probe.

Horizontal system

Time base range (1-2-5 step)	TDO3022A: 10 ns/div to 50 s/div, TDO3062A/TDO3102A: 5 ns/div to 50 s/div TDO3062B/TDO3102B/TDO3202B: 2ns/div to 50 s/div
Modes	Main, Delayed, Roll and X-Y
Time base accuracy	±0.01%
Input of X-Y mode	Channel 1 is the horizontal X-axis input Channel 2 is the vertical Y-axis input
Bandwidth of X-Y mode	25MHz: TDO3022A 60MHz: TDO3062A/TDO3062B 100MHz: TDO3102A/TDO3102B
Phase error of X-Y mode	±3°

Specifications and Characteristics

Measurements

Voltage measurement	Max, Min, VPP, High, Low, Amplitude, Average, RMS, Overshoot, Preshoot, Cycle average, Cycle RMS
Time measurement	Frequency, Period, Rise time, Fall time, +Width, -Width, +Duty, -Duty, Delay, Phase, X@MAX, X@MIN
Math	A+B, A-B, AxB, FFT (1024 points)
Cursors	Manual, Auto, and Track
Counter	Built-in 5-digit frequency counter. Count up to the oscilloscope's maximum bandwidth.

Specifications and Characteristics

Trigger system

Source	CH1, CH2, EXT, EXT/5, AC Line, Alternating.
Modes	Auto, Normal, Single
Coupling	DC, AC, LF-Reject, HF-Reject
Type	Edge, Pulse, Video
Trigger level range	Internal: ± 8 divisions from screen center EXT: $\pm 1.6V$ EXT/5: $\pm 8V$
Trigger sensitivity	0.1div to 1.0 div user adjustable
EXT input impedance	$1M\Omega 18pF$
EXT maximum input	$400V_{pk}$ @ $1M\Omega$
Video Standard	Supports NTSC, PAL, and SECAM broadcast systems for any field or any line
Holdoff Range	100ns to 1.5s
Trigger Level Accuracy	Internal: $\pm 0.3 \text{ div} \times \text{volts/div}$
SET LEVEL TO 50%	Operates with input signal $\geq 50 \text{ Hz}$.
Pulse Width Trigger mode	Trigger when Less than, Greater than, Equal, Positive pulse , Negative pulse
Pulse Width Range	20ns to 10s

Specifications and Characteristics

Storage and I/O

Internal memory	10 setups and trace files can be saved and recalled internally.
File format	Setup file(*.STP), Waveform file(*.WFM), Trace file(*.TRC), BMP file(*.BMP), CSV file(*.CSV)
Standard ports	USB host USB device RS232C PASS/FAIL OUT LAN (B series only)

Specifications and Characteristics

Acquisition system

Max real time sample rate	A Series: 400Msps B Series: 1Gsps	
Max equivalent sample rate	A Series: 20Gsps B Series: 50Gsps	
Max Memory Depth (Based on Sample rate)	A Series	400MSa/s: 2.4Mpts ≤200MSa/s: 1.2Mpts
	B Series	1GSa/s: 16kpts 500MSa/s: 8kpts(dual channel) 500MSa/s: 2.4Mpts(single channel) ≤250MSa/s: 1.2Mpts
Vertical resolution	8 bits	
Sample mode	Normal, Average, Peak Detect	
Autoset	<p>Finds and displays all active channels, sets edge trigger mode on channel 1, set vertical sensitivity on scope channels and time base to display one or five periods.</p> <p>Requires minimum voltage >10mVpp, 0.5% duty and minimum frequency >50Hz.</p>	

Specifications and Characteristics

Display system

Display	5.6-inch TFT LCD display.
Resolution	234 vertical by 320 horizontal pixels
Colour	24 bit true color
Brightness	Adjustable
Language	Simplified Chinese, Traditional Chinese, English, Korean, Japanese, Russian, French, Spanish, Persian, Portuguese
Display area	Menu ON: 8 vertical by 10 horizontal divisions or 200 vertical by 250 horizontal pixels Menu OFF: 8 vertical by 12 horizontal divisions or 200 vertical by 300 horizontal pixels
Display mode	Vector, Dots
Interpolation	Sinx/x, Linear
Persistence	OFF, Infinite persistence

Specifications and Characteristics

Function/Arbitrary Waveform Generator Specifications

Frequency Characteristics

Model	TDO3022AS	TDO3062AS TDO3062BS	TDO3102AS TDO3102BS TDO3202BS
Max output frequency	10MHz	20MHz	40MHz
Sine, Square waveform	1μHz to 10MHz	1μHz to 20MHz	1μHz to 40MHz
Pulse waveform	1mHz to 10MHz		
Built-in ARB	1mHz to 1MHz		
User ARB	1mHz to 1MHz		
Frequency resolution	Sine, Square: 1μHz		
	Pulse, Built-in ARB, User ARB: 1mHz		
Frequency accuracy	$\leq \pm 5 \times 10^{-4}$		
Frequency stability	$\pm 5 \times 10^{-5}$		

Sine Characteristics

Harmonic Distortion	<5MHz: -50dBc
	≤ 10 MHz: -45dBc
	> 10MHz: -40dBc
Total harmonic distortion	20Hz to 100kHz: $\leq 0.2\%$

Pulse Characteristics

Duty	0.01% to 99.99%
Width	10ns to 999.99s

Specifications and Characteristics

Amplitude Characteristics

Amplitude range	When freq. \leq 20MHz, 2mVpp to 20 Vpp When freq. > 20MHz, 2mVpp to 6 Vpp
Max resolution	2 μ Vp-p
Amplitude accuracy	$\leq \pm 5\% \pm 1\text{mV}$ @1kHz sine waveform
Amplitude stability	$\pm 2\%$ in 4 hours
Amplitude flatness (Sine, Square, Pulse)	When freq. \leq 5 MHz: $\pm 5\%$ When freq. > 5MHz: $\pm 10\%$
Amplitude flatness (Built-in ARB)	When freq. \leq 50 kHz: $\pm 5\%$ When freq. > 50kHz: $\pm 20\%$
Output impedance	50 Ω

AM Modulation Characteristics

Carrier waveforms	Sine, Square
Modulating waveforms	30 commonly used waveforms, including Sine, Square, Triangle etc.
Modulation frequency	1mHz to 1MHz
Modulation depth	0% to 120%

FM Modulation Characteristics

Carrier waveforms	Sine, Square
Modulating waveforms	30 commonly used waveforms, including Sine, Square, Triangle etc.
Modulation frequency	1mHz to 1MHz
Modulation deviation	0.1% to 99.9%

Specifications and Characteristics

PWM Modulation Characteristics

Carrier waveform	Pulse
Modulating waveforms	30 commonly used waveforms, including Sine, Square, Triangle etc.
Modulation frequency	1mHz to 1MHz
Width deviation	1% ~ 99%

FSK Modulation Characteristics

Carrier waveform	Sine	
Hop frequency	TDO3022AS	1μHz to 10MHz
	TDO3062AS TDO3062BS	1μHz to 20MHz
	TDO3102AS TDO3102BS TDO3202BS	1μHz to 40MHz
	Interval time	
	1ms to 40s	

PSK Modulation Characteristics

Carrier waveform	Sine
Hop phase	0° to 360°
Interval time	1ms to 40s

Specifications and Characteristics

DCOM Modulation Characteristics

Carrier waveforms	Sine, Square
Modulating waveforms	30 commonly used waveforms, including Sine, Square, Triangle etc.
Modulation frequency	1mHz to1MHz
Function description	Realize addition of carrier waveform and modulating waveform

Frequency Sweep Characteristics

Waveforms	Sine, Square		
Frequency range	Amplitude ≤6Vpp	TDO3022AS	1μHz to 10MHz
		TDO3062AS	1μHz to 20MHz
		TDO3062BS	
		TDO3102AS	1μHz to 40MHz
		TDO3102BS	
		TDO3202BS	
	Amplitude >6Vpp	TDO3022AS	1μHz to 10MHz
		TDO3062AS	1μHz to 20MHz
		TDO3062BS	
		TDO3102AS	1μHz to 20MHz
TDO3102BS			
TDO3202BS			
Sweep mode	Up, Down, Up-Down		
Sweep time	1ms to 500s		

Specifications and Characteristics

Burst Characteristics

Waveforms	30 commonly used waveforms, including Sine, Square, Triangle etc.
Counts	1 to 60000 cycles
Burst frequency	1mHz to 1MHz

Modulating Waveform Characteristics

Output frequency	1mHz to 1MHz
Output waveform	30 commonly used waveforms, including Sine, Square, Triangle etc.
Output amplitude	5Vpp \pm 20%
Output impedance	600 Ω

DC Offset Characteristics

Offset range	Amplitude range
-10mVdc to +10mVdc	2mVpp to 6.32mVpp
-31.6mVdc to +31.6mVdc	6.321mVpp to 20mVpp
-100mVdc to +100mVdc	20.001mVpp to 63.2mVpp
-316mVdc to +316mVdc	63.201mVpp to 200mVpp
-1Vdc to +1Vdc	200.01mVpp to 632mVpp
-3.16Vdc to +3.16Vdc	632.01mVpp to 2Vpp
-10Vdc to +10Vdc	2.001Vpp to 6.32Vpp
-2Vdc to +2Vdc	6.321Vpp to 20Vpp

Specifications and Characteristics

Power and environmental requirements

Line voltage Range	99V to 242VAC
Line frequency	47Hz to 440Hz
Power consumption	Less than 50VA
Operating temperature	0°C to 40°C
Non-operating temperature	-20°C to 55°C
Humidity	Maximum relative humidity 80% for temperatures up to 31°C decreasing linearly to 50% relative humidity at 40°C
Operating altitude	≤3000m
Non-operating altitude	≤15000m

Physical size and Weight

Instrument height	156.5 mm
Instrument width	320 mm
Instrument depth	123 mm
Net weight	Approximately 2.8 kg

Calibration interval

Recommended calibration interval	One year
----------------------------------	----------