

---

# User's Manual

---

TDO1000/TDO2000  
Series Oscilloscopes

---

# Manual Print History

The manual print history shown below lists all the printing dates and editions. The printing date changes when a new edition is released. The latest editions can be downloaded from our website.

- March 2007 ..... First Edition
- January 2008 ..... Second Edition
- March 2008 .....Third Edition
- April 2008.....Fourth Edition

---

# Warranty

This Tonghui instrument product is warranted against defects in material and workmanship for a period of two years from the date of shipment. Other items such as test fixtures, test cables are warranted for 90 days from the date of shipment. During the warranty period, we will, at our option, either repair or replace products which prove to be defective.

For warranty service or repair, this product must be returned to a service facility designated by Tonghui. Purchaser shall prepay shipping charges to Tonghui and Tonghui shall pay for the return of the product to Buyer. However, Buyer shall pay all shipping charges, duties, taxes, and any other charges for products returned to Tonghui from another country.

---

# Limitation of Warranty

This warranty does not apply to defects resulting from improper or inadequate maintenance and care by Buyer, Buyer-supplied software or interfacing, unauthorized modification or misuse, operation outside of the environmental specifications for the product, or improper site preparation or maintenance.

No other warranty is expressed or implied. Tonghui specially disclaims the implied warranties of merchantability and fitness for a particular use.

Tonghui's responsibility to repair or replace defective products is the sole and exclusive remedy provided to the customer for breach of this warranty. Tonghui shall not be liable for any direct, indirect, special, incidental, or consequential damages, whether based on contract, tort, or any other legal theory.

---

# Safety Precautions

The following safety precautions must be observed to avoid injury and prevent damage to this product or any products connected to it. To avoid potential hazards, read the operating information carefully before using the product and use this product only as specified.

---

**NOTE** This product complies with INSTALLATION CATEGORY I as well as POLLUTION DEGREE 2. This product is an INDOOR USE product.

---

- Ground the Instrument

Before operating the instrument, make sure the instrument chassis is grounded with the 3-pole power cable.

- Don't operate in an explosive atmosphere

To prevent explosion or fire, don't operate the instrument in the presence of inflammable gases or fumes.

- 
- Use the proper fuse

Replace the broken fuse with the same type and rating for continuous protection against fire hazard.

- Keep away from live circuits

Don't remove the instrument covers when operating the instrument. Component replacement and internal adjustment can only be done by qualified personnel.

Don't replace components with the power cable connected. Dangerous voltage may remain even after the power cable has been disconnected. Always remove the power cable from the instrument and discharge circuits before touching them.

# Contents

---

## Contents

Contents .....	7
1. Getting Started.....	10
Inspect package contents .....	10
Front Panel .....	11
Naming regulation.....	17
Rear panel.....	18
Interpreting the display.....	19
2. Basic Operation .....	21
Probe Compensation.....	21
Using Autoset .....	23
Vertical Controls.....	25
CH1, CH2 Menu.....	28
MATH Functions .....	39
REF Function.....	46
Horizontal Controls .....	49

# Contents

---

Trigger Controls.....	62
ACQUIRE Menu .....	75
UTILITY Menu .....	85
MEASURE Menu .....	101
SAVE/LOAD Menu .....	115
CURSOR Menu.....	126
DISPLAY Menu .....	132
RUN Controls.....	135
3. Application Examples .....	137
Make Simple Measurements.....	137
Capture a Single-Shot Signal.....	139
Reduce the Random Noise on a Signal .....	141
Trigger on a Video Signal .....	143
PASS/FAIL Measurement.....	145
Waveform Recorder .....	147
Cursor Measurements.....	150



# Contents

---

4. System Message and General Problems.....	157
System Message .....	157
General Problems.....	161
5. Specifications and Characteristics.....	163
Specifications .....	163
Characteristics.....	164

# 1. Getting Started

### Inspect package contents

Inspect the shipping container for damage. If the shipping container or cushioning material is damaged, it should be kept until the contents of the shipment have been checked for completeness and the oscilloscope has been checked mechanically and electrically.

Verify that you received the following items and any optional accessories you may have ordered.

- TDO1000 or TDO2000 Series Oscilloscope
- Two oscilloscope probes
- Power cord
- User's Manual

If the contents are incomplete, if there is mechanical damage or defeat, please contact us.

# Getting Started

## Front Panel

This section provides an introduction to the front panel of the TDO1000 and TDO2000 Series Oscilloscopes. Generally, you set up the front panel controls first and then perform a measurement.

The keys or knobs on the front panel bring up softkey menus on the display that provide further access to oscilloscope features. Entry knob  is usually used to select or input values. Five softkeys are located along the right side of the display screen.

The following figure shows the front panel of the TDO1000 and TDO2000 Series Oscilloscopes.

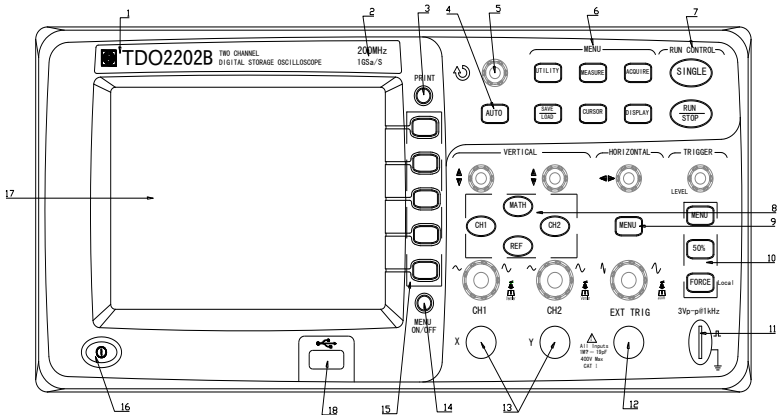

Front panel

# Getting Started

---

## 1. Trademark and Model

Indicate the oscilloscope model and trademark of the manufacturer.

## 2. Bandwidth and Sample Rate

Indicate the bandwidth and sample rate of the current oscilloscope model.

## 3. **PRINT** key

Press this key to print the current waveform display to a USB printer or to a USB mass storage device.

## 4. **AUTO** key

When you press the **AUTO** key, the oscilloscope will quickly determine which channels are active, and it will turn these active channels on and scale them to display the input signals.

## 5. Entry knob ↻

The Entry knob is used to select items from menus and input values. Its function changes when different menu is displayed. The curved arrow symbol ↻ to the left of the Entry knob illuminates when the Entry knob is active and can be used to select a value.

## 6. MENU keys

When you press a menu key on the front panel, the oscilloscope will display the corresponding menu on the right side of the screen. The menu shows the options that are available when you press the softkeys directly to the

## Getting Started

---

right of the screen. There are totally six menu keys available:

### **UTILITY**

Activate the system utility functions, such as Language Setup, I/O Setup, and Print Setup etc.

### **MEASURE**

Perform automated measurements of waveforms.

### **ACQUIRE**

The ACQUIRE menu lets you set the oscilloscope to acquire in Normal, Peak Detect, or Average mode, and lets you select Real Time or Equivalent sampling.

### **SAVE/LOAD**

You can save your current setup and waveform to the oscilloscope's internal memory or to a USB mass storage device, and then retrieve the setup or waveform later.

### **CURSOR**

Press the **CURSOR** key to activate the cursors that you can use for making custom voltage or time measurement on scope signals.

### **DISPLAY**

You can change the appearance of waveforms and the display screen, select the color schemes and adjust the contrast etc.

## Getting Started

---

### 7. RUN control keys

The **RUN/STOP** key will illuminate in green when the oscilloscope is looking for a trigger. When the trigger mode is set to Normal mode, the display will not update until a trigger is found. If the trigger mode is set to Auto mode, the oscilloscope looks for a trigger, and if no trigger is found, it will be triggered automatically and the waveform of input signals will be showed immediately.

Press the **RUN/STOP** key again to stop acquiring data and the **RUN/STOP** key will illuminate in red. Now you can pan across and zoom in on the acquired waveform.

Press **SINGLE** key to make a single acquisition of data. The key will illuminate in yellow until the oscilloscope is triggered.

### 8. Vertical controls

You can use the vertical position control knob to move the waveforms up or down on the display. There is one vertical position control knob for each channel.

You can press the channel key **CH1** or **CH2** to switch the channel on or off, or access the channel's menu in the softkeys. There is one channel on/off key for each channel.

You can press the **MATH** key to access FFT (Fast Fourier Transform), multiply, subtract, and add functions.

# Getting Started

---

You can press the **REF** key to save or load a reference waveform from the internal memory or external USB mass storage device.

You can use the vertical scale control knob to change the vertical scale of a waveform. The waveform display will contract or expand relative to the ground reference level. There is one vertical scale control knob for each channel.

## 9. Horizontal controls

When the oscilloscope is running, the horizontal position control knob lets you set the acquisition window relative to the trigger point. When the oscilloscope is stopped, you can turn this knob to pan through the data horizontally. This let you see the captured waveform before or after the trigger.

Press the horizontal **MENU** key to access the menu where you can split the oscilloscope display in Main and Delayed section, and where you can select X-Y and Roll modes.

Turn the horizontal sweep speed control knob to adjust the sweep speed. This changes the time base on the display. When adjusted after the waveform has been acquired and the oscilloscope is stopped, this has the effect of stretching out or squeezing the waveform horizontally.

# Getting Started

---

## 10. Trigger controls

These controls are used to control how the oscilloscope triggers to capture waveforms.

## 11. Probe compensation terminals

Use these two probe compensation terminals to match each probe's characteristics to the oscilloscope channel to which it is connected.

## 12. External trigger input

This is the external trigger input BNC connector.

## 13. Channel input BNC

This is the channel's input BNC connector. Connect the oscilloscope probe or BNC cable to the BNC Connector.

## 14. **MENU On/Off** key

Press this key to toggle menu display on and off.

## 15. Softkeys

Five softkeys are used to select control and parameter functions. Each softkey has a softkey label along its left side.

## 16. Power switch

Press once to turn power on, press again to turn power off.

## 17. LCD display

The 320\*240 matrix (5.7 inch) LCD displays captured channel waveforms, setup information, measurement results and softkeys for setting up parameters.



# Getting Started

---

## 18. USB host Connector

USB host connector can be connected to an USB mass storage device or an USB printer.

## Naming regulation

Take TDO1042A as an example to describe the naming regulation of the TDO1000/ TDO2000 Series Oscilloscopes.

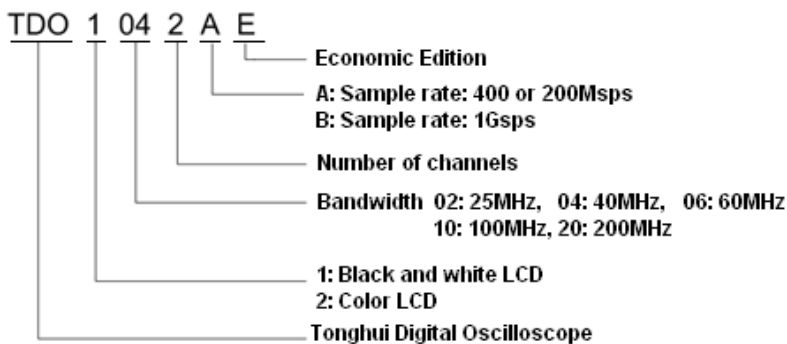

## Naming regulation

# Getting Started

---

## Rear panel



### Rear panel

**1. Line input receptacle**

AC power cord receptacle. Attach to an AC power line with safety ground.

**2. USB device connectors**

USB device connector can be connected to a computer.

**3. Extended port**

An optional extended module can be connected to provide RS232C, GPIB, and PASS/FAIL OUT interfaces.

# Getting Started

## Interpreting the display

The oscilloscope display contains channel acquisitions, setup information, measurement results, and softkeys for setting up parameter.

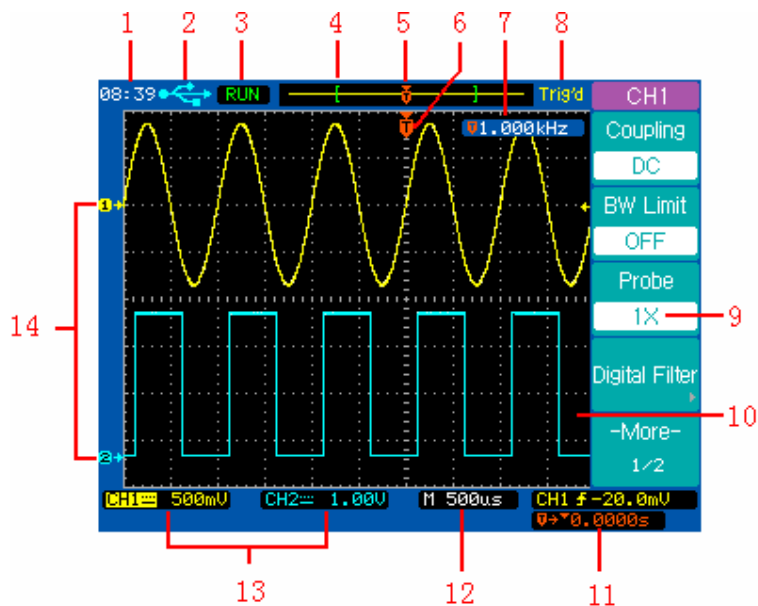

### Interpreting the display

1. Readout shows the real time clock.
2. The USB icon displays when a USB device is connected.
3. Acquisition status readout shows RUN, STOP, WAIT, or ROLL.

## Getting Started

---

4. The square brackets show the location of current display window within the record. The record line color corresponds to the selected waveform color.
5. Trigger position icon shows the trigger location within the record.
6. Trigger position icon shows the trigger location in the current displayed waveforms
7. Readout shows the frequency of the trigger signal.
8. Trigger status readout shows trigger status.
9. Softkeys which allow you to set up additional parameters for front-panel keys.
10. The display area contains the waveform acquisitions, channel identifiers, trigger and ground level indicators. Each channel's information appears in a different color.
11. Readout shows the delay setting or the trigger location within the record, trigger source, trigger type, and trigger level.
12. Horizontal readout shows the Main or Delayed time base.
13. Channel readouts show the scale factor, coupling, bandwidth limit, digital filter, and invert status.
14. Waveform baseline icons show the zero-volt level of the waveforms. The icon colors correspond to the waveform colors.

## 2. Basic Operation

### Probe Compensation

Perform this adjustment to match your probe to the input channel. This should be done whenever you attach a passive probe for the first time to any input channel. A poorly compensated probe can introduce measurement errors.

1. Connect the oscilloscope probe to channel 1. Attach the probe tip and reference lead to the 3Vp-p@1kHz terminal and to the chassis terminal, then press **AUTO** key.
2. Use a nonmetallic tool to adjust the trimmer capacitor on the probe for the flattest pulse possible. The trimmer capacitor is located on the probe BNC connector.

**Perfect compensated**

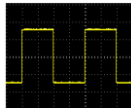

**Over compensated**

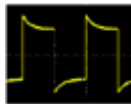

**Under compensated**

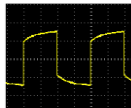

## Basic Operation

---

3. Connect probes to all other oscilloscope channels. Repeat the procedure for each channel. This matches each probe to each channel.

# Basic Operation

---

## Using Autoset

TDO1000 and TDO2000 Series Digital Storage Oscilloscopes provide the Autoset function which sets the vertical, horizontal, and trigger controls automatically.

Autoset function finds, turns on, and scales any channel with a repetitive waveform that has a frequency of at least 50 Hz, a duty cycle greater than 0.5%, and an amplitude of at least 10mV peak-to-peak. Any channels that do not meet these requirements are turned off.

When you are using more than one channel, the Autoset function sets the vertical controls for each channel and used the lowest-numbered active channel to set the horizontal and trigger controls.

To configure the oscilloscope quickly and automatically, press the **AUTO** key to display the connected signals that are active.

To configure the oscilloscope to display multiple cycles, press **Multi-Cycle** softkey in the **AUTO** menu.

To configure the oscilloscope to display a single cycle, press **Single Cycle** softkey in the **AUTO** menu.

To undo the effects of Autoset, press the **Undo Autoset** softkey in the **AUTO** menu before pressing any other key.

## Basic Operation

This is useful when you have unintentionally pressed the **AUTO** key or do not like the settings Autoset has selected and want to return to your previous settings.

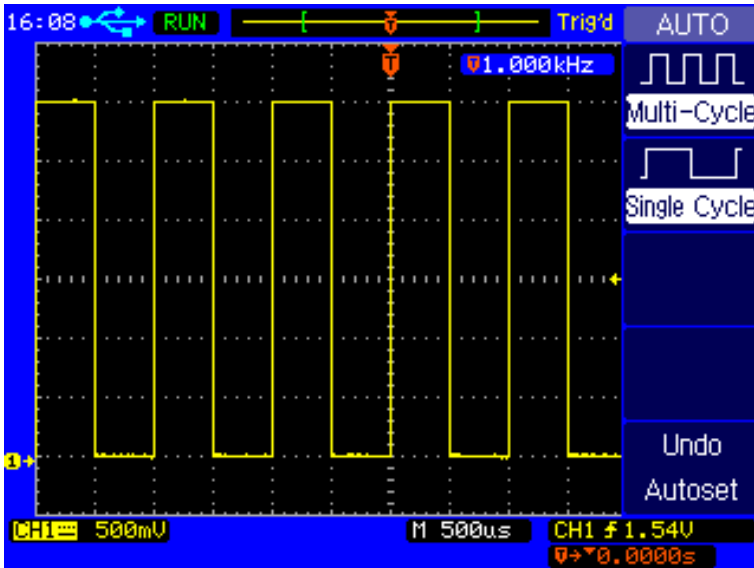

Autoset of oscilloscope channel 1



### Vertical Controls

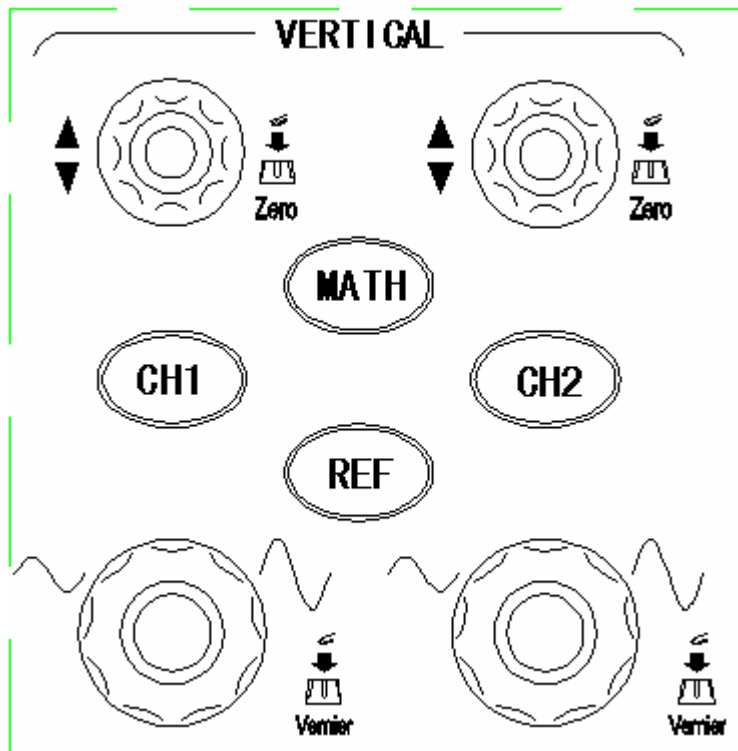

Vertical controls

#### Vertical Position Control (CH1, CH2)

Turn the small vertical position knob above the channel key to move the channel's waveform and its ground level icon ( $\oplus$ ) up or down on the display. The voltage value momentarily displayed in the bottom left portion of the display represents

## Basic Operation

---

the voltage difference between the vertical center of the display and the ground level(**0+**).

Press the small vertical position knob above the channel key to bring the channel's waveform and its ground level icon (**0+**) directly back to the vertical center of the display.

### Channel key **CH1**, **CH2**, **MATH**, **REF**

Press the channel key from the front panel to display the channel's menu and turns the display of the channel on or off. The channel is displayed when the key is illuminated.

You must be viewing the menu for a channel before you can turn it off. For example, if CH1 and CH2 are both displayed and the **CH2** menu is now displayed. In order to turn **CH1** off, you should press the **CH1** key first and **CH1** menu will be displayed, then press **CH1** key again to turn off **CH1**.

### Vertical Scale Control (**CH1**, **CH2**)

Turn the large vertical scale knob below the channel key to set the scale factor for the channel. The vertical scale knob changes the channel scale in a 1-2-5 step sequence. The channel scale factor value is displayed in the bottom left portion of the display.

Press the large vertical scale knob to toggle between Fine and Coarse. When fine is selected, you can change the

## Basic Operation

---

channel's vertical sensitivity in smaller resolution. When coarse is selected, the vertical scale knob changes the channel scale in a 1-2-5 step sequence.

# Basic Operation

## CH1, CH2 Menu

Press the channel key **CH1** to display the channel's menu and turns the display of the channel on.

## Channel Coupling

Press the channel key **CH1**, then press the **Coupling** softkey to select AC coupling mode.

AC coupling places a high pass filter in series with the input waveform that blocks the DC component of the input signal. AC coupling is useful for viewing waveforms with large DC offsets.

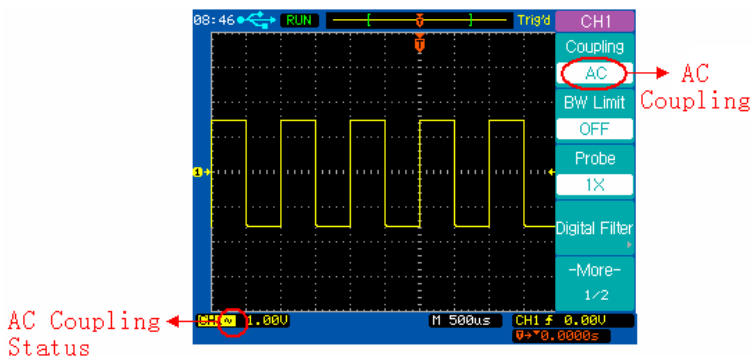

AC Coupling

# Basic Operation

Press the channel key **CH1**, then press the **Coupling** softkey to select DC coupling mode.

DC coupling passes both AC and DC components of the input signal. DC coupling is useful for viewing low frequency waveforms that do not have large DC offsets.

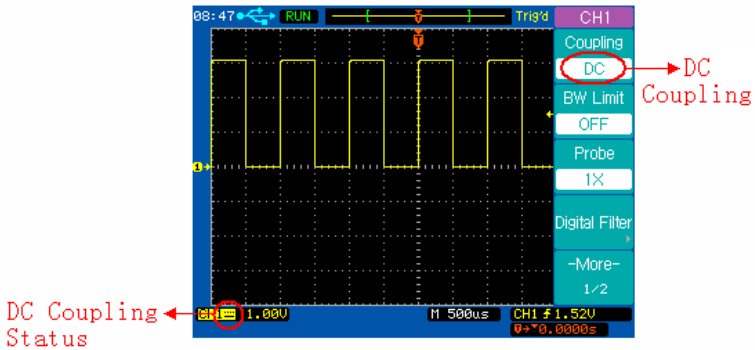

**DC Coupling**

## Basic Operation

Press the channel key **CH1**, then press the **Coupling** softkey to select GND coupling mode.

GND mode blocks both AC and DC components of the input signal and connect the input to the ground level.

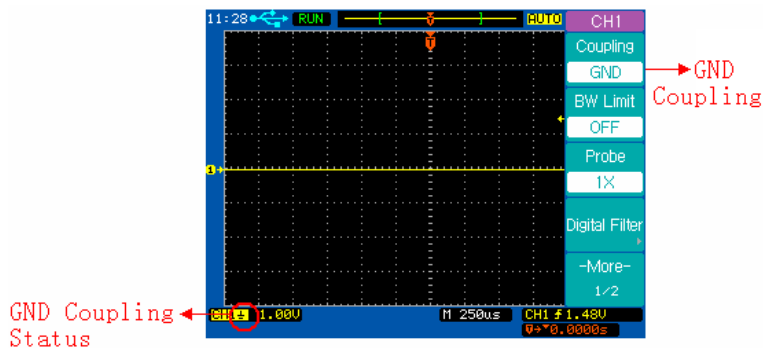

### GND Coupling

# Basic Operation

## BW Limit

When BW Limit is on, the maximum bandwidth for the channel is approximately 20MHz. For waveforms with frequencies below this, turning bandwidth limit on removes unwanted high frequency noise from the waveform. The bandwidth limit also limits the trigger signal path of any channel that has **BW Limit** turned on.

Press the channel key **CH1**, then press the **BW Limit** softkey to turn the bandwidth limit off for the selected channel 1. BW Limit off mode passes both the high and low frequency components.

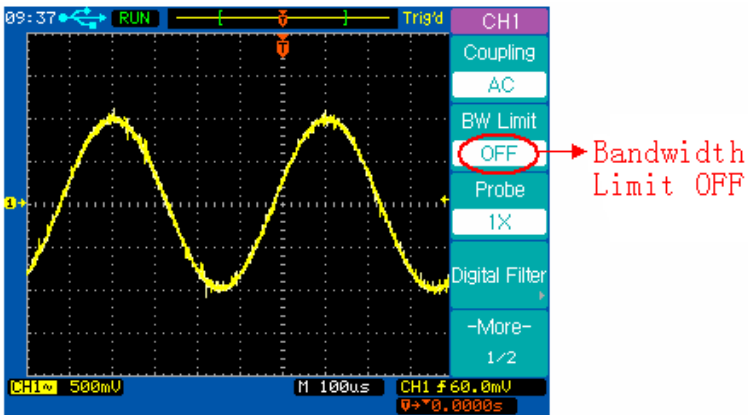

**BW Limit off**

## Basic Operation

Press the channel key **CH1**, then press the **BW Limit** softkey to turn the bandwidth limit on for the selected channel 1. BW Limit on mode blocks the high frequency components over 20MHz.

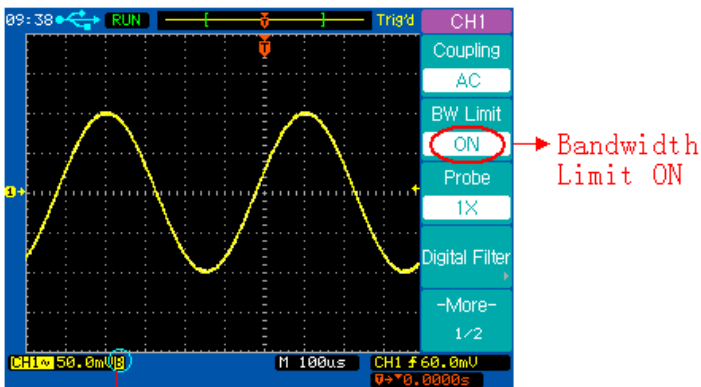

Bandwidth Limit ON Status

**BW Limit on**



# Basic Operation

## Probe Attenuation Setting

Probes are available with various attenuation factors which affect the vertical scale of the signal. You can manually select the factor that matches the attenuation of your probe.

For example, to match a probe set to 10X connected to CH1, press the channel key **CH1**, and then press the **Probe** softkey and select 10X.

Press the channel key **CH1**, then press the **Probe** softkey and select 1X, when a probe with 1:1 attenuation factor is connected to CH1.

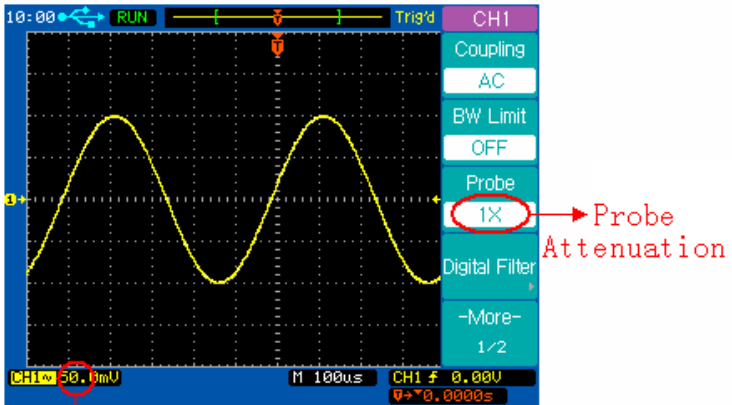

Vertical Scale

Set Probe Attenuation Factor to 1X

## Basic Operation

### Digital Filter

Press the channel key **CH1**, then press the **Digital Filter** softkey to display the **FILTER-CH1** menu. Four kinds of filter types are available:

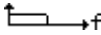
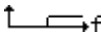
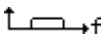
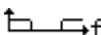
-  Low pass filter
-  High pass filter
-  Band pass filter
-  Band block filter

Press the **Upper Limit** or **Lower Limit** softkey and then adjust the Entry knob  to set the high and low frequency range for the filter.

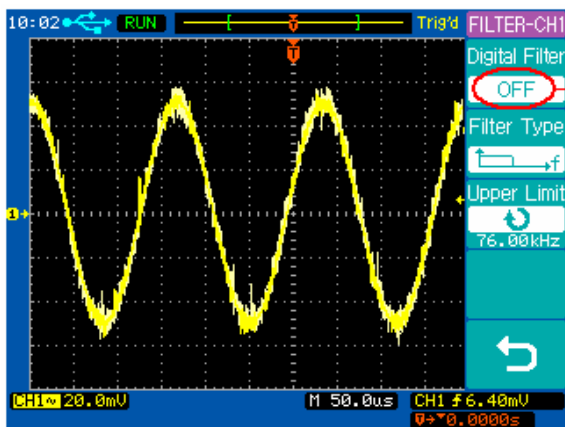

Digital Filter is off

## Basic Operation

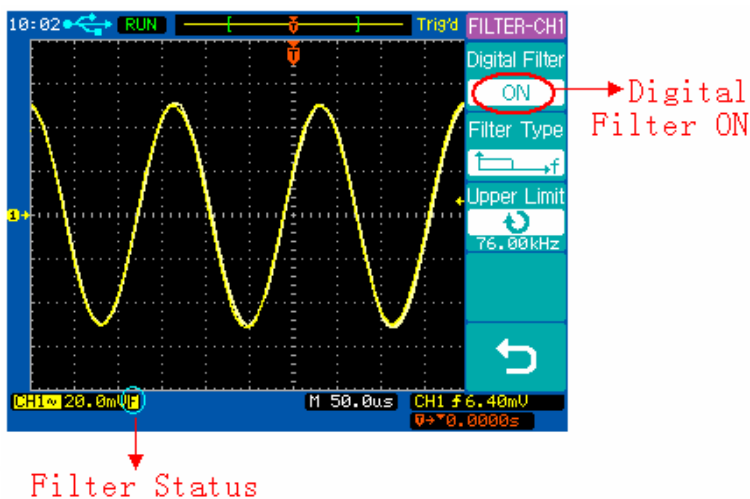

**Digital Filter is on**

# Basic Operation

## Vertical Scale

Turn the large vertical scale knob below the channel key to set the scale factor for the channel. The channel scale factor value is displayed in the bottom left portion of the display.

Press **CH1** → **More 1/2** → **Volts Scale** to select **Coarse** or **Fine** adjustment. You can also press the large vertical scale knob to toggle between **Fine** and **Coarse**. When Coarse is selected, the vertical scale knob changes the channel scale in a 1-2-5 step sequence. When Fine is selected, the vertical scale knob changes the channel scale in a smaller resolution.

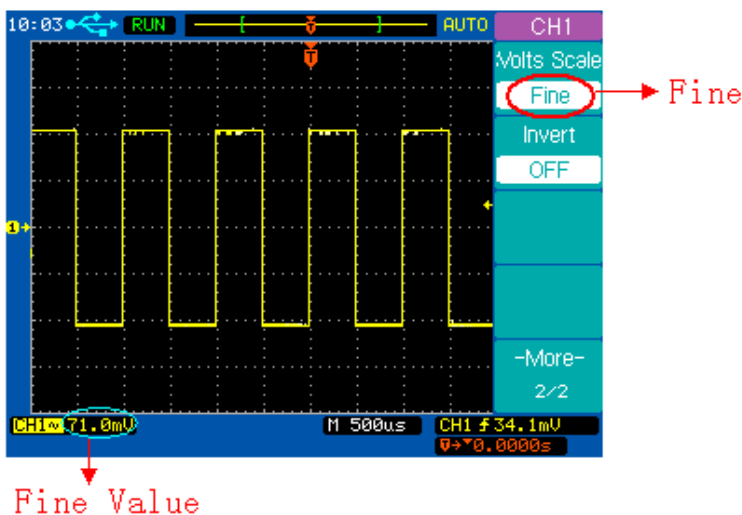

Fine Vertical Scale

# Basic Operation

## Vertical Invert

Press **CH1** → **More 1/2** → **Invert** to set Invert on or off. When Invert is turned on, the voltage values of the displayed waveform are inverted. Invert affects how a channel is displayed, but does not affect triggering. If the oscilloscope is set to trigger on a rising edge, it remains set to trigger on a same edge after the channel is inverted.

Inverting a channel will also change the result of any function selected in the **MATH** menu or any measurement.

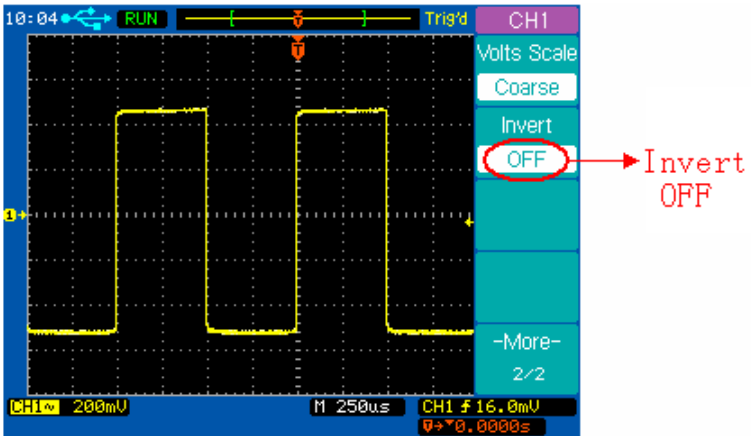

Vertical Invert off

## Basic Operation

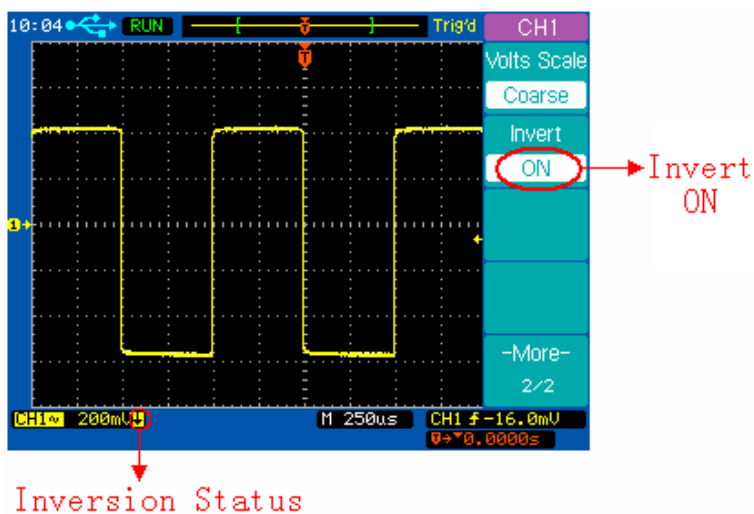

Vertical Invert on

# Basic Operation

## MATH Functions

### Dual Waveform Calculation

Press **MATH** channel key to turn on the **MATH** menu page 1/2.







<b>MATH</b>
Operate
A+B
Source A
CH1
Source B
CH2
Invert
OFF
-More-
1/2

Softkey	Options	Description
<b>Operate</b>	A+B	Add A and B
	A-B	Subtract B from A
	A×B	Multiply A by B
	FFT	Access FFT menu
<b>Source A</b>	CH1	Select CH1 as Source A
	CH2	Select CH2 as Source A
<b>Source B</b>	CH1	Select CH1 as Source B
	CH2	Select CH2 as Source B
<b>Invert</b>	ON	Math invert ON
	OFF	Math invert OFF
<b>More 1/2</b>	----	Select page 2/2

## Basic Operation

---

Press softkey **More 1/2** to display **MATH** menu page 2/2.

MATH	Softkey	Options	Description
Operate	<b>Operate</b>	A+B	Add A and B
A+B		A-B	Subtract B from A
		A×B	Multiply A by B
		FFT	Access FFT menu
			Vertical scale control
Display Mode			Vertical position control
Full Screen	<b>Display Mode</b>	Split Screen	Split the display into Main and Math sections
-More- 2/2		Full Screen	Display Math waveform in full screen
	<b>More 2/2</b>	----	Select page 1/2



## Basic Operation

For example, we select the A+B math function, select CH1 as the Source A, and select CH2 as the Source B, then we will get the math waveform like this.

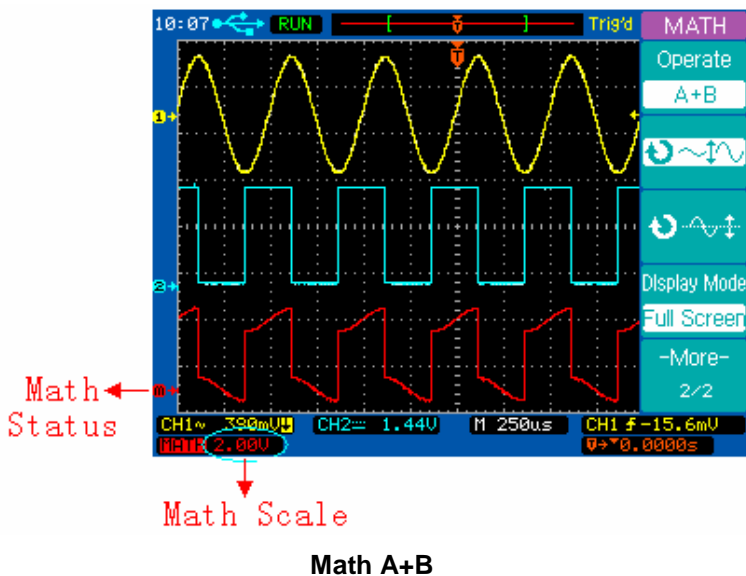

# Basic Operation

---

## **FFT Spectrum Analysis**

You can use the FFT function to measure harmonic component and distortion in systems, to characterize noise in DC power supplies and to analyze vibration.

## Basic Operation

---

Press **MATH** channel key to turn on the **MATH** menu page 1/2, and then press **Operate** softkey to select FFT. The **FFT** menu page 1/2 will be displayed.







FFT
Operate
FFT
Source
CH1
Window
Rectangular
Scale
dBV RMS
-More-
1/2

Softkey	Options	Description
<b>Operate</b>	A+B	Add A and B
	A-B	Subtract B from A
	A×B	Multiply A by B
	FFT	Enter FFT menu
<b>Source</b>	CH1	Select CH1 for FFT
	CH2	Select CH2 for FFT
<b>Window</b>	Hanning	Use Hanning window
	Hamming	Use Hamming window
	Blackman	Use Blackman window
	Flattop	Use Flattop window
	Rectangular	Use Rectangular window
<b>Scale</b>	dBV RMS	Vertical scale in dBV RMS
	V RMS	Vertical scale in V RMS
<b>More 1/2</b>	----	Select page 2/2

## Basic Operation

---

Press softkey **More 1/2** to display **FFT** menu page 2/2.

FFT	<b>Softkey</b>	<b>Options</b>	<b>Description</b>
Operate	<b>Operate</b>	A+B	Add A and B
FFT		A-B	Subtract B from A
		A×B	Multiply A by B
		FFT	Enter FFT menu
	<b>Display Mode</b>		Vertical scale control
			Vertical position control
Display Mode	<b>Display Mode</b>	Split Screen	Split the display into Main and Math sections
Full Screen		Full Screen	Display Math waveform in full screen
-More- 2/2	<b>More 2/2</b>	----	Select page 1/2

## Basic Operation

For example, we select CH1 as the source for FFT, select Rectangular window, set vertical scale to dBV RMS, and then we will get the FFT waveform like this. We can also measure the amplitude and frequency of the corresponding point with the manual cursors.

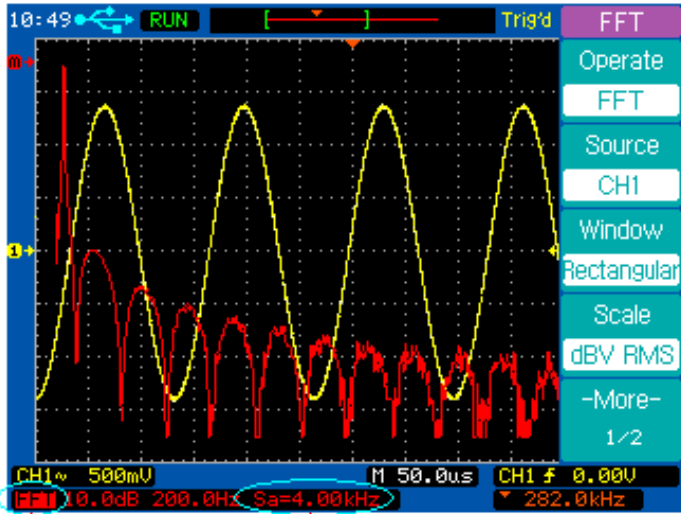

FFT Status

Sample Rate





FFT Spectrum Analysis

# Basic Operation

## REF Function

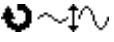
You might make measurement on a known good system, save the result to the internal memory or to an USB mass storage device, then make the same measurement on a test system and recall the reference waveform to see the difference.

Press **REF** channel key to turn on the **REF** menu page 1/2.

	Softkey	Options	Description
REF Source CH1	Source	CH1	Save CH1 as reference
		CH2	Save CH2 as reference
			REF vertical scale control
			REF vertical position control
Invert OFF	Invert	ON	REF invert ON
		OFF	REF invert OFF
-More- 1/2	More 1/2	----	Select page 2/2



## Basic Operation

Press softkey **More 1/2** to display **REF** menu page 2/2.

REF	Softkey	Options	Description
Internal Storage ↓	<b>Internal Storage</b>	INTERNAL menu	Save the reference waveform to the internal memory.
External Storage ↓	<b>External Storage</b>	EXTERNAL menu	Save the reference waveform to the USB mass storage device.
-More- 2/2	<b>More 2/2</b>	----	Select page 1/2

Press **REF** channel key to turn on the **REF** menu page 1/2 and load the latest saved reference waveform at the same time from the internal memory.

You can use the horizontal position and scale control knob to change the time base of the reference waveform.

Press  or  softkey and turn the Entry knob to change the vertical scale or position of the reference waveform.

## Basic Operation

Press **REF** → **Internal Storage** → **Save** to save the waveform of the Source channel as the reference waveform to the internal memory.

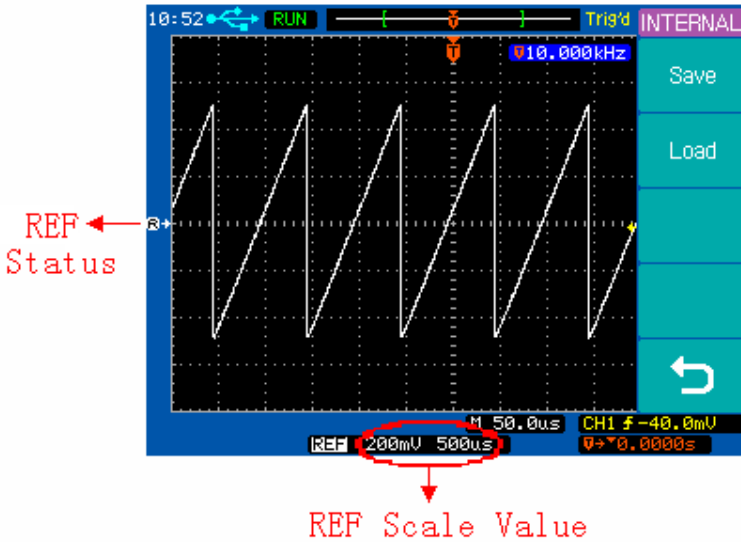

**Save a Reference waveform**

**Note: The reference waveform function is unavailable when X-Y mode is selected.**



## Basic Operation

---

### Horizontal Controls

Use the horizontal controls to adjust the time base, adjust the trigger location, and to examine waveform details more closely.

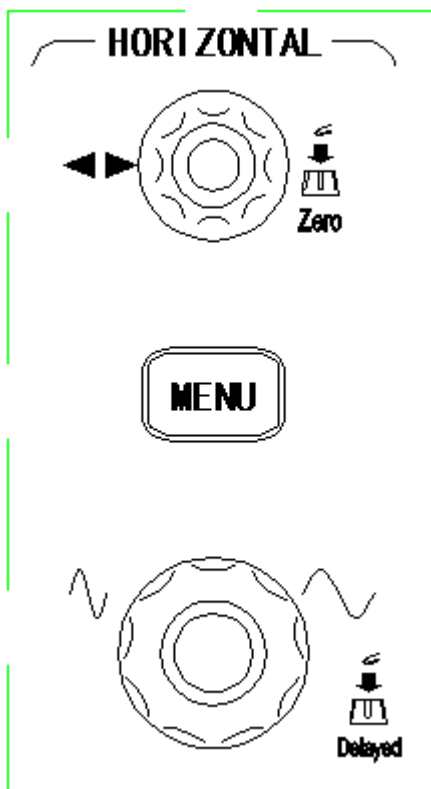

Horizontal Controls

## Basic Operation

---

### Horizontal Position Control

When the oscilloscope is running, this control lets you set the acquisition window relative to the trigger point. When the oscilloscope is stopped, you can turn this knob to pan through the data horizontally. This lets you see the captured waveform before the trigger or after the trigger.

The trigger position is marked with the letter “T” at the top of the graticule and also in the waveform record icon at the top of the screen.

The small inverted triangle is the time reference indicator. When you change the horizontal scale, the waveforms contract or expand about this point.

Press the horizontal position control knob to set the time delay to zero, and the trigger position indicator (🔍) overlays the time reference indicator(▼).

***Note: The horizontal position control is unavailable when X-Y horizontal mode is selected.***

### Horizontal Scale Control

Use the horizontal scale control to adjust the time base. The scale expands or contracts around the center of the screen. The horizontal scale factor can be set in a 1-2.5-5 sequence (for A series) or in a 1-2-5 sequence (for B series).

# Basic Operation

---

Press the horizontal scale control knob to toggle between Main and Delayed horizontal mode.

## Horizontal **MENU** key

Press the horizontal **MENU** key to display the **HORIZONTAL** menu. This menu lets you select the horizontal mode: **Main**, **Delayed**, **Roll**, or **X-Y**, and set the **Holdoff** time.

Press the horizontal **MENU** key to display the **HORIZONTAL** menu page 1/2.

HORIZONTAL	Softkey	Options	Description
Main ✓	<b>Main</b>	√	Main mode is ON
		----	Main mode is OFF
Delayed	<b>Delayed</b>	√	Delayed mode is ON
		----	Delayed mode is OFF
X-Y	<b>X-Y</b>	√	X-Y mode is ON
		----	X-Y mode is OFF
Roll	<b>Roll</b>	√	Roll mode is ON
		----	Roll mode is OFF
-More- 1/2	<b>-More- 1/2</b>	----	Select page 2/2

## Basic Operation

---

Press softkey **More 1/2** to display the **HORIZONTAL** menu page 2/2.

HORIZONTAL	Softkey	Options	Description
Holdoff 100ns Holdoff Reset	<b>Holdoff</b>	↻	Set up the holdoff time between two triggers.
Trig-Offset Reset	<b>Holdoff</b> <b>Reset</b>	----	Reset the holdoff time to default value 100ns.
-More- 2/2	<b>Trig-Offset</b> <b>Reset</b>	----	Reset the delay time to zero.
	<b>-More-</b> <b>2/2</b>	----	Select page 1/2

### Main Horizontal Mode

Main horizontal mode is the normal viewing mode for the oscilloscope. When the oscilloscope is stopped, you can use the horizontal controls to pan and zoom the waveform. When the oscilloscope is running in Main mode, use the horizontal scale knob to change horizontal scale factor and use the horizontal position knob to set the delay time. When the oscilloscope is stopped, use the horizontal control knobs to pan and zoom the waveform. The time base (second/division) value is displayed at the bottom of the screen.

## Basic Operation

Press the horizontal **MENU** key and then press the **Main** softkey to select the main horizontal mode.

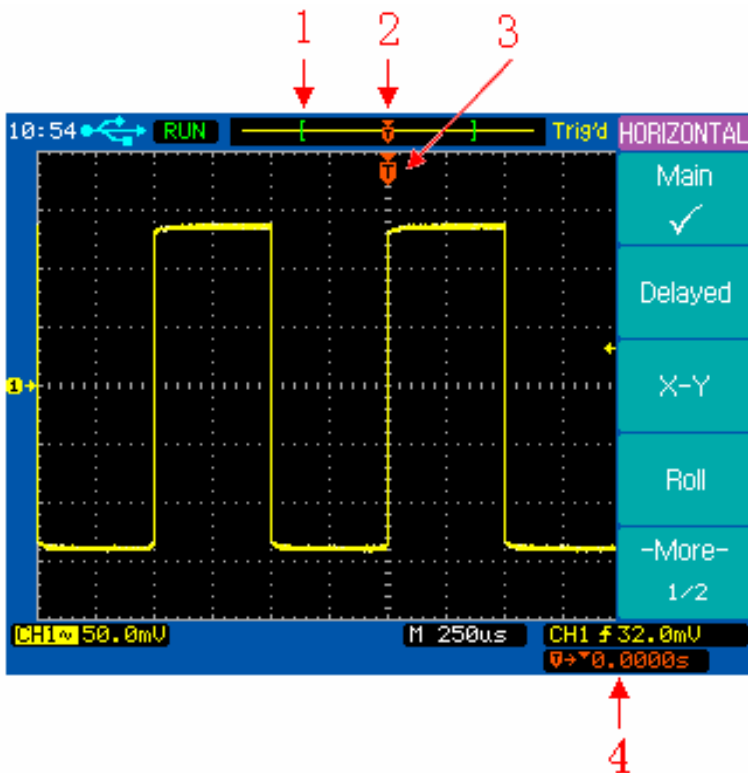

### Main Horizontal Mode

1. The square brackets show the location of current display window within the record.
2. Trigger position within the record.
3. Trigger position on the current waveform display window.
4. Readout shows the delay time or the trigger location within the record relative to the time reference point ( $\blacktriangledown$ ).

## Basic Operation

---

### Delayed Horizontal Mode

Delayed horizontal mode is an expanded version of main mode. When Delayed mode is selected, the display divides in half. The top half of the display shows the normal waveform and bottom half displays the delayed waveform.

Delayed waveform is a magnified portion of the normal waveform. You can use delayed waveform to locate and horizontally expand part of the normal waveform for a more detailed analysis of signals.

The area of the normal display that is expanded is marked on each end with a vertical shadow area. The unshadowed area shows what portion of the normal waveform is expanded in the lower half.

To change the time base for the delayed window, turn the horizontal scale knob. As you turn the knob, the time base for the delayed window is displayed just above the main time base.

To change the time base for the normal window, press the Main softkey, then turn the horizontal scale control knob.

Connect a triangle signal source to CH1, press the horizontal **MENU** key and then press the **Delayed** softkey to enter the Delayed mode. You can also press the horizontal scale

## Basic Operation

control knob to toggle between Main and Delayed mode directly.

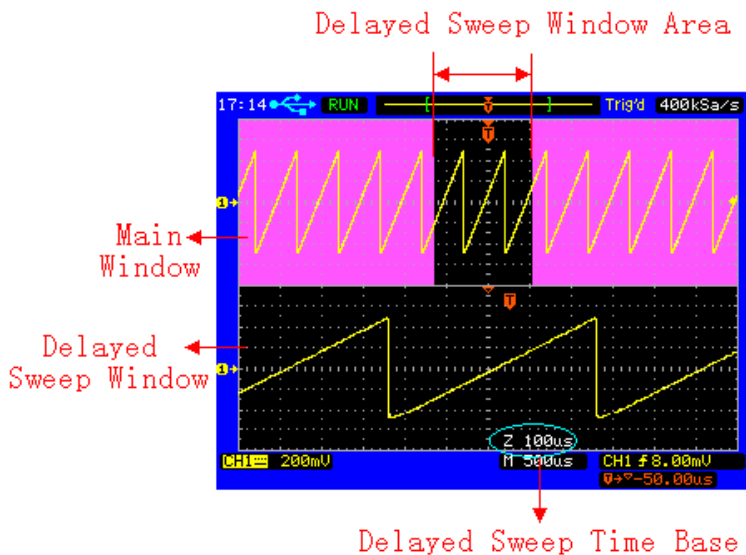

### Delayed Horizontal Mode

## Basic Operation

---

### **X-Y Horizontal Mode**

X-Y mode changes the display from a volts-versus-time display to a volts-versus-volts display. The time base is turned off. CH1 amplitude is plotted on the X axis and CH2 amplitude is plotted on the Y axis.

You can use X-Y mode to compare frequency and phase relationships between two signals. X-Y mode can also be used with transducers to display strain versus displacement, flow versus pressure, volts versus current, or voltage versus frequency.

In order to get a better view of the waveform, proper vertical scale should be selected before enter the X-Y mode.

Use X-Y mode to compare two signal with same frequency and different phase. Connect the two signal to CH1 and CH2 respectively. Press horizontal **MENU** key and then **X-Y** softkey to select X-Y mode.



## Basic Operation

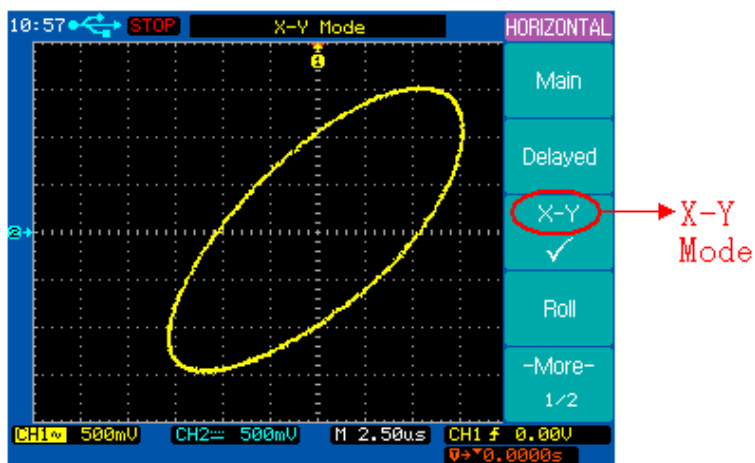

**X-Y Horizontal Mode**

## Basic Operation

---

### Roll Horizontal Mode

Roll mode causes the waveform to move slowly across the screen from right to left. It only operates on time base settings of 500 ms/div or slower. If the current time base setting is faster than the 500 ms/div limit, it will be set to 500ms/div when Roll mode is selected.

In Roll mode there is no trigger. The fixed reference point on the screen is the right edge of the screen and refers to the current moment in time. Events that have occurred are scrolled to the left of the reference point. Since there is no trigger, no pre-trigger information is available.

If you would like to pause the display in Roll mode, press the **SINGLE** key. To clear the display and restart an acquisition in Roll mode, press the **SINGLE** key again.

Use Roll mode on low-frequency waveforms to yield a display much like a strip chart recorder. It allows the waveform to roll across the display.

Press the horizontal **MENU** key and then press the **Roll** softkey to select the Roll mode. The waveform moves slowly across the screen from right to left. The fastest time base is 500 ms.

## Basic Operation

---

Roll Status

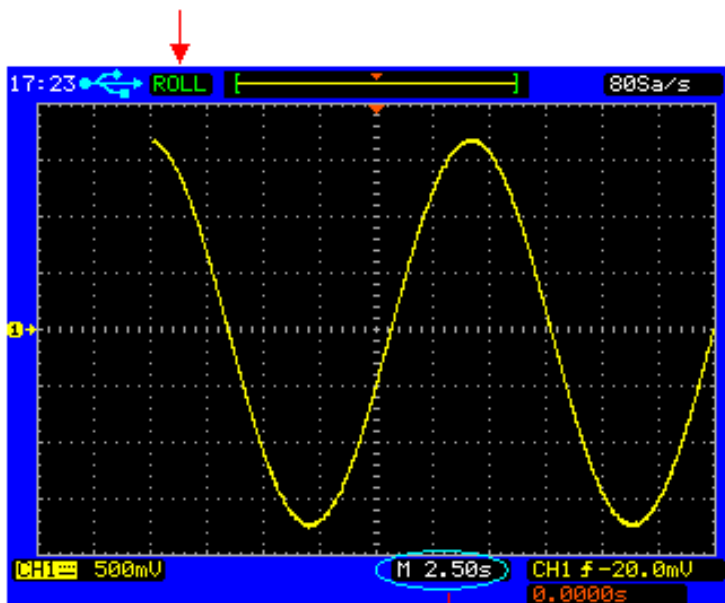

Horizontal Time Base

Roll Horizontal Mode

## Basic Operation

---

### **Holdoff Function**

Holdoff sets the amount of time that the oscilloscope will wait before rearming the trigger circuit. You can use the holdoff function to stabilize the display of complex waveforms.

With the holdoff function, you can synchronize triggers. The oscilloscope will trigger on one edge of the waveform, and ignore further edges until the holdoff time is up. The oscilloscope will then rearm the trigger circuit to wait for the next edge trigger. This allows the oscilloscope to trigger on a repeating pattern in a waveform.

Turn the Entry knob to increase or decrease the trigger hold off time shown in the Holdoff softkey.

To get a stable trigger on the pulse burst shown on the screen, set the holdoff time to be slightly less than the period of the pulse burst.

## Basic Operation

Trigger Position

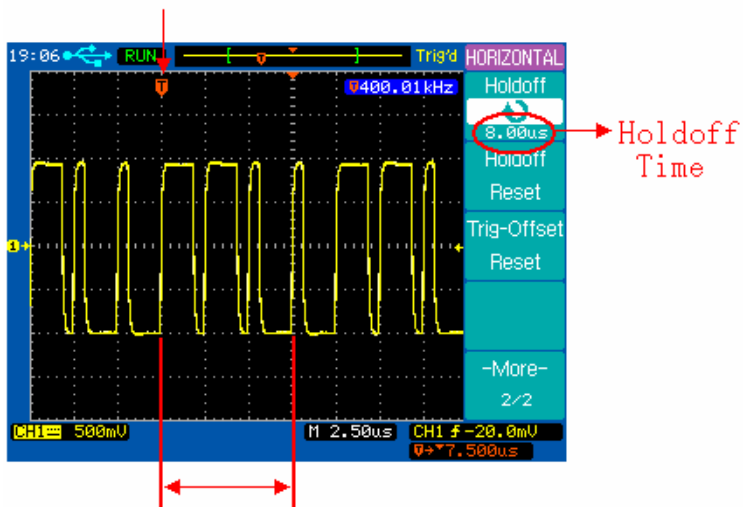

Holdoff Time  
(Pulse Width)

**Holdoff Function**

# Basic Operation

---

## Trigger Controls

The trigger controls determine when the oscilloscope starts to acquire and display the waveform. When a trigger is found, the oscilloscope will acquire sufficient data to display the waveform. Trigger controls are functional when the oscilloscope works under Main or Delayed horizontal mode.

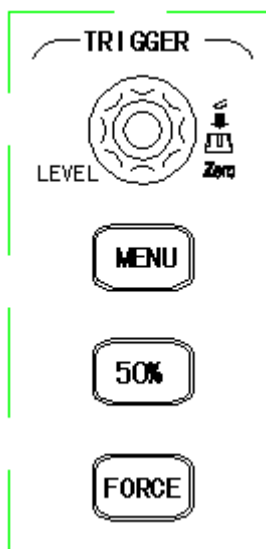

**Trigger Controls**

# Basic Operation

---

## Trigger Control **MENU** key

Press the trigger control **MENU** key to show the **TRIGGER** menu and then press the **Type** softkey to select Edge, Pulse or Video.

## Set to 50% key

Press the **50%** key to set the trigger level to the 50% amplitude level of the trigger source waveform.

## Force Trigger key

Press the **FORCE** key to force an immediate trigger event, even in the absence of a signal. This function is useful in following situations.

If you do not see a waveform on the screen when using Normal trigger mode, press the **FORCE** key to acquire the signal baseline to verify that it is on the screen.

After you press the **SINGLE** key to set up for a single shot acquisition, you can press the **FORCE** key to do a practise acquisition to verify the control settings.

## Trigger Level Control

Use the trigger level control knob to adjust the trigger level. When you change the trigger level, a horizontal line temporarily appears to show you the level on screen. After

## Basic Operation

---

the line disappears, the trigger level is marked with a small left arrow.

### Auto and Normal Trigger Modes

Press the trigger **MENU** key to display the **TRIGGER** menu and press the **Mode** softkey to select Auto or Normal trigger mode.

**Note: The Auto and Normal trigger mode is unavailable when Video trigger type is selected.**

### Auto mode

Use the auto trigger mode for signals other than low-repetitive-rate signals and for unknown signal levels. To display a DC signal, you must use Auto trigger mode since there is no edge to trigger on.

When you press **RUN/STOP** key to start acquiring, the oscilloscope first fill the pre-trigger buffer. It starts to search for a trigger after the pre-trigger buffer is filled, and continues to flow data through this buffer while it searches for the trigger. While searching for the trigger, the oscilloscope overflows the pre-trigger buffer; the first data put into the buffer is the first pushed out. When a trigger is found, the pre-trigger buffer will contain the events that occurred just before the trigger. If no trigger is found, the oscilloscope generates a trigger and displays the data as though a trigger had occurred. In this



## Basic Operation

---

case, the background of the Auto indicator at the top of the display will flash, indicating that the oscilloscope is force triggered.

When you press the **SINGLE** key, the oscilloscope will fill the pre-trigger buffer, and continue to flow data through the pre-trigger buffer until the Auto trigger overrides the searching and forces a trigger. At the end of the trace, the oscilloscope will stop and display the results.

### **Normal mode**

Use Normal trigger mode for low repetitive-rate signals or when Auto trigger is not required.

In Normal mode the oscilloscope must fill the pre-trigger buffer with data before it will begin searching for a trigger event. While searching for the trigger, the oscilloscope overflows the pre-trigger buffer; the first data put into the buffer is the first pushed out.

When the trigger event is found, the oscilloscope will fill the post-trigger buffer and display the results. If the acquisition was initiated by **RUN/STOP**, the process repeats. If the acquisition was initiated by **SINGLE**, then the acquisition stops.

## Basic Operation

---

In either Auto or Normal mode, the trigger may be missed. This is because the oscilloscope will not recognize a trigger event until the pre-trigger buffer is full.

# Basic Operation

---

## **Video Trigger**

Choose video triggering to trigger on the odd fields, even fields, or on all the lines of a NTSC, PAL/SECAM video signal.

## Basic Operation

Press trigger control **MENU** key to display the **TRIGGER** menu, then press **Type** softkey to select Video trigger.

TRIGGER	Softkey	Options	Description
Type	<b>Type</b>	Video	Video triggering
Video		Edge	Edge triggering
Source		Pulse	Pulse width triggering
CH1	<b>Source</b>	CH1	Trigger on CH1
Polarity		CH2	Trigger on CH2
Sync		EXT	Trigger on EXT
Line # No. 13		EXT/5	Trigger on EXT/5
Standard PAL/SECAM		Alternating	Trigger on CH1 and CH2 alternately
<b>Polarity</b>	⌋	Positive polarity	
	⌋	Negative polarity	
<b>Sync</b>	Odd Field	Trigger on odd fields	
	Even Field	Trigger on even fields	
	All Lines	Trigger on all lines	
	Line #	Trigger on specific line.	
<b>Standard</b>	NTSC	Trigger on NTSC signal	
	PAL/SECAM	Trigger on PAL or SECAM signal	

## Basic Operation

Following figures show the video waveforms triggered on odd fields and specific line 6.

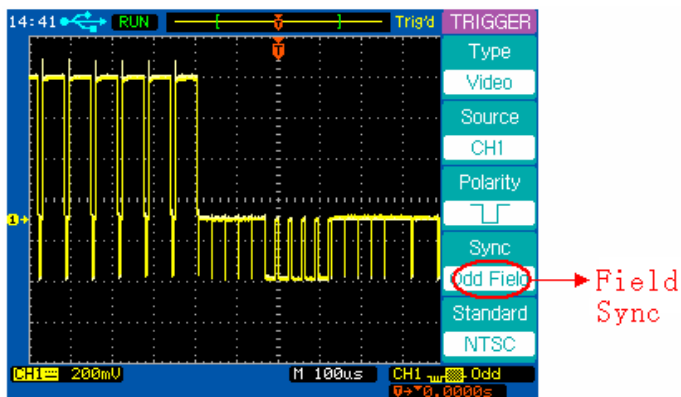

Trigger on odd fields

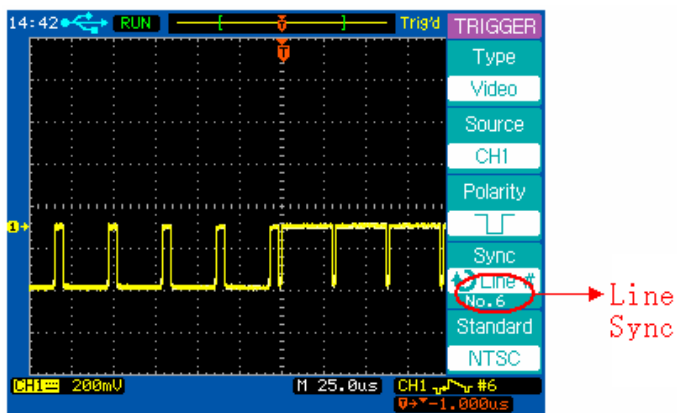

Trigger on specific line 6

**Note:** The trigger level control is unavailable when Video type is selected.

## Basic Operation

---

### Edge Trigger

Use the Edge triggering to trigger on the rising or falling edge of the input signal at the trigger threshold.

## Basic Operation

---

Press trigger control **MENU** key to display the **TRIGGER** menu, then press **Type** softkey to select Edge trigger.

TRIGGER	Softkey	Options	Description
Type	<b>Type</b>	Video	Video triggering
Edge		Edge	Edge triggering
Source		Pulse	Pulse width triggering
CH1	<b>Source</b>	CH1	Trigger on CH1
Slope		CH2	Trigger on CH2
↕		EXT	Trigger on EXT
Mode		EXT/5	Trigger on EXT/5
Auto		AC Line	Trigger on AC line signal
Coupling		Alternating	Trigger on CH1 and CH2 alternately
DC	<b>Slope</b>	↕	Rising edge of a signal
		↘	Falling edge of a signal
DC	<b>Mode</b>	Auto	Trigger even without a valid event.
		Normal	Trigger only on a valid event
DC	<b>Coupling</b>	AC	AC coupling
		DC	DC coupling
		LF Reject	Reject low frequencies
		HF Reject	Reject high frequencies

## Basic Operation

---











### **Pulse Width Trigger**

Pulse width triggering sets the oscilloscope to trigger on a positive or negative pulse of a specified width from 20ns to 10s.



## Basic Operation

Press trigger control **MENU** key to display the **TRIGGER** menu, then press **Type** softkey to select Pulse trigger.

TRIGGER	Softkey	Options	Description
Type	<b>Type</b>	Video	Video triggering
Pulse		Edge	Edge triggering
Source		Pulse	Pulse width triggering
CH1	<b>Source</b>	CH1	Trigger on CH1
Pulse Mode		CH2	Trigger on CH2
		EXT	Trigger on EXT
Pulse Setup		EXT/5	Trigger on EXT/5
1.000us		Alternating	CH1 and CH2 alternately
-More-	<b>Pulse Mode</b>		Positive greater than
1/2			Positive equal
			Positive within
			Positive less than
			Negative greater than
			Negative equal
			Negative within
			Negative less than
<b>Pulse Setup</b>	<b>Pulse Setup</b>		Set the pulse width
<b>More 1/2</b>	<b>More 1/2</b>	----	Select page 2/2

## Basic Operation

---

Press trigger control **MENU** key to display the **TRIGGER** menu, press **Type** softkey to select Pulse trigger and then press the **More 1/2** softkey to display **TRIGGER** menu page 2/2.

TRIGGER	Softkey	Options	Description
Type	<b>Type</b>	Video	Video triggering
Pulse		Edge	Edge triggering
Mode		Pulse	Pulse width triggering
Auto	<b>Mode</b>	Auto	Trigger even without a valid event.
Coupling		Normal	Trigger only on a valid event
DC	<b>Coupling</b>	AC	AC coupling
-More-		DC	DC coupling
2/2		LF Reject	Reject low frequencies
		HF Reject	Reject high frequencies
	<b>More 2/2</b>	----	Select page 1/2

**Note: EXT(50Ω) trigger source option is available only for model TDO1202B and TDO2202B.**

## Basic Operation

---

### ACQUIRE Menu

Press the **ACQUIRE** menu key to show the **ACQUIRE** menu.

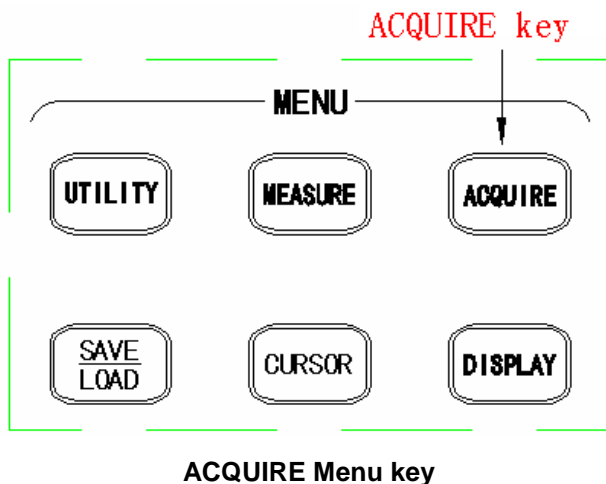

**Normal** acquisition mode yields the best display for most waveforms.

**Average** mode lets you average multiple triggers to reduce noise and increase resolution.

**Peak Detect** mode should be used to display narrow pulses that occur infrequently. It's useful when looking for very narrow pulses at very slow time base.

**Equivalent** sampling mode is useful to display high frequency repetitive signals.

## Basic Operation

---

**Real Time** sampling mode is useful to capture the single-shot signals.

Press **Mode** softkey to select **Normal** mode.

ACQUIRE	<b>Softkey</b>	<b>Options</b>	<b>Description</b>
Mode	<b>Mode</b>	Normal	Normal acquisition.
Normal		Average	Average acquisition.
		Peak Detect	Peak detect acquisition
Sampling	<b>Sampling</b>	Equivalent	Equivalent sampling.
Equivalent		Real Time	Real time sampling.
Record	<b>Record</b>	----	Select Record menu

## Basic Operation

Press **Mode** softkey to select **Average** mode.



Softkey	Options	Description
<b>Mode</b>	Normal	Normal acquisition.
	Average	Average acquisition.
	Peak Detect	Peak detect acquisition
<b>Averages</b>	↻	Set the average number to 2, 4, 8, 16, 32, 64, 128, or 256.
<b>Sampling</b>	Equivalent	Equivalent sampling.
	Real Time	Real time sampling.
<b>Record</b>	----	Select Record menu

Press **Mode** softkey to select **Peak Detect** mode.



Softkey	Options	Description
<b>Mode</b>	Normal	Normal acquisition.
	Average	Average acquisition.
	Peak Detect	Peak detect acquisition
<b>Sampling</b>	Equivalent	Equivalent sampling.
	Real Time	Real time sampling.
<b>Record</b>	----	Select Record menu

## Basic Operation

Connect a sine signal to the CH1 channel, press **ACQUIRE** → **Mode** to select Average mode. Turn the Entry knob to set the number of averages to 16. The following two figures show the difference between Normal acquisition and Average acquisition.

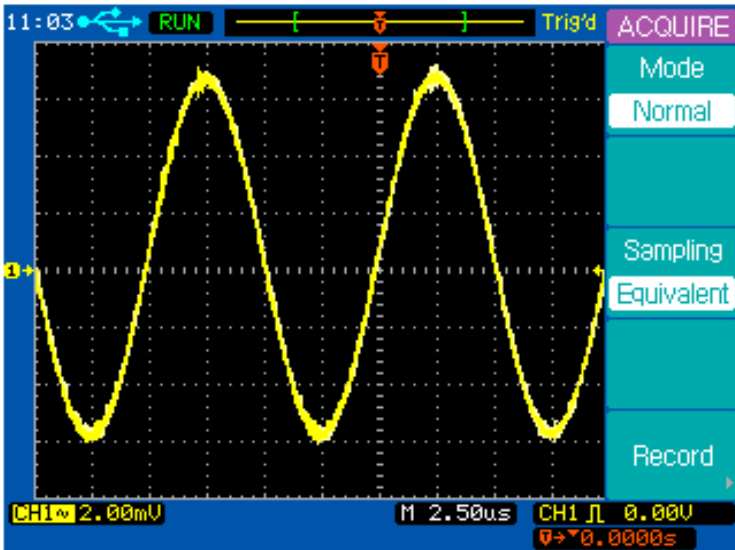

Random noise on the displayed waveform

## Basic Operation

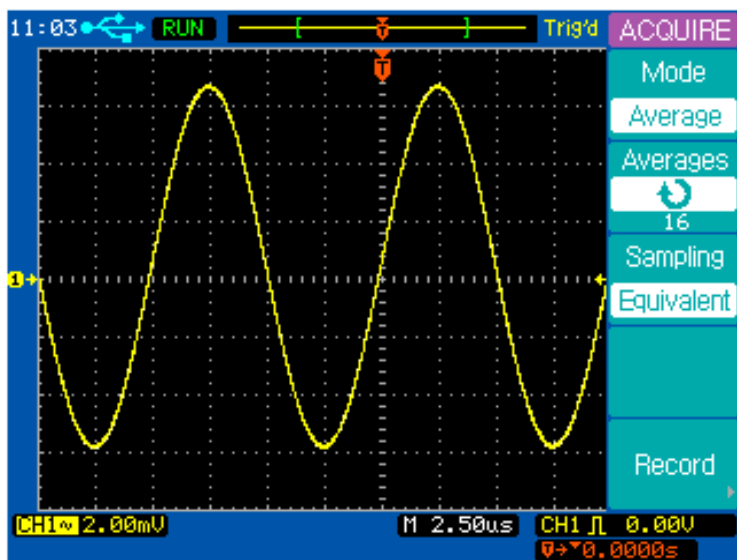

16 Averages used to reduce random noise

# Basic Operation

## Record the Waveform

Press **ACQUIRE** → **Record** to show the **RECORD** menu.

	<b>Softkey</b>	<b>Options</b>	<b>Description</b>
	<b>Mode</b>	Record	Record the waveform
		Play Back	Play back the record
		Save /Recall	Save/Recall from internal or external memory.
		OFF	Exit Record function
	<b>Source</b>	CH1	Record CH1 channel
		CH2	Record CH2 channel
		Pass/Fail Out	Record Pass/Fail output waveform
	<b>Interval</b>	↻	Set the time interval
	<b>End Frame</b>	↻	Maximum record frame
<b>Operate</b>	●	Record	
	■	Stop	



# Basic Operation

## Play Back the Record

Press **ACQUIRE** → **Record** to show the **RECORD** menu.

Press **Mode** softkey to select Play Back function.

RECORD	Softkey	Options	Description
Mode	<b>Mode</b>	Record	Record the waveform
Play back		Play Back	Play back the record
Operate		Save /Recall	Save/Recall from internal or external memory.
Play Mode		OFF	Exit Record function
Current Frame		▶	Play
1	<b>Operate</b>	■	Stop
-More- 1/2		↺↻	Loop play
1	<b>Play Mode</b>	▶→■	Single play
Current Frame	<b>Current Frame</b>	↺	Select a specific frame
1	<b>More</b> 1/2	----	Select menu page 2/2

## Basic Operation

---

Press **ACQUIRE** → **Record** to show the **RECORD** menu.  
 Press **Mode** softkey to select Play Back function. Press **More** **1/2** softkey to show **RECORD** menu page 2/2.

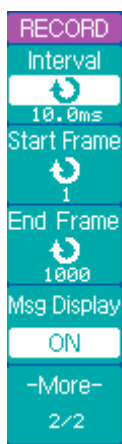

Softkey	Options	Description
<b>Interval</b>	↻	Interval between two frames
<b>Start Frame</b>	↻	Set the start frame to playback.
<b>End Frame</b>	↻	Set the end frame to playback.
<b>Msg Display</b>	ON	Record message on
	OFF	Record message off
<b>More 2/2</b>	----	Select menu page 1/2

**Note:** *The interval time must be greater than 1ms + signal period + sampling interval time + frame storage time .*

**Note:** *Frame length is the waveform storage depth. Maximum 1000 frames of waveform can be stored.*

## Basic Operation

### Save/Recall the Record

Press **ACQUIRE** → **Record** to show the **RECORD** menu.

Press **Mode** softkey to select **Save/Recall** function.





Softkey	Options	Description
<b>Mode</b>	Record	Record the waveform
	Play back	Play back the record
	Save /Recall	Save/Recall from internal or external memory.
	OFF	Exit Record function
<b>Start Frame</b>	↻	Set the start frame to playback.
<b>End Frame</b>	↻	Set the end frame to playback.
<b>Internal Storage</b>	----	Save/Recall from internal memory.
<b>External Storage</b>	----	Save/Recall from external memory.

## Basic Operation

---

### Exit Record Function

Press **Mode** softkey to select **OFF** option and return to the **ACQUIRE** menu.

RECORD	Softkey	Options	Description
Mode	<b>Mode</b>	Record	Record the waveform
OFF		Play back	Play back the record
		Save /Recall	Save/Recall from internal or external memory.
		OFF	Exit Record function
		----	Return to ACQUIRE menu

## Basic Operation

---

### UTILITY Menu

Press the **UTILITY** menu key to show the **UTILITY** menu.

UTILITY key

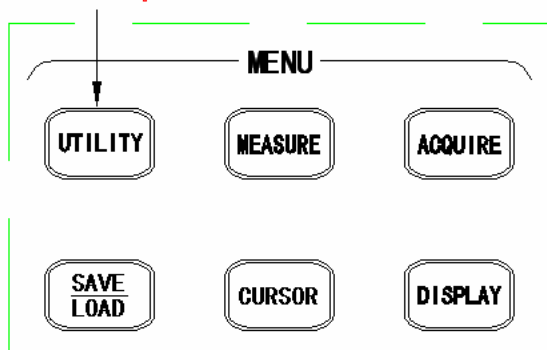

UTILITY Menu key

## Basic Operation

---

Press the **UTILITY** key to display the **UTILITY** menu page 1/2.

UTILITY	Softkey	Options	Description
I/O Setup ▶	<b>I/O Setup</b>	----	Select <b>I/O SETUP</b> menu
Print Setup ▶	<b>Print Setup</b>	----	Select <b>PRINT</b> menu
System Setup ▶	<b>System Setup</b>	----	Select <b>SYETEM</b> menu
Language	<b>Language</b>	English	English language
English		简体中文	Simplified Chinese
-More- 1/2		繁體中文	Traditional Chinese
		한국어	Korean language
		日本語	Japanese language
<b>More 1/2</b>	----	Select menu page 2/2	

## Basic Operation

---

Press the **More 1/2** softkey to display the **UTILITY** menu page 2/2.

UTILITY	Softkey	Options	Description
Service ▶	<b>Service</b>	----	Select <b>Service</b> menu
Pass/Fail ▶	<b>Pass/Fail</b>	----	Select <b>PASS/FAIL</b> menu
Self-Cal	<b>Self-Cal</b>	<b>RUN/STOP</b>	Start self-calibration
		<b>AUTO</b>	Exit self-calibration.
Self-Cal	<b>More 2/2</b>	----	Select menu page 1/2
-More- 2/2			

## Basic Operation

---

### I/O Setup

Press **UTILITY** → **I/O Setup** to display the **I/O SETUP** menu.

I/O SETUP	Softkey	Options	Description
Type	Type	USB Slave	Select USB
USB Slave		RS232C	Select RS232C
		GPIB	Select GPIB
	↶	----	Return to the UTILITY menu
↶			

**Note:** *RS232C or GPIB will be available, only when the optional expanded communication module is fixed.*





# Basic Operation

## Print Setup

Press **UTILITY** → **Print Setup** to display the **PRINT** menu.

Press **Print to** softkey to select File.



Softkey	Options	Description
<b>Print to</b>	USB Printer	Print to USB printer
	File	Print to file
<b>File Type</b>	BMP	BMP file format
	CSV	CSV file format
	----	Return to the UTILITY menu

Connect an USB mass storage device to the USB host connector on the front panel.

Press **Print to** softkey to select File.

Press **File Type** softkey to select the file format you want.



Press the **PRINT** key to save the file to the USB mass storage device.

## Basic Operation

---

Press **UTILITY** → **Print Setup** to display the **PRINT** menu.

Press **Print to** softkey to select USB Printer.

<b>PRINT</b>	<b>Softkey</b>	<b>Options</b>	<b>Description</b>
Print to	<b>Print to</b>	USB Printer	Print to USB printer
USB Printer		File	Print to file
Palette	<b>Palette</b>	Color	Print screen display as a color picture
Color		Gray Scale	Print screen display as a gray scale picture
Ink Saver	<b>Ink Saver</b>	ON	Ink saver on
ON		OFF	Ink saver off
		----	Return to the <b>UTILITY</b> menu

Connect an USB Printer to the USB host connector on the rear panel.

Press **Print to** softkey to select USB Printer.

Press **Palette** softkey to select Color or Gray Scale.

Press **Ink Saver** softkey to turn on/off ink saver.

Press the **PRINT** key to print the screen display to the USB printer.

**Note:** For TDO1000 series, the **Palette** and **Ink Saver** functions are not available. The TDO1000 and TDO2000 series only support USB printers that use PCL 3 printer command language.

## Basic Operation

---

Supported USB Printers are as follows:

**HP DeskJet 5438**

**HP DeskJet 3820**

# Basic Operation

## System Setup

Press **UTILITY** → **System Setup** to display the **SYSTEM** menu.



Softkey	Options	Description
<b>Key</b>		Key press sound on
<b>Sound</b>		Key press sound off
<b>Alarm</b>		Alarm sound on
<b>Sound</b>		Alarm sound off
<b>Counter</b>	ON	Frequency counter on
	OFF	Frequency counter off
<b>Set Date &amp; Time</b>	----	Select the DATE&TIME menu
	----	Return to the <b>UTILITY</b> menu

**Note: For model TDO1022A and TDO1042AE, Set Date&Time function is not available.**

## Basic Operation

---



Press the **Set Date&Time** softkey to display the **DATE&TIME** menu.

<b>DATE&amp;TIME</b>	<b>Softkey</b>	<b>Options</b>	<b>Description</b>
 <p>The screenshot shows a vertical menu titled 'DATE&amp;TIME'. The first option is 'Display' with 'ON' selected. Below are 'Hour' (9) and 'Min' (42), 'Month' (4) and 'Day' (28), and 'Year' (2007). At the bottom is 'OK! Enter'.</p>	<b>Display</b>	ON	Date & time display on
		OFF	Date & time display off
	<b>Hour</b>	↻	Set hour
	<b>Min</b>	↻	Set minute
	<b>Month</b>	↻	Set month
	<b>Day</b>	↻	Set day
	<b>Year</b>	↻	Set year
	<b>OK! Enter</b>	----	Apply the time and date

# Basic Operation

## Service

Press **UTILITY** → **Service** to display the **Service** menu.

<b>SERVICE</b>	<b>Softkey</b>	<b>Options</b>	<b>Description</b>
System Info	<b>System Information</b>	----	Display system information: Model, Serial number, Software version, Installed modules.
Screen Test	<b>Screen Test</b>	----	Test the LCD screen
Key Test	<b>Key Test</b>	----	Check the key and control operation.
		----	Return to the <b>UTILITY</b> menu

## Basic Operation

Press **UTILITY** → **Service** to display the **Service** menu, and then press the **System Info** softkey to display the system informations, such as Model, Serial number, Power up times, Software version and a list of installed modules.

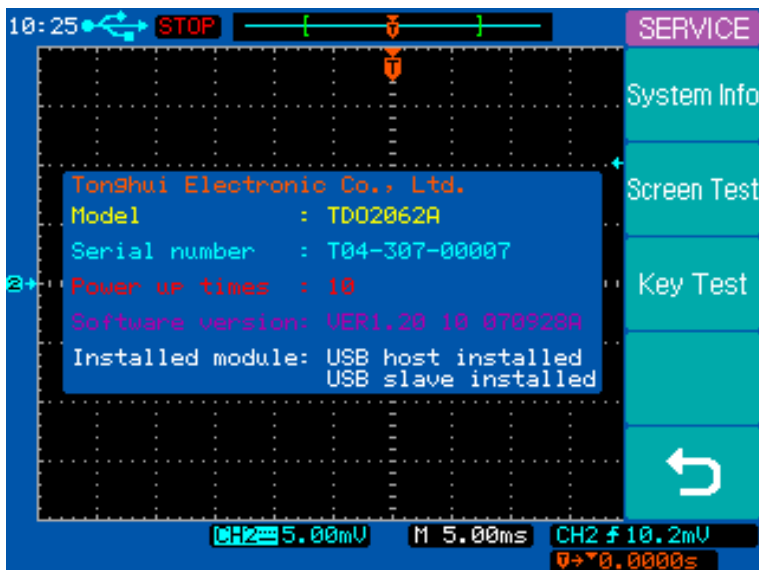

### System Information

## Basic Operation

### Pass/Fail

The oscilloscope first measures the input source signal and compares it with Pass/Fail regulations and then outputs the Pass/Fail result.

Press **UTILITY** → **Pass/Fail** to display the **PASS/FAIL** menu 1/2.

	Softkey	Options	Description
PASS/FAIL Enable Test OFF Source CH1 Operate Setup Mask -More- 1/2	Enable Test	ON	Pass/Fail function on
		OFF	Pass/Fail function off
	Source	CH1	Source signal CH1
		CH2	Source signal CH2
	Operate	▶	Start Pass/Fail test
		■	Stop Pass/Fail test
	Setup Mask	----	Set up the regulations
	More 1/2	----	Display the menu 2/2



## Basic Operation

---

Press **More 1/2** to display the **PASS/FAIL** menu 2/2.



Softkey	Options	Description
<b>Msg Display</b>	ON	Pass/Fail function on
	OFF	Pass/Fail function off
<b>Output</b>	PASS	Output on Pass waveforms
	PASS+	Output and alarm on Pass waveforms
	FAIL	Output on Fail waveforms
	FAIL+	Output and alarm on Fail waveforms
<b>Stop on Output</b>	ON	Stop sampling on output
	OFF	Continue sampling on output
	----	Return to the <b>UTILITY</b> menu
<b>More 2/2</b>	----	Display the menu page 1/2

**Note: Pass/Fail function is not available when X-Y mode is selected.**

## Basic Operation

---

Press **UTILITY** → **Pass/Fail** → **Setup Mask** to display the **MASK** menu 1/2.

MASK	<b>Softkey</b>	<b>Options</b>	<b>Description</b>
X Mask 0.40div	<b>X Mask</b>	↶	Set horizontal tolerance
Y Mask 0.40div	<b>Y Mask</b>	↷	Set vertical tolerance.
Create Mask	<b>Create Mask</b>	----	Create the PASS/FAIL tolerance mask.
↶	↶	----	Return to the <b>PASS/FAIL</b> menu
-More- 1/2	<b>More 1/2</b>	----	Display the menu 2/2

## Basic Operation

---

Press **More 1/2** to display the **MASK** menu 2/2.

MASK	Softkey	Options	Description
Internal Storage ▾	<b>Internal Storage</b>	----	Store the PASS/FAIL tolerance mask to internal memory.
External Storage ▾	<b>External Storage</b>	----	Store the PASS/FAIL tolerance mask to external USB mass storage device.
↶	↶	----	Return to the <b>PASS/FAIL</b> menu
-More- 2/2	<b>More 2/2</b>	----	Display the menu page 1/2

## Basic Operation

---

### Self-Calibration

If you want to maximize the measurement accuracy, you can perform the self-calibration.

Self-calibration uses the internally generated signals to optimize circuits that affect channel scale, offset and trigger parameters. Disconnect all inputs and allow the oscilloscope to warm up at least 30 minutes before performing this self-calibration.

Press **UTILITY** → **Self-Cal** to display the self-calibration page. Press **AUTO** key to exit the Self-Calibration, press **RUN** key to start the self-calibration.

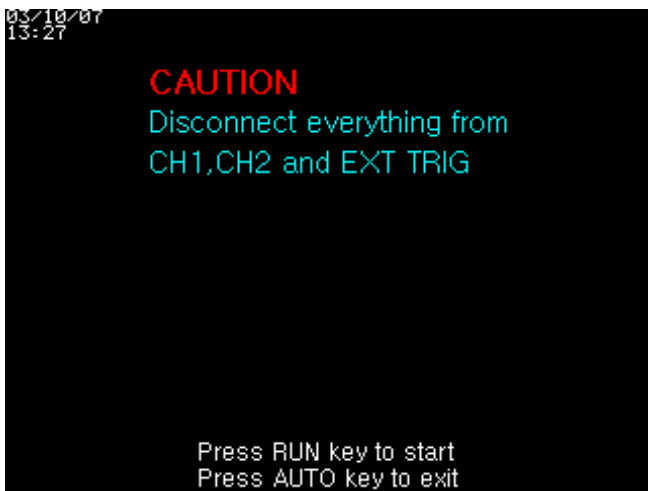

### Self Calibration

**Note: Warm up the oscilloscope at least 30 minutes before performing self-calibration.**

## Basic Operation

---

### MEASURE Menu

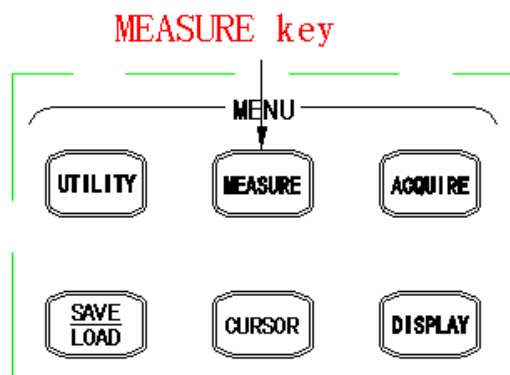

MEASURE Menu key

## Basic Operation

---

Press **MEASURE** menu key to display the **MEASURE** menu.

<b>MEASURE</b>
Source
CH1
Voltage
Time
Clear
Measure All
ON

Softkey	Options	Description
<b>Source</b>	CH1	Measure CH1
	CH2	Measure CH2
<b>Voltage</b>	----	Select the Voltage measurement menu.
<b>Time</b>	----	Select the Time measurement menu
<b>Clear</b>	----	Turn off the current measurement readouts
<b>Measure All</b>	ON	Display all measurements
	OFF	Close all measurements

# Basic Operation

## Voltage Measurements

Press **MEASURE** → **Voltage** to display the **VOLTAGE** menu page 1/4.

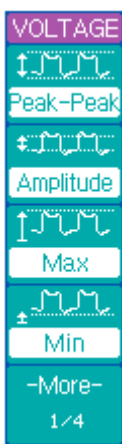





Softkey	Options	Description
<b>Peak-Peak</b>	----	The Peak-Peak value is the difference between maximum and minimum values.
<b>Amplitude</b>	----	The Amplitude value is the difference between its High and Low values.
<b>Max</b>	----	Max is the highest value in the waveform display.
<b>Min</b>	----	Min is the lowest value in the waveform display.
<b>More 1/4</b>	----	Display menu page 2/4

## Basic Operation

---





Press **More 1/4** softkey to display the **VOLTAGE** menu page 2/4.

VOLTAGE	Softkey	Options	Description
 High	<b>High</b>	----	High value is the mode (most common value) of the upper part of the waveform.
 Low	<b>Low</b>	----	Low value is the mode (most common value) of the lower part of the waveform.
 Average	<b>Average</b>	----	Average value is the sum of the samples divided by the number of samples over the entire waveform.
 RMS	<b>RMS</b>	----	RMS value is the true Root Mean Square voltage over the entire waveform.
-More- 2/4	<b>More 2/4</b>	----	Display menu page 3/4



## Basic Operation

Press **More 2/4** softkey to display the **VOLTAGE** menu page 3/4.

VOLTAGE	Softkey	Options	Description
 Cycle Avg	<b>Cycle Avg</b>	----	Cycle Avg value is the sum of the samples divided by the number of samples over one period.
 Cycle RMS	<b>Cycle RMS</b>	----	Cycle RMS value is the true Root Mean Square voltage over one period.
 Overshoot	<b>Overshoot</b>	----	Overshoot value is distortion that follows a major edge transition expressed as a percentage of amplitude.
 Preshoot	<b>Preshoot</b>	----	Preshoot value is distortion that precedes a major edge transition expressed as a percentage of amplitude.
-More- 3/4	<b>More 3/4</b>	----	Display menu page 4/4

## Basic Operation

---

Press **More 3/4** softkey to display the **VOLTAGE** menu page 4/4.



Softkey	Options	Description
	----	Return to the <b>MEASURE</b> menu
<b>More 4/4</b>	----	Display menu page 1/4

# Basic Operation

## Time Measurements





Press **MEASURE** → **Time** to display the **TIME** menu page 1/5.



Softkey	Options	Description
<b>Frequency</b>	----	Frequency is defined as 1/period of the first cycle.
<b>Period</b>	----	Period is the time period of the first complete waveform cycle.
<b>Rise Time</b>	----	Rise Time is the time that the first positive-going edge takes to rise from 10% to 90% of its amplitude.
<b>Fall Time</b>	----	Fall Time is the time that the first negative-going edge takes to fall from 90% to 10% of its amplitude.
<b>More 1/5</b>	----	Display menu page 2/5

## Basic Operation

Press **More 1/5** softkey to display the **TIME** menu page 2/5.

TIME	Softkey	Options	Description
 + Width	<b>+Width</b>	----	Positive Width is the time between the 50% amplitude points of the first positive pulse.
 - Width	<b>-Width</b>	----	Negative Width is the time between the 50% amplitude points of the first negative pulse.
 + Duty	<b>+Duty</b>	----	Positive Duty is the ratio of the first positive width to its period, expressed as a percentage.
 - Duty	<b>-Duty</b>	----	Negative Duty is the ratio of the first negative width to its period, expressed as a percentage.
-More- 2/5	<b>More 2/5</b>	----	Display menu page 3/5

## Basic Operation

Press **More 2/5** softkey to display the **TIME** menu page 3/5.







Softkey	Options	Description
<b>Delay 1f+2f</b>	----	The time between the 50% amplitude points of the first positive-going edge of each channel.
<b>Delay 1f+2f</b>	----	The time between the 50% amplitude points of the first negative-going edge of each channel.
<b>Delay 1f+2f</b>	----	The time between the first positive-going edge of CH1 and the first negative-going edge of CH2 at each 50% amplitude point.
<b>Delay 1f+2f</b>	----	The time between the first negative-going edge of CH1 and the first positive-going edge of CH2 at each 50% amplitude point.
<b>More 3/5</b>	----	Display menu page 4/5

## Basic Operation

---

Press **More 3/5** softkey to display the **TIME** menu page 4/5.

TIME	Softkey	Options	Description
 Phase1→2	<b>Phase</b>	----	Phase 1→2 is the ratio of Delay 1→2 to the period of CH1, expressed in degrees.
 Phase2→1	<b>Phase</b>	----	Phase 2→1 is the ratio of Delay 2→1 to the period of CH2, expressed in degrees.
 X at Max	<b>X at Max</b>	----	X at Max is the X axis value (refer to Trigger point) at the first displayed occurrence of the waveform Maximum, starting from the left side of the display.
 X at Min	<b>X at Min</b>	----	X at Min is the X axis value (refer to Trigger point) at the first displayed occurrence of the waveform Minimum, starting from the left side of the display.
-More- 4/5	<b>More 4/5</b>	----	Display menu page 5/5

## Basic Operation

---

Press **More 4/5** softkey to display the **TIME** menu page 5/5.

TIME	Softkey	Options	Description
	↶	----	Return to the <b>MEASURE</b> menu
	<b>More 5/5</b>	----	Display menu page 1/5
↶			
-More- 5/5			

# Basic Operation

## Automatic Measurement Procedure

Press **MEASURE** → **Measure All** to turn on all Auto Measurements. Up to 20 kinds of measurements of current channel are displayed on the center of the screen.

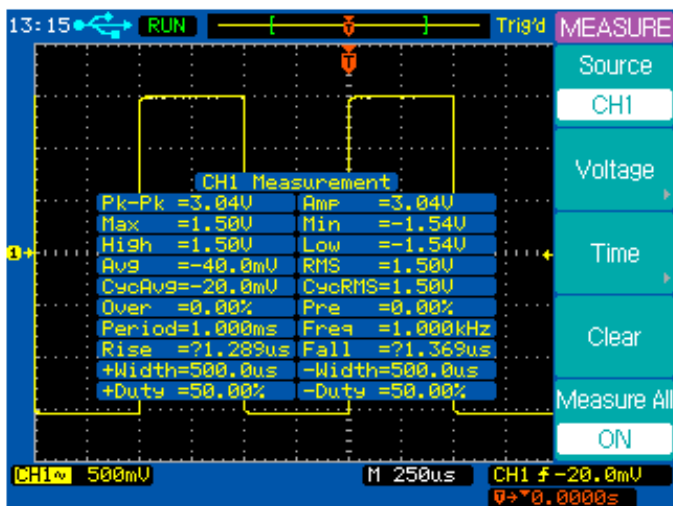

Press **Measure All** again to turn off all Auto Measurements.

Press **MEASURE** → **Voltage** to display the **VOLTAGE** menu or press **MEASURE** → **Time** to display the **TIME** menu.

Press softkey of voltage or time parameters you want to measure.

The selected parameter will be displayed on the bottom of the display.



## Basic Operation

---

Press **Clear** softkey to clear all displayed measurement parameter.

**Note:** *Up to three parameters can be displayed at the same time on the bottom of the display. Press the parameter softkey to add a new parameter when three parameters are already displayed. The first parameter will be pushed out of the display window and the new parameter will be displayed on the bottom right of the display screen.*

**Note:** *“\*\*\*\*” will be displayed when a parameter can not be measured correctly.*

# Basic Operation

## Measurement definitions

The following figure shows the voltage measurement points.

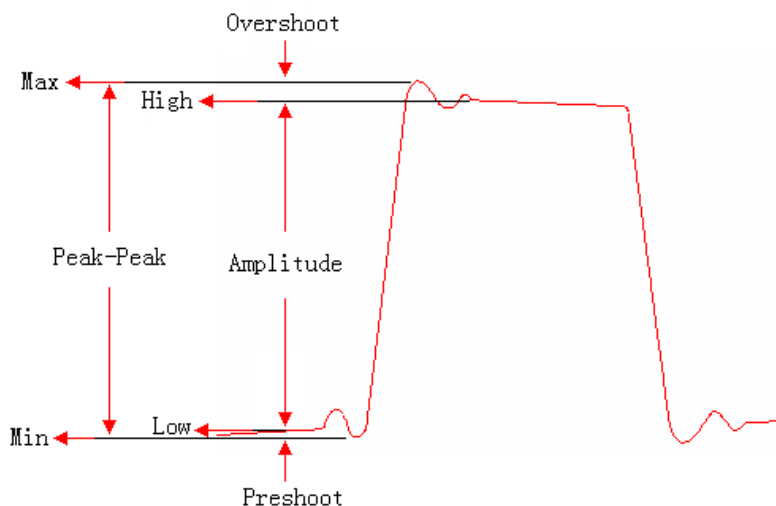

The following figure shows the time measurement points.

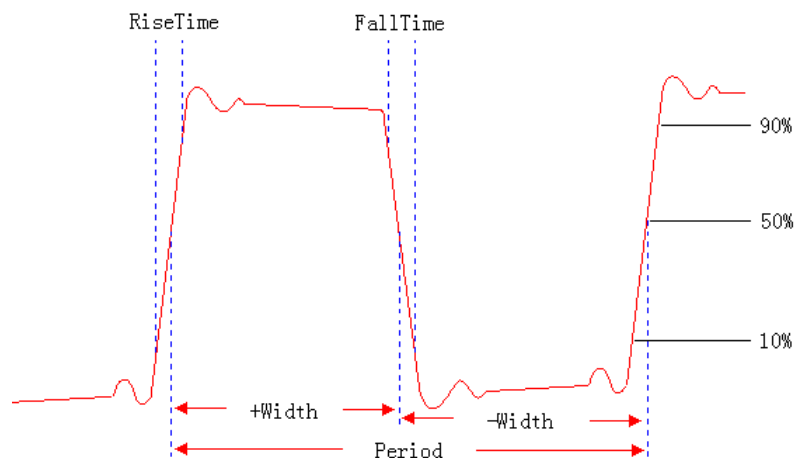

# Basic Operation

## SAVE/LOAD Menu

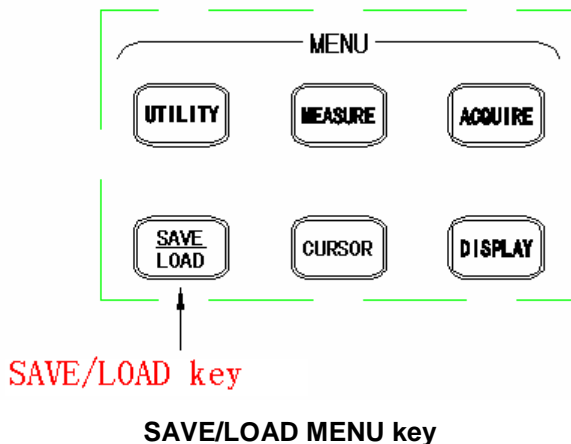

Press **SAVE/LOAD** key to display the **SAVE/LOAD** menu.

SAVE/LOAD	Softkey	Options	Description
Internal Storage ▶	<b>Internal Storage</b>	----	Display the <b>INTERNAL</b> menu.
External Storage ▶	<b>External Storage</b>	----	Display the <b>EXTERNAL</b> menu.
	<b>Factory</b>	----	Set the instrument to the factory default configuration.
Factory			

# Basic Operation

## Internal Storage

Press **SAVE/LOAD** → **Internal Storage** → **Storage type** to display the **INTERNAL** menu and select Waveforms storage type.

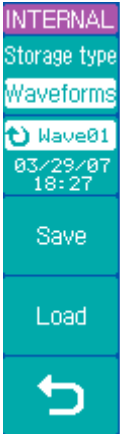
	<b>Softkey</b>	<b>Options</b>	<b>Description</b>
	<b>Storage type</b>	Waveforms	Waveform file format
		Setups	Setup file format
	<b>Wavexx</b> <b>mm/dd/yy</b> <b>hh/mm</b>	↻	Select a waveform file from Wave01 to Wave10. Date and time of the current file is displayed.
	<b>Save</b>	----	Save the display to current waveform file.
	<b>Load</b>	----	Load the current waveform file.
	↶	----	Return to the <b>SAVE/LOAD</b> menu

## Basic Operation

Press **SAVE/LOAD** → **Internal Storage** → **Storage type** to display the **INTERNAL** menu and select **Storage type**.

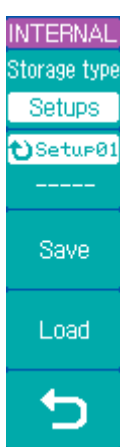



Softkey	Options	Description
<b>Storage type</b>	Waveforms	Waveform file format
	Setups	Setup file format
<b>Setupxx</b> <b>mm/dd/yy</b> <b>hh/mm</b>	↻	Select a setup file from Setup01 to Setup10. Date and time of the current file is displayed.
<b>Save</b>	----	Save the current configuration to the current setup file.
<b>Load</b>	----	Load from the current setup file.
↶	----	Return to the <b>SAVE/LOAD</b> menu

## Basic Operation

---

### External Storage

Press **SAVE/LOAD** → **External Storage** to display the **EXTERNAL** menu.







<b>EXTERNAL</b>	<b>Softkey</b>	<b>Options</b>	<b>Description</b>
New ▶	<b>New</b>	----	Create a new file or folder in the external memory.
Rename ▶	<b>Rename</b>	----	Rename the current file or folder.
Load	<b>Load</b>	----	Load the current file.
Delete ▶	<b>Delete</b>	----	Delete the current file or folder.
		----	Return to the <b>SAVE/LOAD</b> menu

**Note: The External Storage menu and operations will not be available until the external USB mass storage device is installed.**

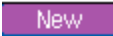
## Basic Operation

---

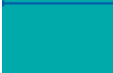
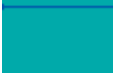
Press **SAVE/LOAD** → **External Storage** → **New** to display the **New** menu.

	Softkey	Options	Description
	<b>New File</b>	----	Display the <b>New File</b> menu.
	<b>New Folder</b>	----	Display the <b>New Folder</b> menu.
		----	Return to the <b>EXTERNAL</b> menu
			
			
			

## Basic Operation

---

Press **SAVE/LOAD** → **External Storage** → **New** → **New File** to display the **New File** menu.

New File	Softkey	Options	Description
Save as	<b>Save as</b>	Setups	Save as setup files
Setups		Waveforms	Save as waveform files
Enter Character		BMP	Save as BMP files
Delete Character		CSV	Save as CSV files
Save	<b>Enter Character</b>	----	Enter the selected character and go to the next character position.
↶	<b>Delete Character</b>	----	Delete the selected character.
	<b>Save</b>	----	Save the new file.
	↶	----	Return to the <b>New</b> menu



**Note: Maximum length of a file name is 8 characters.**  
**Press Enter Character to select a character position in the file name. Turn the entry knob to select a character. Press Delect Character to delete the current selected character. Press Enter Character to enter the selected character and go to the next character position.**



## Basic Operation

---



Press **SAVE/LOAD** → **External Storage** → **New** → **New Folder** to display the **New Folder** menu.

New Folder	Softkey	Options	Description
Enter Character	<b>Enter Character</b>	----	Enter the selected character and go to the next character position.
Delete Character	<b>Delete Character</b>	----	Delete the selected character.
Save	<b>Save</b>	----	Save the new folder.
		----	Return to the <b>New</b> menu

## Basic Operation

---

Press **SAVE/LOAD** → **External Storage** → **Rename** to display the **Rename** menu.

Rename	Softkey	Options	Description
Enter Character	<b>Enter Character</b>	----	Enter the selected character and go to the next character position.
Delete Character	<b>Delete Character</b>	----	Delete the selected character.
OK	<b>OK</b>	----	Rename the selected file or folder.
		----	Return to the <b>EXTERNAL</b> menu

## Basic Operation

---

Press **SAVE/LOAD** → **External Storage** → **Delete** to display the **Delete** menu.

Delete	Softkey	Options	Description
OK	<b>OK</b>	----	Confirm to delete the selected file or folder.
Cancel	<b>Cancel</b>	----	Cancel the delete operation.
↶	↶	----	Return to the <b>EXTERNAL</b> menu
↶			

# Basic Operation

## Software Update

Press **SAVE/LOAD** → **External Storage** to display the **EXTERNAL** menu.

Turn the entry knob to select the correct update file. File 2042A.UPT is selected as shown in the following figure.

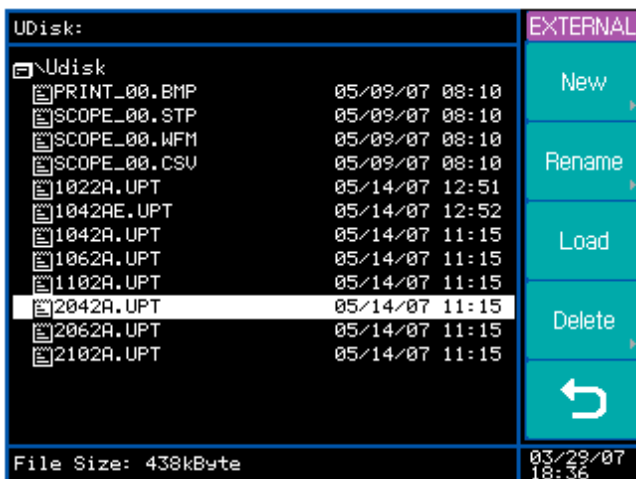

Press **Load** softkey to start the update operation. A Loading and then an updating progress bar will be displayed and indicate the process of the update operation.

Finally, information “**Restart to complete updating**” will be displayed to remind you to restart the instrument.

If the software update is failed, repeat the above procedures to update again.

## Basic Operation

---

**Note:** *The default file extension of the update file is ".upt".*

*Select the correct update file according to the model of the oscilloscope. Error message "Incompatible file " will be displayed when the model is not identical.*

**Note:** *The power supply of the oscilloscope can not be turned off during the updating process. If this happens, you will have to return the instrument to factory for service.*

## Basic Operation

---

### CURSOR Menu

You can measure waveform data using cursors. Cursors are horizontal and vertical markers that indicate X-axis values (usually time) and Y-axis (usually voltage) on a selected waveform source. The position of the cursors can be moved by turning the entry knob.

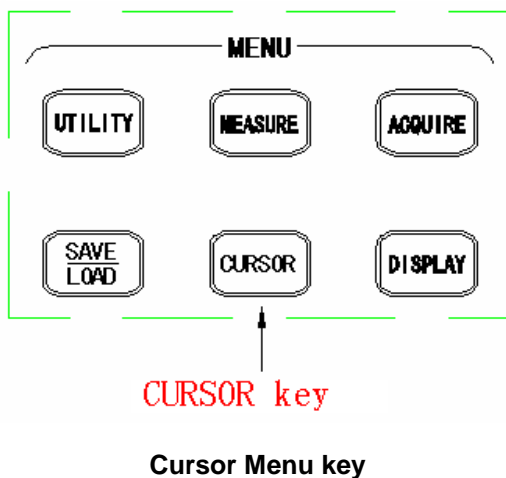

The oscilloscope provides three kinds of cursor measurement modes: **Manual**, **Auto** and **Track**.

## Basic Operation

### Manual Mode

In the manual mode, you can move the cursors to measure the voltage or time on the select source waveform.

Press **CURSOR** → **Mode** to display the **CURSOR** menu and select the **Manual** mode. Press the **Type** softkey to select **Voltage** measurement.

CURSOR
Mode
Manual
Source
CH1
Type
Voltage
Y1 -- 1.92U
Y2 --- -2.00U
$\Delta Y$ 3.92U

Softkey	Options	Description
<b>Mode</b>	Manual	Manual cursor measurement
	Auto	Auto cursor measurement
	Track	Track cursor measurement
<b>Source</b>	CH1	Measure CH1
	CH2	Measure CH1
	MATH	Measure MATH
<b>Type</b>	Voltage	Measure voltage value
	Time	Measure time value
<b>Y1--</b> <b>Y2--</b>	↻	Press this softkey to active Y1, Y2, or both Y1 and Y2 cursors for adjustment. Current voltage values for Y1 and Y2 are displayed in the softkey
<b><math>\Delta Y</math></b>	----	The difference value between Y1 and Y2 cursors.

## Basic Operation

Press **CURSOR** → **Mode** to display the **CURSOR** menu and select the **Manual** mode. Press the **Type** softkey to select **Time** measurement.

CURSOR	Softkey	Options	Description
Mode	<b>Mode</b>	Manual	Manual cursor measurement
Manual		Auto	Auto cursor measurement
Source		Track	Track cursor measurement
CH1	<b>Source</b>	CH1	Measure CH1
Type		CH2	Measure CH2
Time		MATH	Measure MATH
t) X1 -- -2.000ns	<b>Type</b>	Voltage	Measure voltage value
t) X2 -- 28.40ns		Time	Measure time value
ΔX 30.40ns	↻X1-- ↻X2--	↻	Press this softkey to select X1, X2, or both X1 and X2 cursors for adjustment. Current time values for X1 and X2 are displayed in the softkey
1/ΔX 32.89MHz	ΔX 1/ΔX	----	ΔX is the time difference value between X1 and X2 cursors. 1/ΔX is the frequency between X1 and X2



## Basic Operation

---

### **TRACK Mode**

Two cross hair cursors are displayed on the screen in the track mode. The cross hair cursors track the waveform automatically. You can move the cross hair cursors horizontally by turning the entry knob. The X,Y values of each cross hair cursor are displayed in the softkey area, or on the top right corner when menu is off.

## Basic Operation

Press **CURSOR** → **Mode** to display the **CURSOR** menu and select the **Track** mode.

CURSOR	Softkey	Options	Description
Mode	<b>Mode</b>	Manual	Manual cursor measurement
Track		Auto	Auto cursor measurement
Cursor A		Track	Track cursor measurement
CH1	<b>Cursor A</b>	CH1	Track CH1 with Cursor A
Cursor B		CH2	Track CH2 with Cursor A
None		None	Turn off Cursor A
↻ Ax -- -8.000uS	<b>Cursor B</b>	CH1	Track CH1 with Cursor B
Ay -- 0.00U		CH2	Track CH2 with Cursor B
↻ Bx -- *****		None	Turn off Cursor B
By -- *****	↻ Ax -- Ay --	↻	Press this softkey to select Cursor A for adjustment. Current X, Y axis values for tacking point of Cursor A are displayed in the softkey
	↻ Bx -- By --	↻	Press this softkey to select Cursor B for adjustment. Current X, Y axis values for tacking point of Cursor B are displayed in the softkey

## Basic Operation

---

### **AUTO Mode**

The Auto mode cursors are displayed only when auto measurement function is enabled. The oscilloscope displays the auto cursors corresponding to the latest auto measurement parameter. No Auto cursors will be displayed when no auto measurement parameter is selected.

# Basic Operation

---



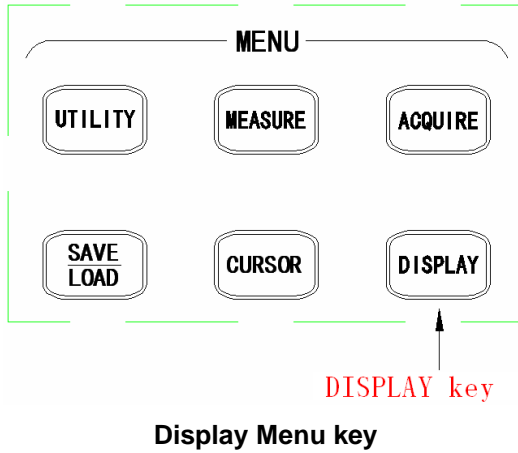

## DISPLAY Menu



## Basic Operation

---

Press **DISPLAY** menu key to display the **DISPLAY** menu page 1/2.

<b>Softkey</b>	<b>Options</b>	<b>Description</b>
<b>Type</b>	Vector	Vector mode fills the space between adjacent sample points in the waveform.
	Dots	Dot mode only displays the sample points
<b>Grid</b>		Display both grids and axes.
		Turn off the axes.
		Turn off the grids.
		Turn off both grids and axes.
<b>Contrast</b>		Adjust the display contrast.
<b>Color Setup</b>	----	Select Color scheme.
<b>More 1/2</b>	----	Display menu page 2/2.



## Basic Operation

---

Press **More 1/2** softkey to display the **DISPLAY** menu page 2/2.

DISPLAY	Softkey	Options	Description
Persist OFF	<b>Persist</b>	ON	The scope updates the waveform without erasing the previous sample points.
Clear Persistence Waveforms Normal		OFF	Turn off the persistence function
-More- 2/2	<b>Clear Persistence</b>	----	Press the softkey to erase the previous sample points.
	<b>Waveforms</b>	Normal	Select the color display.
		Monochrome	Select the monochrome display.
	<b>More 2/2</b>	----	Display menu page 1/2.

### RUN Controls

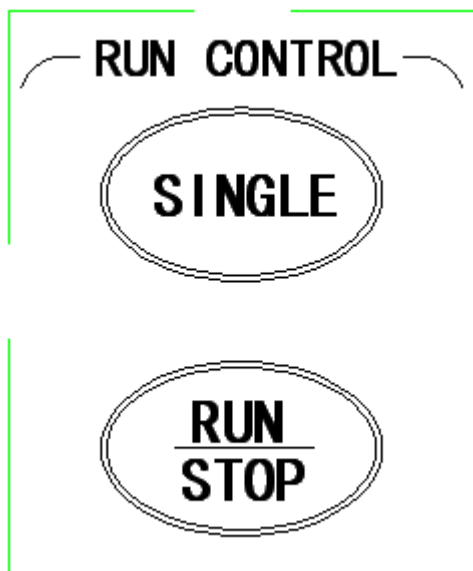

**Run controls**

Press the **SINGLE** key to execute a single-shot acquisition. The key will illuminate in yellow until the oscilloscope is triggered.

Press the **RUN/STOP** key to make the oscilloscope start looking for a trigger. The **RUN/STOP** key will illuminate in green. When the trigger mode is set to Normal mode, the display will not update until a trigger is found. If the trigger mode is set to Auto mode, the oscilloscope looks for a trigger,

## Basic Operation

---

and if no trigger is found, it will be triggered automatically and the waveform of input signals will be showed immediately.

Press the **RUN/STOP** key again to stop acquiring data and the **RUN/STOP** key will illuminate in red. Now you can pan across and zoom in on the acquired waveform.



# 3. Application Examples

This section presents 7 typical application examples. These simplified examples highlight the features of the oscilloscope and give you ideas of how to solve your own test problems.

### Make Simple Measurements

You need to measure the amplitude and frequency of an unknown signal on CH1.

Perform following steps to quickly display the signal.

- Connect the channel 1 probe to the unknown signal.
- Press the **AUTO** key.

The oscilloscope automatically sets vertical, horizontal, and trigger controls. You can adjust any of these controls manually if you need to optimize the display of the waveform. When you are using both CH1 and CH2 channels, the Autoset function sets the vertical controls for each channel and uses the CH1 channel to set the horizontal and trigger controls.

The oscilloscope can take automatic measurements of most displayed signals. Perform following steps to measure signal amplitude and frequency.

## Application Examples

---

- Press the **MEASURE** key to display the **MEASURE** menu.
- Press the **Voltage** softkey to display the **VOLTAGE** menu.
- Press the **Amplitude** softkey to measure the Amplitude. The amplitude value will be displayed at the bottom of the screen.
- Press **MEASURE** key again to display the **MEASURE** menu.
- Press **Time** softkey to display the **TIME** menu.
- Press the **Frequency** softkey to measure the frequency. The frequency value will be displayed at the bottom of the screen to the right of the voltage value.

## Application Examples

---

### Capture a Single-Shot Signal

Digital Storage Oscilloscope can easily be used to capture the single-shot or unrepeatable signal. Perform following steps to capture a single-shot signal.

- Connect the channel 1 probe to the unknown signal.
- Press the trigger **MENU** key to display the **TRIGGER** menu.
- Press the **Source** softkey to select CH1.
- Press the **Mode** softkey to select the Auto trigger mode.
- Adjust the vertical and horizontal controls to observe the the signal roughly. And find out the right Trigger Type and Trigger mode.
- Press the **Type** softkey from the **TRIGGER** menu page 1/2 to select Pulse trigger type.
- Press **More 1/2** sofkey to display the **TRIGGER** menu page 2/2.
- Press **Mode** softkey to select Normal Trigger mode.
- Press **More 2/2** sofkey to display the **TRIGGER** menu page 1/2.
- Press **Pulse Mode** softkey to select  (positive less than).
- Rotate the entry knob (↻) to set up the pulse width.
- Press the **SINGLE** key to start the acquisition system and search for the trigger condition. The **SINGLE** key is illuminated in yellow.

## Application Examples

---

- When trigger condition is met, the captured waveform is displayed, the **SINGLE** key is extinguished and the **RUN/STOP** key is illuminated in red.

## Application Examples

### Reduce the Random Noise on a Signal

If the test signal is noisy, you can set up the oscilloscope to reduce the noise on the displayed waveform. First, you stabilize the displayed waveform by removing the noise from the trigger path. Second, you reduce the noise on the displayed waveform.

- Connect a signal to the oscilloscope. Press **AUTO** key to display the signal quickly.

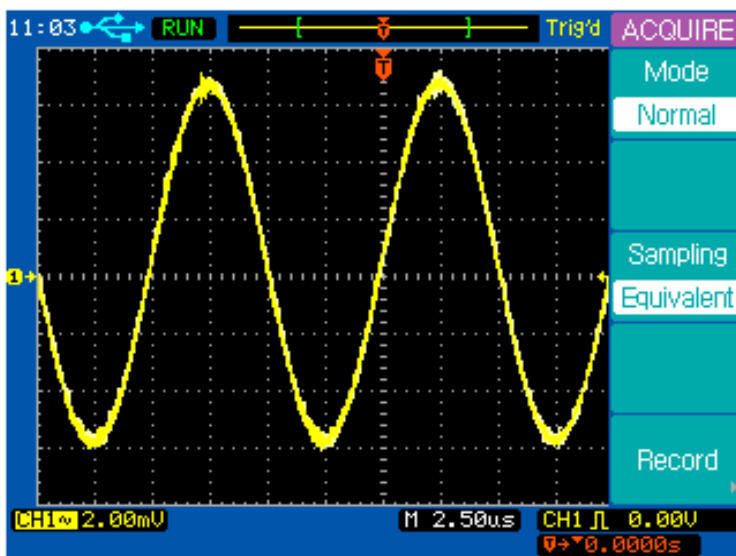

- Press the Trigger **MENU** key to display the **TRIGGER** menu.

## Application Examples

- Press **Type** softkey to select **Edge** trigger type.
- Press **Coupling** to select **HF Reject** or **LF Reject** coupling mode to reduce the noise from the trigger channel.
- Press the **ACQUIRE** key to display the **ACQUIRE** menu.
- Press the **Mode** softkey to select **Average** mode.
- Rotate the entry knob (↻) to set the number of averages that best eliminates the noise from the displayed waveform.

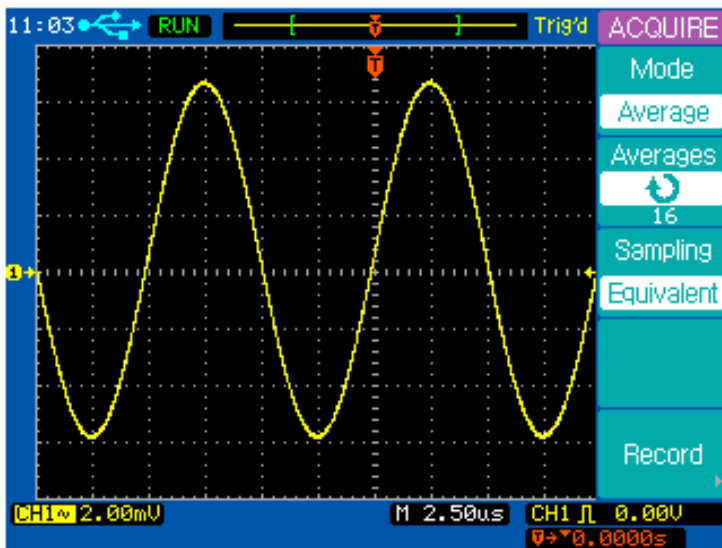

# Application Examples

## Trigger on a Video Signal

Video trigger can be used to capture the standard video signals. The trigger circuit detects the vertical and horizontal interval of the waveform and produces triggers based on the Video trigger setting you have selected.

### Trigger on Odd or Even Fields of the Video Signal

- Press the Trigger **MENU** key to display the **TRIGGER** menu.
- Press the **Type** softkey to select the **Video** trigger mode.
- Press **Source** softkey to select **CH1**.
- Press **Polarity** softkey to select negative polarity  $\llcorner$ .
- Press **Sync** softkey to select **Odd Field** or **Even Field**.

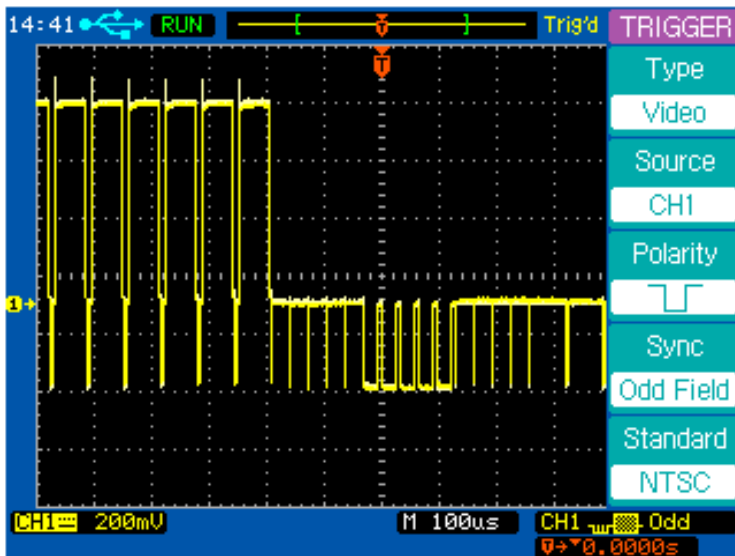

## Application Examples

### Trigger on a Specific Line or All Lines of the Video Signal

- Press the Trigger **MENU** key to display the **TRIGGER** menu.
- Press the **Type** softkey to select the **Video** trigger mode.
- Press **Source** softkey to select **CH1**.
- Press **Polarity** softkey to select negative polarity  $\overline{\square}$ .
- Press **Sync** softkey to select **Line #** or **All Lines**.

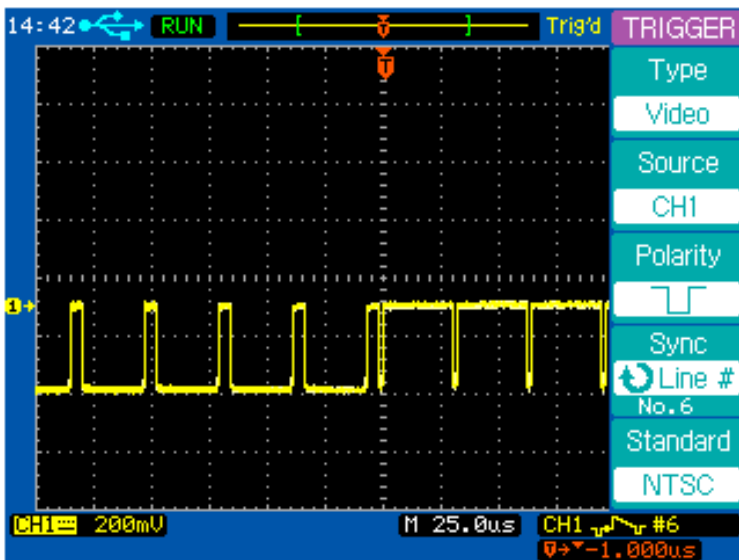



## Application Examples

---

### PASS/FAIL Measurement

The oscilloscope measures and compares the input signal with predefined Pass/Fail thresholds. If the input signal is within the thresholds, PASS signal will be outputted. If the input signal exceeds the thresholds, FAIL signal will be outputted.

Perform following steps to make a PASS/FAIL measurement.

- Press **UTILITY** key to display the **UTILITY** menu page 1/2.
- Press **More 1/2** softkey to display the **UTILITY** menu page 2/2/
- Press **Pass/Fail** softkey to display the **PASS/FAIL** menu.
- Press **Enable Test** softkey to turn on the **PASS/FAIL** measurement.
- Press **Setup Mask** softkey to display the **MASK** menu.
- Press **X Mask** softkey and then rotate the entry knob to setup the horizontal threshold.
- Press **Y Mask** softkey and then rotate the entry knob to setup the vertical threshold.
- Press **Creat Mask** softkey to update the thresholds.
- Press **↶** softkey to return to the **PASS/FAIL** menu.
- Press **More 1/2** softkey to display the **PASS/FAIL** menu page 2/2.
- Press **Msg Display** softkey to display the Pass/Fail measurement results on the top left corner of the screen.

## Application Examples

- Press the **Output** softkey to set how to output the measurement results.
- Press **More 2/2** to display the **PASS/FAIL** menu page 1/2.
- Press the **Operate** softkey to start PASS/FAIL measurement.

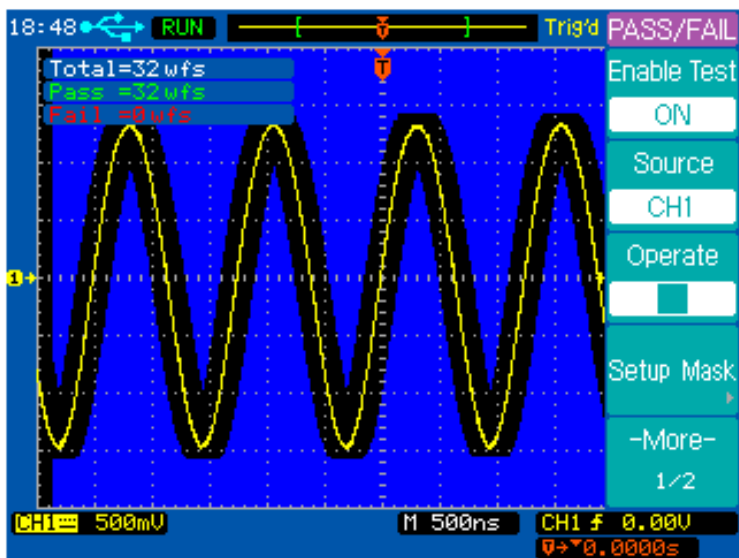

# Application Examples

## Waveform Recorder

Waveform recorder lets you record waveforms, playback waveforms and save the waveforms.

Perform the following steps to record waveforms.

- Press the **ACQUIRE** key to display the **ACQUIRE** menu.
- Press the **RECORD** softkey to display the **RECORD** menu.
- Press the **Mode** softkey to select **Record** mode.
- Press the **Source** softkey to select the source channel **CH1**.
- Press the **Operate** key to start recording, total recorded frame count is displayed on the top left screen.

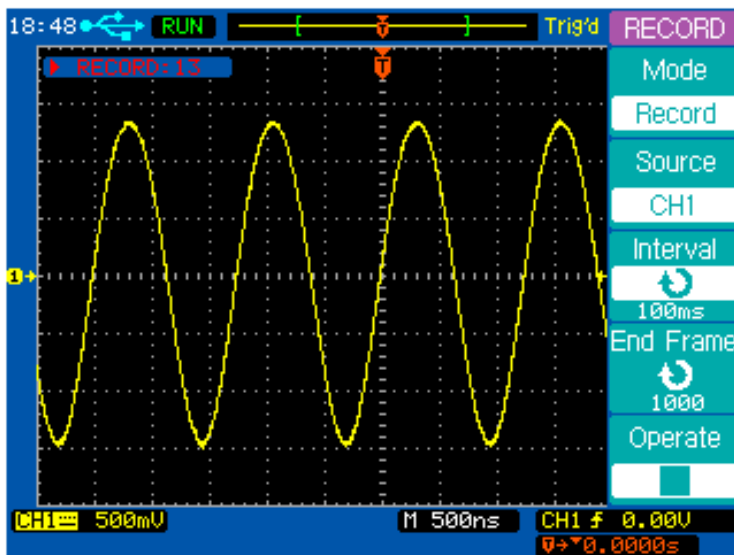

## Application Examples

Perform the following steps to playback the waveforms.

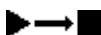
- Press the **ACQUIRE** key to display the **ACQUIRE** menu.
- Press the **RECORD** softkey to display the **RECORD** menu.
- Press the **Mode** softkey to select **Play back** mode.
- Press **Play Mode** softkey to select  or  mode.
- Press **Start Frame** softkey and turn the entry knob to set the start frame.
- Press **End Frame** softkey and turn the entry knob to set the end frame.
- Press **Interval** softkey and turn the entry knob to set the interval time.
- Press **Operate** softkey to playback the waveform.

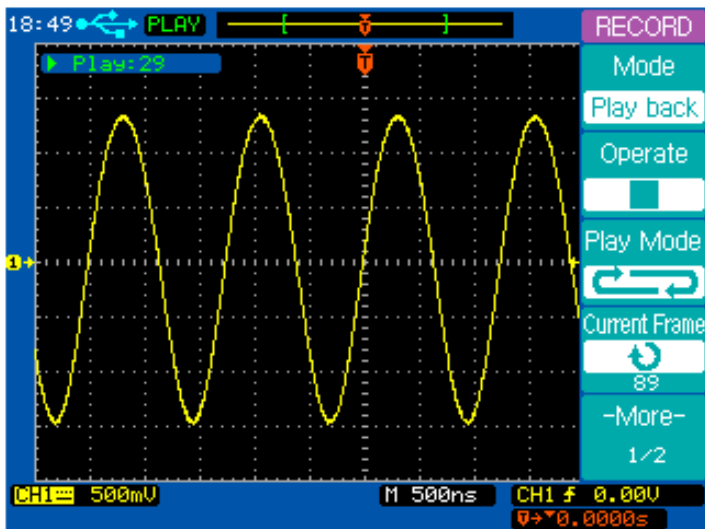

## Application Examples

---

Perform the following steps to save the waveform recorded.

- Press the **ACQUIRE** key to display the **ACQUIRE** menu.
- Press the **RECORD** softkey to display the **RECORD** menu.
- Press the **Mode** softkey to select **Save/Recall** mode.
- Press **Start Frame** softkey and turn the entry knob to set the start frame.
- Press **End Frame** softkey and turn the entry knob to set the end frame.
- Press the **Internal Storage** softkey to Save or Load the recorded waveform from the internal memory.

# Application Examples

---

## Cursor Measurements

You can use the cursors to quickly take time and voltage measurements on a waveform. You can use the cursors to measure the amplitude and frequency of a FFT waveform. You can also use the cursors to measure the phase difference between two signals with the same frequency when X-Y horizontal mode is selected.

### Measure the time and volgate on normal waveform

Perform the following steps to take time and frequency measurements.

- Press the **CURSOR** key to display the **CUROSR** menu.
- Press **Mode** softkey to select the **Manual** mode.
- Press **Type** softkey to select the **Time** type.
- Press **X1--/X2--** softkey or press the entry knob to select X1 cursor.
- Rotate the entry knob ↻ to move the X1 cursor.
- Press **X1--/X2--** softkey or press the entry knob to select X2 cursor.
- Rotate the entry knob ↻ to move the X2 cursor.
- $\Delta X$  and  $1/\Delta X$  are displayed in the softkey area.  $\Delta X$  is the time difference between X1 and X2;  $1/\Delta X$  is the frequency between X1 and X2.

## Application Examples

---

Perform the following steps to take voltage measurement.

- Press the **CURSOR** key to display the **CURSOR** menu.
- Press **Mode** softkey to select the **Manual** mode.
- Press **Type** softkey to select the **Voltage** type.
- Press **↶Y1--/↷Y2** softkey or press the entry knob to select Y1 cursor.
- Rotate the entry knob **↶** to move the Y1 cursor.
- Press **↶Y1--/↷Y2** softkey or press the entry knob to select Y2 cursor.
- Rotate the entry knob **↷** to move the Y2 cursor.
- $\Delta Y$  displayed in the softkey area is the voltage difference between Y1 and Y2.

## Application Examples

---

### Measure the frequency and amplitude on FFT waveform

Perform the following steps to take frequency measurement.

- Press the **MATH** key to display the **Math** menu.
- Press the **Operate** softkey to select **FFT** and display the **FFT** menu.
- Press the **CURSOR** key to display the **CUROSR** menu.
- Press **Mode** softkey to select the **Manual** mode.
- Press **Source** softkey to select **FFT**.
- Press **Type** softkey to select the **Time** type.
- Press **↶X1--/↷X2** softkey or press the entry knob to select X1 cursor.
- Rotate the entry knob ↶ to move the X1 cursor.
- Press **↶X1--/↷X2** softkey or press the entry knob to select X2 cursor.
- Rotate the entry knob ↷ to move the X2 cursor.
- $\Delta X$  displayed in the softkey area is the frequency difference between X1 and X2.  $1/\Delta X$  is the time difference between X1 and X2.

Perform the following steps to take voltage measurement.

- Press the **MATH** key to display the **Math** menu.
- Press the **Operate** softkey to select **FFT** and display the **FFT** menu.
- Press the **CURSOR** key to display the **CUROSR** menu.
- Press **Mode** softkey to select the **Manual** mode.



## Application Examples

---

- Press **Source** softkey to select **FFT**.
- Press **Type** softkey to select the **Voltage** type.
- Press **↶Y1--/↷Y2**—softkey or press the entry knob to select Y1 cursor.
- Rotate the entry knob ↶ to move the Y1 cursor.
- Press **↶Y1--/↷Y2**—softkey or press the entry knob to select Y2 cursor.
- Rotate the entry knob ↷ to move the Y2 cursor.
- $\Delta Y$  displayed in the softkey area is the voltage difference between Y1 and Y2.

## Application Examples

---

### Measure the Phase Difference Between Two Signals of the Same Frequency under X-Y Display Mode.

- Connect a sine wave signal to channel 1 and a sine wave signal of the same frequency but out of phase to channel 2.
- Press horizontal **MENU** key to display the **Horizontal** menu.
- Press **X-Y** softkey to select **X-Y** display mode
- Center the signal on the display with the vertical control knob of each channel.
- Use the vertical scale control knob of each channel to expand the signal for convenient view.
- Press the **CURSOR** key to display the **CURSOR** menu.
- Press **Mode** softkey to select the **Manual** mode.
- Press **Source** softkey to select **CH2**.
- Press **Type** softkey to select the **Voltage** type.
- Press **Y1--/Y2--** softkey or press the entry knob to select Y1 cursor.
- Rotate the entry knob ↻ to move the Y1 cursor to the top of the signal.
- Press **Y1--/Y2--** softkey or press the entry knob to select Y2 cursor.
- Rotate the entry knob ↻ to move the Y2 cursor to the bottom of the signal.

## Application Examples

---

- $\Delta Y$  displayed in the softkey area is the voltage difference  $D$  (or  $2B$ ) between  $Y1$  and  $Y2$ .
- Press  $\text{Y1--/Y2}$ —softkey or press the entry knob to select  $Y1$  cursor.
- Rotate the entry knob  $\curvearrowright$  to move the  $Y1$  cursor to the upper intersection of the signal and  $Y$  axis.
- Press  $\text{Y1--/Y2}$ —softkey or press the entry knob to select  $Y2$  cursor.
- Rotate the entry knob  $\curvearrowright$  to move the  $Y2$  cursor to the lower intersection of the signal and  $Y$  axis.
- $\Delta Y$  displayed in the softkey area is the voltage difference  $C$  (or  $2A$ ) between  $Y1$  and  $Y2$ .
- Calculate the phase difference using the formula below.

$$\theta = \pm \arcsin \frac{C}{D} \quad \text{or} \quad \theta = \arcsin \frac{A}{B}.$$

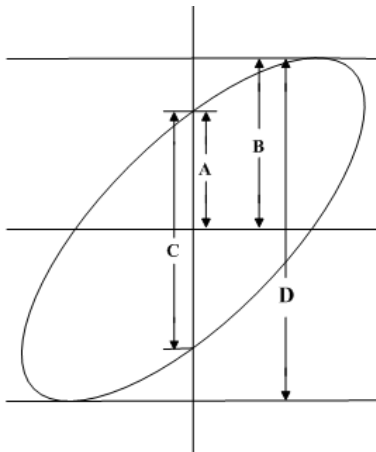



# 4. System Message and General Problems

## System Message

**Function is not available:** The control knob, key, or softkey is not available under a specific operating condition. This message will be displayed when you try to operate these knob, key, or softkey.

**The control is at its limit:** This message will be displayed when the maximum or minimum value is reached by turning the Entry knob, Vertical Control knobs, Horizontal Control knobs, or Trigger Level knob.

**Total is at its maximum:** This message will be displayed when the maximum value of Total count for PASS/FAIL is reached.

**Record is completed:** This message will be displayed when the number of waveforms (set in the **End Frame** softkey) have been recorded.

## System Message and General Problems

---

**No external memory:** This message will be displayed when you try to save a file to an external mass storage device which has not been installed.

**Save error:** This message will be displayed when you fail to save a file to the internal or external memory.

**Empty storage memory:** This message will be displayed when you try to load a file which does not exist from the internal memory.

**Unrecognized file:** This message will be displayed when you try to load a file which can not be recognized by the oscilloscope from the external memory.

**Update failed:** This message will be displayed when software update is failed.

**No record data:** This message will be displayed when you try to save a record file without record data.

**Record is failed:** This message will be displayed when waveform record is failed.

**Factory setup is recalled:** This message will be displayed when the default factory configuration is recalled.

## System Message and General Problems

---

**No signal is found:** This message will be displayed when you press the **AUTO** key without any signal connected to each channel.

**No printer is found:** This message will be displayed when you try to print the screen to a printer which has not been connected.

**Invalid data:** This message will be displayed when you try to save a \*.CSV file without any valid CSV data.

**Load finished:** This message will be displayed when a file has been successfully loaded from the internal or external memory.

**Save finished:** This message will be displayed when a file has been successfully saved to the internal or external memory.

**Incompatible file:** This message will be displayed when the update software is not identical with the model type.

**Load error:** This message will be displayed when you fail to load a file from the internal or external memory.

**Restart to complete updating:** This message will be displayed to let you restart the oscilloscope when the software update is successfully finished.

## System Message and General Problems

---

**USB device is installed:** This message will be displayed when a USB device is connected and recognized by the oscilloscope.

**USB device is removed:** This message will be displayed when a USB device is removed from the oscilloscope.

**Print finished:** This message will be displayed when the current waveform is printed successfully.

**Print failed:** This message will be displayed when the current waveform is not printed successfully.

**Unsupported printer:** This message will be displayed when an unsupported printer is connected.

**USB host error:** This message will be displayed when the USB host control circuit is not working normally.

**Setup finished:** This message will be displayed when the Date & Time is set successfully.

**Setup failed:** This message will be displayed when the Date & Time is not set successfully.



# System Message and General Problems

---

## General Problems

If there is no display on the screen.

- Check that the power cord is connected to the oscilloscope and to a live power source.
- Check that the power switch is on.
- Check that the display contrast is adjust properly.
- Contact our engineer if there is still no display.

If there is no waveform displayed.

- Check that the oscilloscope probe lead wires are securely inserted into the connector assembly and that the probe clips make good contact with the probe lead wires.
- Check that the probe clips are securely connected to points in the circuit under test and that the ground is connected.
- Check that the circuit under test is power on.
- Press the **AUTO** key again.

If the waveform display is not stable.

- Check that the trigger Source channel is actually the channel to which the trigger signal is connected.
- Check that the proper trigger type is selected. Video type is only used to trigger a Video signal. Proper trigger type is essential to acquire a stable display.

## System Message and General Problems

---

- Try to use the HF Reject or LF Reject to reduce the noise of the trigger signal.

If the amplitude is not identical with the actual voltage.

- Check that the attenuation factor of the probe is identical with the attenuation factor set in the channel menu.

## 5. Specifications and Characteristics

### Specifications

All specifications are warranted. Specifications are valid after a 30 minutes warm-up time and within  $\pm 5^{\circ}\text{C}$  of last “Self-Cal” temperature.

Bandwidth	25MHz: TDO1022A 40MHz: TDO1042AE, TDO1042A, TDO2042A 60MHz: TDO1062A, TDO1062B, TDO2062A, TDO2062B 100MHz: TDO1102A, TDO1102B, TDO2102A, TDO2102B 200MHz: TDO1202B, TDO2202B
DC Vertical Gain Accuracy	2 mV/div to 5 mV/div: $\pm 4\%$ 10 mV/div to 5 V/div: $\pm 3\%$

# Specifications and Characteristics

## Characteristics

All characteristics are the typical performance values and are not warranted. Characteristics are valid after a 30 minute warm-up time and within  $\pm 5^{\circ}\text{C}$  of last "Self-Cal" temperature.

### Vertical system

Scope channels	2 channels plus external trigger input.
Bandwidth	25MHz: TDO1022A 40MHz: TDO1042AE, TDO1042A, TDO2042A 60MHz: TDO1062A, TDO1062B, TDO2062A, TDO2062B 100MHz: TDO1102A, TDO1102B, TDO2102A, TDO2102B 200MHz: TDO1202B, TDO2202B
Calculated rise time ( $=0.35/\text{bandwidth}$ )	14.0ns: TDO1022A 8.75ns: TDO1042AE, TDO1042A, TDO2042A 5.83ns: TDO1062A, TDO1062B, TDO2062A, TDO2062B 3.50ns: TDO1102A, TDO1102B, TDO2102A, TDO2102B 1.75ns: TDO1202B, TDO2202B
Coupling	AC, DC, GND
BW Limit	20MHz selectable except TDO1022A
DC Vertical Gain	2 mV/div to 5 mV/div: $\pm 4\%$
Accuracy	10 mV/div to 5 V/div: $\pm 3\%$

## Specifications and Characteristics

DC Measurement	2 mV/div to 5 mV/div: $\pm(4\% \times \text{reading} + 0.1 \times \text{V/div} + 0.5 \text{ mV})$ 10 mV/div to 5 V/div: $\pm(3\% \times \text{reading} + 0.1 \times \text{V/div} + 1.0 \text{ mV})$
Position range	$\pm 8$ divisions from the center of the screen
Attenuation factor	$\times 1$ , $\times 10$ , $\times 100$ , $\times 1000$
Channel common mode rejection	100:1 at 60Hz 20:1 at 10MHz <sup>[1]</sup>
Lower frequency limit, AC coupled	$\leq 5\text{Hz}$ at BNC $\leq 1\text{Hz}$ when using a 10X passive probe
Channel to channel crosstalk	$\geq 100:1$ at 1MHz $\geq 100:1$ at 10MHz <sup>[1]</sup>
Input Impedance	$1\text{M}\Omega \pm 2\%    19\text{pF} \pm 3\text{pF}$ or $50\Omega \pm 2\%$ (only for TDO1202B, TDO2202B)
Maximun input	$400\text{V}_{\text{pk}}$ @ $1\text{M}\Omega$ $5\text{V}_{\text{rms}}$ @ $50\Omega$ (only for TDO1202B, TDO2202B)
Differential delay	150ps between two channels with the same scale and coupling settings

<sup>[1]</sup> Bandwidth reduced to 6MHz with a 1X probe.

# Specifications and Characteristics

---

## Horizontal system

Time base range	200Mps: 5 ns/div to 50 s/div, 1-2.5-5 step 400Mps: 2.5 ns/div to 50 s/div, 1-2.5-5 step 1Gsps : 2 ns/div to 50 s/div,1-2-5 step
Modes	Main, Delayed, Roll and X-Y
Time base accuracy	$\pm 0.01\%$
Input of X-Y mode	Channel 1 is the X-axis input Channel 2 is the Y-axis input
Bandwidth of X-Y mode	25MHz: TDO1022A 40MHz: TDO1042AE, TDO1042A, TDO2042A 60MHz: TDO1062A, TDO1062B, TDO2062A, TDO2062B 100MHz: TDO1102A, TDO1102B, TDO2102A, TDO2102B 200MHz: TDO1202B, TDO2202B
Phase error of X-Y mode	$\pm 3^\circ$

# Specifications and Characteristics

---

## Measurements

Voltage measurement	Maximum, Minimum, Peak-to-Peak, High, Low, Amplitude, Average, RMS, Cycle Average, Cycle RMS, Overshoot, Preshoot
Time measurement	Frequency, Period, +Width, -Width, +Duty, -Duty, Rise time, Fall time, Delay, Phase, X at MAX, X at MIN
Math	CH1-CH2, CH1+CH2, CH1×CH2, FFT (2k points)
Cursors	Manual, Automatic, and Track
Counter	Built-in 5-digit frequency counter. Count up to the oscilloscope's maximum bandwidth.

# Specifications and Characteristics

---

## Trigger system

Source	CH1, CH2, EXT, EXT/5, EXT(50Ω) (only available for TDO1202B or TDO2202B), AC Line, Alternating.
Modes	Auto, Normal, Single
Coupling	DC, AC, LF-Reject, HF-Reject
Type	Edge, Pulse, Video
Trigger sensitivity, Edge Trigger Type, DC coupling	CH1,CH2: 1div from DC to 10MHz EXT: 100mV from DC to 10MHz 200mV from 10MHz to full Bandwidth EXT/5: 500mV from DC to full Bandwidth
Trigger sensitivity, Edge Trigger Type, AC coupling	Same as DC coupling at 50 Hz and above
Trigger sensitivity, Edge Trigger Type, LF REJ	Same as the DC coupling limits for frequencies above 100kHz, attenuates signals below 8kHz
Trigger sensitivity, Edge Trigger Type, HF REJ	Same as the DC coupling limits from DC to 10kHz, attenuates signals above 150kHz
Trigger sensitivity, Video Trigger Type	Internal: Pk to Pk amplitude of 2 divisions EXT: 400 mV EXT/5: 2V
Signal formats and Field Rates, Video Trigger Type	Supports NTSC, PAL, and SECAM broadcast systems for any field or any line



## Specifications and Characteristics

---

Trigger level range	$\pm 8$ divisions from screen center EXT: $\pm 1.6V$ EXT/5: $\pm 8V$
Holdoff Range	100ns to 1.5s
Trigger Level Accuracy	Internal: $\pm 0.3 \text{ div} \times \text{volts/div}$
Input impedance	$1M\Omega \pm 2\%    19pF \pm 3pF$ or $50\Omega \pm 2\%$ (only for TDO1202B, TDO2202B)
Maximum input	$400V_{pk}$ @ $1M\Omega$ $5V_{rms}$ @ $50\Omega$ (only for TDO1202B, TDO2202B)
SET LEVEL TO 50%	Operates with input signal $\geq 50 \text{ Hz}$ .
Pulse Width Trigger mode	Trigger when Less than, Greater than, Equal Positive pulse , Negative pulse
Pulse Width Range	20ns to 10s

# Specifications and Characteristics

---

## Storage and I/O

Internal memory	10 setups and waveforms can be saved and recalled internally.
File format	Setup file(*.STP), Waveform file(*.WFM), BMP file(*.BMP), CSV file(*.CSV), all files have the real time and date messages except TDO1022A and TDO1042AE.
Standard ports	USB host USB device (except TDO1022A and TDO1042AE)
Optional ports	RS232C+PASS/FAIL OUT GPIB+RS232C+PASS/FAIL OUT

# Specifications and Characteristics

---

## Acquisition system

Max real time sample rate	200MHz: TDO1022A, TDO1042AE 400MHz: TDO1042A, TDO2042A, TDO1062A, TDO2062A, TDO1102A, TDO2102A, 1GHz: TDO1062B, TDO2062B, TDO1102B, TDO2102B, TDO1202B, TDO2202B
Max equivalent sample rate	20GHz: TDO1022A, TDO1042AE 40GHz: TDO1042A, TDO2042A, TDO1062A, TDO2062A, TDO1102A, TDO2102A, 50GHz: TDO1062B, TDO2062B, TDO1102B, TDO2102B, TDO1202B, TDO2202B
Memory Depth	4kpts:
Vertical resolution	8 bits
Sample mode	Normal, Average, Peak Detect
Autoset	Finds and displays all active channels, sets edge trigger mode on lowest channel, set vertical sensitivity on scope channels and time base to display one or five periods. Requires minimum voltage >10mVpp, 0.5% duty and minimum frequency >50Hz.

# Specifications and Characteristics

---

## Display system

Display	5.7-inch(145mm) diagonal STN LCD.
Resolution	240 vertical by 320 horizontal pixels
Colour	TDO1000 series: Black and White TDO2000 series: 256 VGA colours
Brightness	Adjustable
Language	Simplified Chinese, Traditional Chinese, English
Display area	Menu ON: 8 vertical by 10 horizontal divisions or 200 vertical by 250 horizontal pixels Menu OFF: 8 vertical by 12 horizontal divisions or 200 vertical by 300 horizontal pixels
Display mode	Vector, Dots
Interpolation	Sinx/x, Linear
Persistence	OFF, Infinite persistence

# Specifications and Characteristics

---

## Power and environmental requirements

Line voltage Range	Max. 99V to 242VAC
Line frequency	Max. 47Hz to 440Hz
Power consumption	Less than 50VA
Operating temperature	5°C to 40°C
Non-operating temperature	-20°C to 55°C
Humidity	Maximum relative humidity 80% for temperatures up to 31°C decreasing linearly to 50% relative humidity at 40°C
Operating altitude	≤2000m
Non-operating altitude	≤15000m

## Physical size and Weight

Instrument height	147 mm
Instrument width	310 mm
Instrument depth	269 mm
Compartment height	57 mm
Compartment width	225 mm
Compartment depth	189 mm
Net weight	Approximately 3.6kg

## Calibration interval

Recommended calibration interval	One year
----------------------------------	----------