

OPERATION MANUAL

TH1776 Inductance Bias Current Source

CONTENTS

CHAPTER 1 OVERVIEW	2
1.1 FOREWORD.....	2
1.2 CONDITION	2
1.2.1 Power ⚠ ⚡.....	2
1.2.2 Temperature and humidity.....	3
1.2.3 Warm-up.....	3
1.2.4 Attention⚠.....	3
1.3 DIMENSION AND WEIGHT.....	3
1.4 SAFETY REQUIREMENT	3
1.5 ELECTROMAGNETIC COMPATIBILITY	4
CHAPTER2 PANEL INSTRUCTION.....	5
2.1 FRONT PANEL	5
2.2 REAR PANEL	6
CHAPTER 3 OPERATION INSTRUCTION.....	7
3.1 20A SYSTEM	7
3.2 40A SYSTEM	8
3.3 TH2828/A/S OPERATION LIMIT	9
3.4 BASIC TEST STEP.....	10
3.5 EXAMPLE OF INDUCTANCE TEST	12
3.6 DC BIAS CURRENT LIST SWEEP.....	20
3.7 REMOTE CONTROL.....	20
CHAPTER 4 PERFORMANCE TEST	21
4.1 DC BIAS OUTPUT CURRENT, VOLTAGE.....	21
FIGURE 4-2 TEMPERATURE ADDITIONAL ERROR.....	21
4.2 TH1776 TEST ACCURACY	21
4.3 TH17761 ADDITIONAL ERROR	23
4.4 EXAMPLE OF CALIBRATING TEST ERROR	28
CHAPTER 5 PACKAGE AND WARRANTY	31
5.1 PACKAGE.....	31
5.2 WARRANTY	32

Chapter 1 Overview

Thank you for choosing the product of our company. The contents of the shipment should be as listed in the packing list. If the contents are incomplete, if there is mechanical damage or defect, or if the instrument does not pass the power-on self tests, please notify our company.

1.1 Foreword

The manual gives an example of connecting TH2828 series and TH1776 to build a AC/DC superposition test system. If other models of LCR can support the online control to TH1776, then the manual can be referred .

TH1776 Inductance Bias Current Source provides 0~20A constant current output, and can be connected with TH2828/A/S instruments of our company. All settings of test condition including the current setting are operated on the front panel of TH2828/A/S. It is suitable for the AC/DC superposition test of magnetic inductors, so it provides the convenient and practical magnetization current source for the magnetic material.

The current of TH1776 0.01A~20A is divided into 3 ranges, and superposition of two TH1776 can provide 40A at most.

After TH2828/A/S instrument is connected with TH1776, it will generate 1% additional errors when the frequency is 1kHz~2MHz, and the test function can also be limited, such as range, and DC bias function.

1.2Condition

1.2.1 Power

Voltage: 220V (1±10%)/110V (1±10%)

Frequency: 50Hz/60Hz (1±5%)

Consumption: ≤600VA

1.2.2 Temperature and humidity

Normal temperature: 0°C~40°C, humidity: < 90%RH

Reference temperature: 20°C±8°C, humidity: < 80%RH

Transportation temperature: 0°C~55°C, humidity: ≤ 93%RH

1.2.3 Warm-up

A little warm up after turning on the instrument

1.2.4 Attention

- Please do not operate the instrument in the place that is vibrative, dusty, under direct sunlight, or where there is corrosive air.
- Although the instrument has been specially designed for reducing the noise caused by ac power, a place with low noise is still recommended. If this cannot be arranged, please make sure to use power filter for the instrument.
- Please store the instrument in the place where temperature is between 5°C and 40°C, humidity is less than 85% RH. If the instrument will not be put in use for a time, please have it properly packed with its original box or a similar box for storing.

1.3 Dimension and weight

width×height×depth: 430*185*473 (mm.³)

weight: 18Kg

1.4 Safety requirement

The instrument is I class safety instrument

(1) Insulation resistance

Under the reference working condition, the insulation resistance between the power terminal and jacket is no less than 50MΩ;

Under the muggy transportation environment condition, the insulation resistance between the power terminal and jacket is no less than 2MΩ;

(2) Insulation intensity

Under the reference working condition, 1.5kV rated voltage can be hold between power terminal and jacket, and the instrument can hold the AC voltage with the frequency of 50Hz for 1 min with out the phenomenon of arcing.

(3) Leakage current

No more than 3.5mA

1.5 Electromagnetic Compatibility

(1) Power transience sensitivity accords to GB6833.4.

(2) Conduction sensitivity accords to GB6833.6.

(3) Radiation interference accords to GB6833.10.

Chapter2 Panel instruction

2.1 Front panel

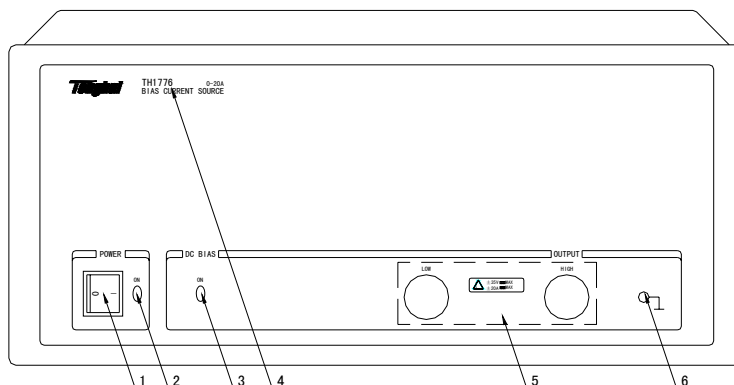

Figure 2-1 Front panel

(1) Power

When the switch is on “I”, connect the power; when the switch is on “O”, cut off power.

(2) Indicator

The power indicator is light after the instrument is turned on, but when the connection between TH17761 and TH1776 is cut off, then the power will be off automatically, meanwhile, LED light is put out, move the switch to “O”, then restart the instrument again.

(3) DC Bias current output indicator

DC bias current output indicator is light in current output and put out in the output end.

(4) Brand and model

(5) DC Bias current output terminal

Being used to output DC current and test the connection status of TH17761 fixture box.

(6) Ground

The ground terminal is connected with shell, being used to connect the ground terminal

2.2 Rear panel

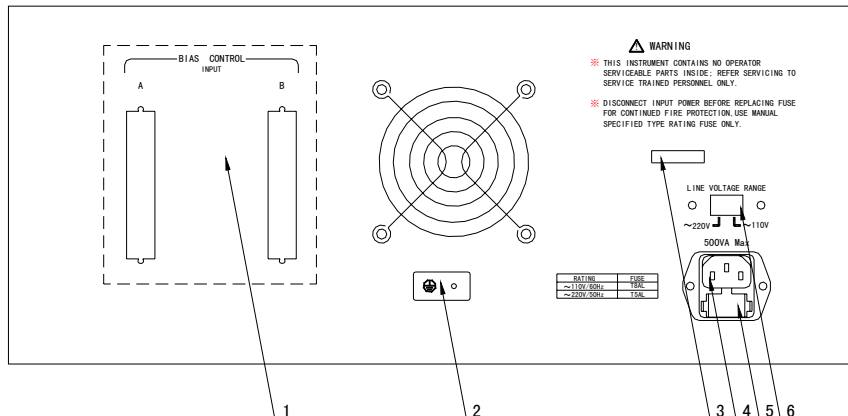

Figure 2-2 Rear panel

1) Bias current interface

Use bias current interface cable to connect TH2828/A/S instrument and the bias current interface A or B of, the other interface is used for 40A system.

2) Ground symbol ⚠

If there is no ground in power line or the ground is unreliable, please connect the ground line here.

3) Nameplate

Information about the series number and manufacturer .etc.

4) Power socket ⚠

Be used to input AC power. Please use 3-core ground power

5) Fuse holder ⚠ ⚡

Be used to install power fuse holder and protect the instrument.

220V 5A/110V 8A fuse is adopted.

6) Voltage selection switch (110V/220V) ⚠ ⚡

Input voltage range switch, to make the instrument match with power and voltage.

Chapter 3 Operation instruction

When TH1776 is connected with TH2828/A/S instrument, there are two configurations. One is 20A bias current system, and the other is 40A bias current system. Meanwhile, some function of TH2828/A/S will be limited.

3.1 20A system

The devices of 20A system:

TH2828/A/S instrument	1
TH1776	1
TH17761 Test box	1
TH26042 Bias current interface cable	1
TH26004E-1 Bias current source link cable	1
TH11761-01 (Bias current interface cable)	1
TH11761-02 (Bias current interface cable)	1
TH11761-03 (Ground line)	1

Connection

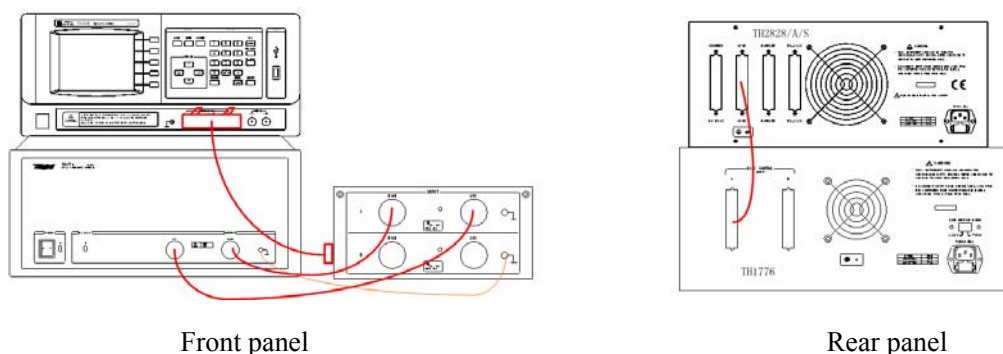

Figure 3-1 20A instrument connection

As figure 3-1 show, connect TH2828/A/S, TH1776 and TH17761 according to the following steps

1. Use bias interface cable to connect the bias current interface of TH2828/A/S instrument and bias current control input interface A of TH1776
2. Use TH17761-01、TH17761-02 (Bias current interface cable) to connect 20A interface of TH1776 and TH17761
3. Use TH17761-03 (ground line) to connect the ground terminal on TH1776 front panel and the ground terminal of TH17761

4. Use TH26004E-1 to connect the test terminal of TH2828/A/S and TH17761

3.2 40A system

Devices of 40A

TH2828/A/S	1
TH1776	2
TH17761 Test box	1
TH26004E-1 Bias current source link cable	1
TH11761-01 (Bias current interface cable)	2
TH11761-02 (Bias current interface cable)	2
TH11761-03 (Ground line)	2
TH26042 Bias current interface cable	2

Connection

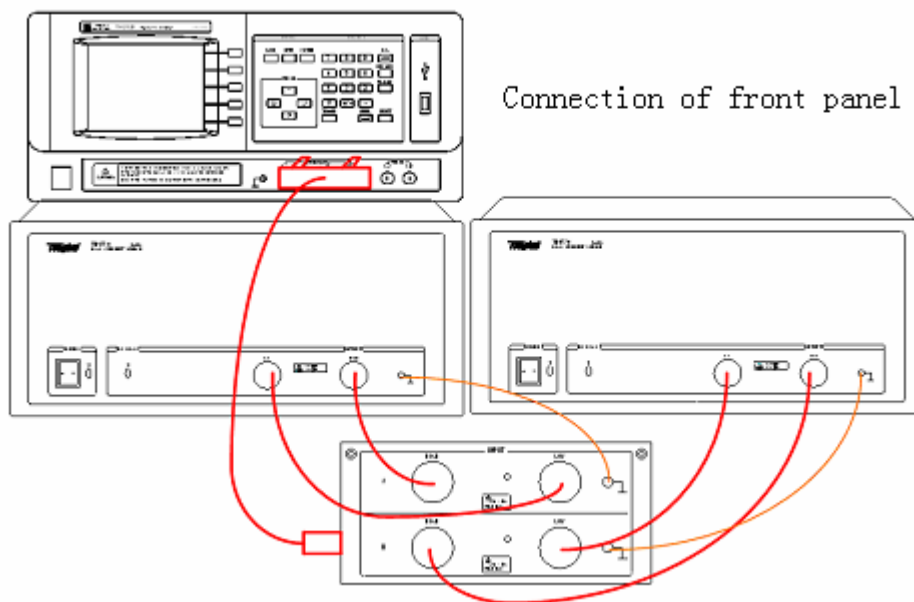

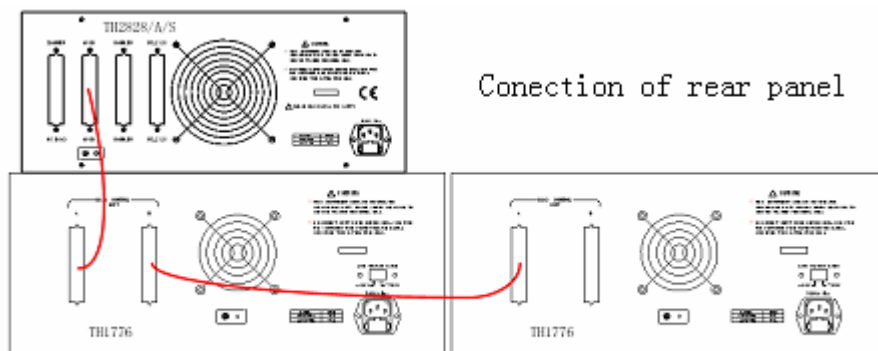

Figure 3-2 40A instrument connection

As figure 3-1 show, connect TH2828/A/S, TH1776 and TH17761 according to the following steps

1. use bias current interface cable to connect the bias current interface of TH2828/A/S bias current control input interface A of TH1776(1)
2. according to step1, connect the bias current control input interface B of TH1776(1) and bias current control input interface A of other TH1776(2)
3. use TH17761-01、TH17761-02 (bias current cable) to connect 20A interface of TH1776 (1) and TH17761.
4. use TH17761-01、TH17761-02 (bias current cable) to connect 40A interface of TH1776 (2) and TH17761
5. use TH17761-03 (ground line) to connect the ground terminal on TH1776 front panel and ground terminal of TH17761
6. use TH26004E-1to connect the test terminals of TH2828/A/S and TH17761

⚠ Warning: In 40A system configuration shown in figure3-2, please don't turn off TH1776 independently or pull out the bias current interface cable. If 40A system is changed to 20A system, TH1776 must be cut off completely, and pullout bias current interface cable, bias current cable and ground line.

3.3 TH2828/A/S operation limit

- Standard point bias (1.5V or 2V) is unavailable
- Optional 001, power amplifier/DC bias is unavailable, so high voltage mode and DC current isolation is turned off, and the Max. oscillation level is limited at 2V, $\pm 40V$ DC bias is forbidden.
- Test range is limited between 10 Ω and 100 Ω

- Open compensation is unnecessary when using TH1776
- The length of test cable is set as 1m

3.4 Basic test step

After the connection of TH2828/A/S and TH1776, the test step is the same as the operation of using TH2828/A/S independently, and all test conditions can be set by the keys on the front panel of TH2828/A/S.

When TH2828/A/S connects 1 (or 2) TH1776, bias current from 0.01A to 20A (or 40A) can be set in the bias area of measurement display page or on measurement setup page. Detailed operation step of TH2828/A/S can refer to the manual of TH2828/A/S.

ⓘAttention: TH1776 will turn off input automatically when TH1776 is tested to be non-connected, so please connect TH1776 firstly before turning on the instrument.

Test step:

1. Check if TH2828/A/S has installed bias current interface control plate.
2. Set test condition
3. Make error calibration
4. Connect the DUT to the test terminal of TH17761
5. Press“DC BIAS”, to output DC current
6. Test the parameter of DUT
7. Press“DC BIAS”, turn off DC current output

(1) Confirm system condition

Make sure that the bias current interface control plate of TH2828/A/S has been installed.

(2) Set test condition

Set test parameter, frequency, signal level, DC bias current, time, all parameters can be set by keys on the front panel of TH2828/A/S, detailed information can refer to the manual of TH2828/A/S.

(3) Make error calibration

Cable length calibration, just as the description of operation limit, the length of the cable used to connect TH2828/A/S and TH1776 is 1m, use TH26004E-1 to connect TH2828/A/S and TH17761.

ⓘAttention: If lead of DUT is too short to connect the test terminal or the

impedance of DUT is less than $50\mu\text{H}$, so use the lead to prolong the test terminal before short test.

(4) Open calibration

Just as the description of operation limit, when TH2828/A/S and TH1776, no need to use 不必 open calibration, turn off open calibration.

(5) Short calibration

Use TH17761-04 short plate to make calibration. When testing low-inductance device, because there is remaining impedance in fixture, the short calibration can eliminate the error, which is very important. If use the prolong line to connect DUT according to the description of “prolong test terminal”, the test line should be unfolded to reach the accurate measurement.

- a、 Loosen TH17761test terminal knob
- b、 Use short plate to connect Hi-Low terminal
- c、 Wind test terminal knob
- d、 Make short measurement

(6) Turn on calibration data

The operation of turning on calibration data is the same as loading calibration data of TH2828/A/S.

(7) Connect DUT to test fixture

Connect DUT to the test terminal of TH17761test fixture

ⓘAttention: When testing open-circle magnetic circuit device , the test impedance will be a little different in different connected directions. If the outlet terminal of device is not enough to connect the test terminal, please refer to the description of “prolong test terminal”

⚠Warning: Due to the consumption of DUT, the test terminal and adjacent area will be hot, so be careful to change DUT.

(8) Turn on DC bias output

Press “DC BIAS” on the front panel of TH2828/A/S, turn on DC bias, DC bias On/Off indicator in TH1776 will be light.

⚠Warning: After TH1776 is connected to TH17761, there will be voltage in the unused bias current input terminal, and use a black protective cap to cover the unused

bias current input terminal of TH17761, don't insert the conductor into the current input terminal of TH17761.

(9) Test DUT

In the process of the DC bias current switch, TH2828/A/S delays measurement automatically. After the DC bias current is stable, TH2828/A/S will continue test automatically. The test result will display on the screen on the basis of the selectable display page.

Under the following circumstances, the DC bias current will be turned off automatically when the test is in process.

- a、 TH1776 DC current source terminal over load
- b、 TH17761 counter electromotive force protective circuit is invalid
- c、 Fixture-testing conductor open

(10) Turn off DC bias output

At the end of test, DC bias current still flow through DUT, then press "DC BIAS" on the front panel of TH2828/A/S to turn off DC bias, in order to avoid the overheat of DUT. DC bias On/Off indicator of TH1776 is put off.

⚠Warning: When DC bias current flows through an open sensitivity circuit, there will be high voltage, the stored energy is proportional to the square of current. Turn off bias current then remove the DUT.

Prolong test terminal

If the conductor of DUT can't connect to the test terminal of TH17761, use a crocodile clip to prolong a suitable length. The Max. lasting current that flows through a conductor safely is limited by the temperature of the conductor. Pay attention to the carrier current ability of the conductor.

3.5 Example of inductance test

This section gives an example of testing inductance by connecting TH2828/A/S and TH1776.

- ◆ DUT: 600 μ H inductance
- ◆ Condition:
 - Function: Ls-Q
 - Frequency: 100 kHz
 - Level: 1V

DC bias current: 20A
 Time: Long
 Length: 1m
 Short calibration: ON

- 1、 TH2828/A/S and TH1776 start up
- 2、 Set test condition on the test display of TH2828/A/S and test setup page.
 - a、 move cursor to function area

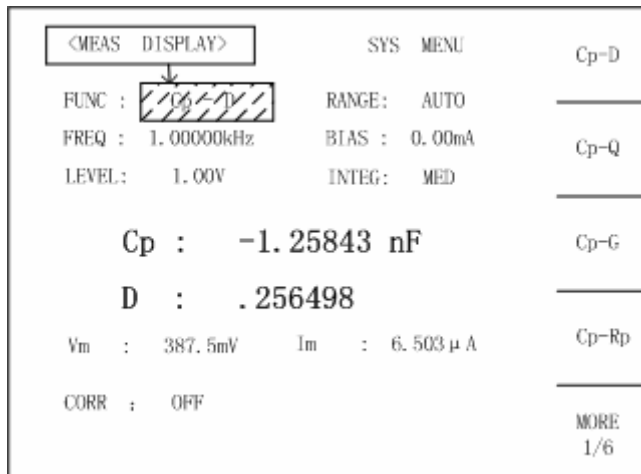

- b、 press" MORE X/6"3 times to select Ls-Q function

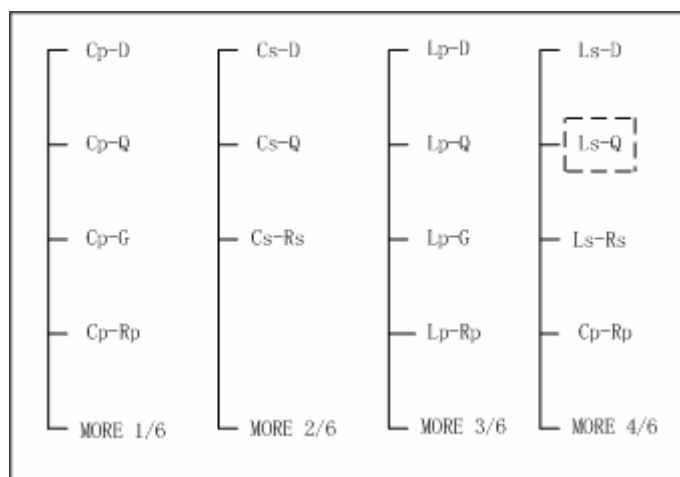

- c、 Move cursor to frequency area, the current display frequency is not 100kHz in test condition

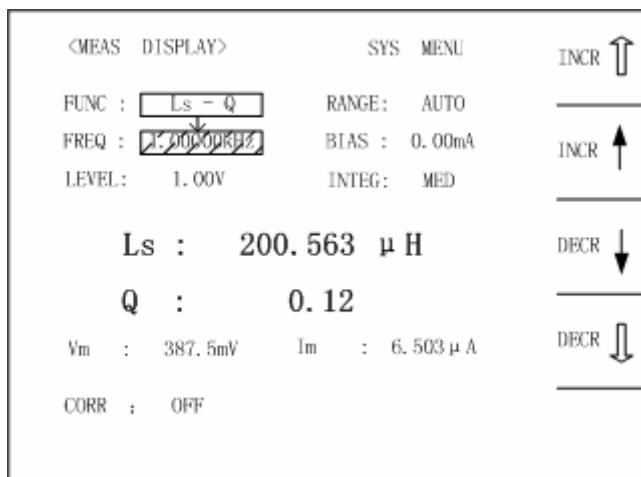

- d、 Press numeric key 1, 0, 0, then 100 is displayed in system message 100, meanwhile the corresponding softkeys will become useful unit selection keys press“kHz”, 100.000kHzwill display in frequency area.

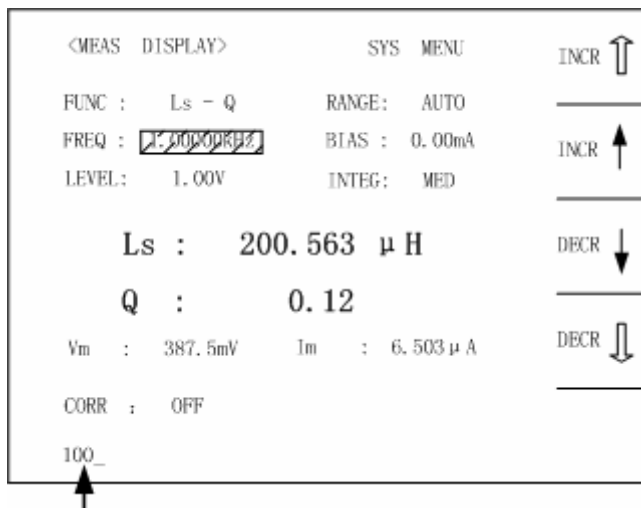

ⓘAttention: When the cursor is in the frequency area, “INCR”or“DECR”can also be used to select the demand frequency.

- e、 Move cursor to bias area, 0.00mA is displayed on the screen.

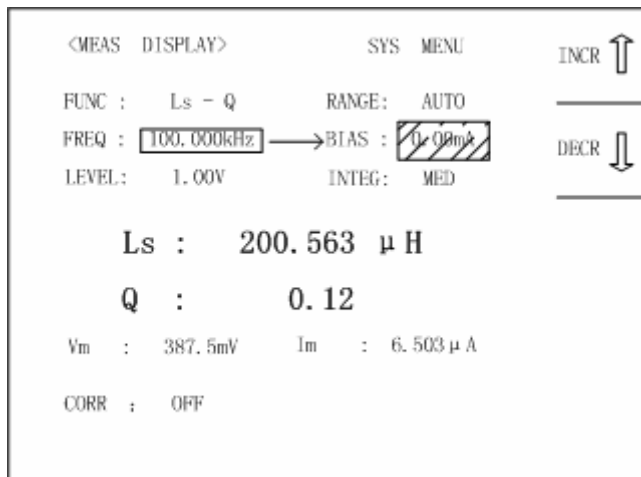

f、 Press 2, 0, 20 is in system message, meanwhile softkeys is changed to corresponding units, press "A", 20A will be displayed in bias area.

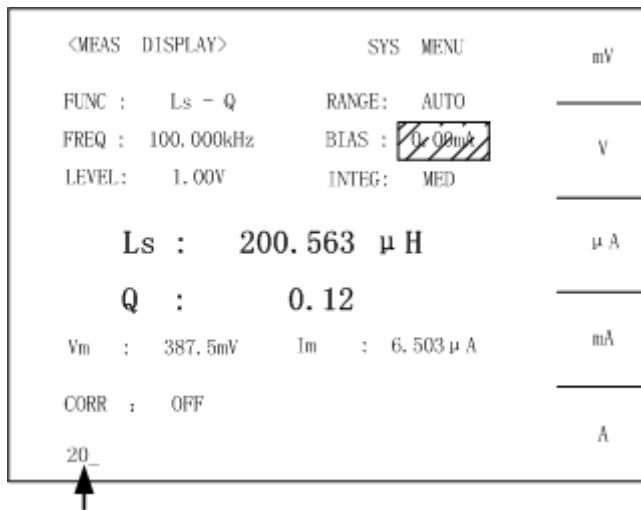

g、 Move cursor to time are, the current display is MED. In softkey area, the display is SHORT、MED、LONG

h、 Press "LONG" to select LONG time

<MEAS DISPLAY>	SYS MENU	SHORT
FUNC : Ls - Q	RANGE: AUTO	SHORT
FREQ : 100.000kHz	BIAS : 20.00A	MED
LEVEL: 1.00V	INTEG:	MED
Ls : 200.563 μ H		LONG
Q : 0.12		
Vm : 387.5mV	Im : 6.503 μ A	
CORR : OFF		

ⓘAttention: Test condition can be set on the test setting page, press “MEAS SETUP” to enter setup.

i. Press “MEAS SETUP” to enter test setting page

<MEAS DISPLAY>	SYS MENU	LOAD
FUNC : Ls - Q	RANGE: AUTO	CLEAR
FREQ : 100.000kHz	BIAS : 20.00A	SETUP
LEVEL: 1.00V	INTEG: LONG	
TRIG : INT	AVG : 1	
ALC : OFF	Vm : ON	
Hi-Pw: OFF	Im : ON	
DCI : ISO OFF	DELAY : 0ms	STORE
DEV A : OFF	REF A : 0.00000F	MORE
B : OFF	B : 0.00000	1/2

j、 Move cursor to ALC area, the current ALC status is OFF, and the softkey area is changed to ON, OFF.

<MEAS DISPLAY>		SYS MENU	ON
FUNC :	Ls - Q	RANGE: AUTO	_____
FREQ :	100.000kHz	BIAS : 20.00A	OFF
LEVEL:	1.00V	INTEG: LONG	_____
TRIG :	INT	AVG : 1	_____
ALC :	OFF	Vm : ON	_____
Hi-Pw:	OFF	Im : ON	_____
DCI : ISO	OFF	DELAY : 0ms	_____
DEV A :	OFF	REF A : 0.00000F	_____
B :	OFF	B : 0.00000	_____

k、 Press ON, level area will display “*”

<MEAS DISPLAY>		SYS MENU	ON
FUNC :	Ls - Q	RANGE: AUTO	_____
FREQ :	100.000kHz	BIAS : 20.00A	OFF
LEVEL:	* 1.00V	INTEG: LONG	_____
TRIG :	INT	AVG : 1	_____
ALC :	ON	Vm : ON	_____
Hi-Pw:	OFF	Im : ON	_____
DCI : ISO	OFF	DELAY : 0ms	_____
DEV A :	OFF	REF A : 0.00000F	_____
B :	OFF	B : 0.00000	_____

3、 Execute short calibration

In order to compensate the test error caused by TH17761 remained impedance, the instrument needs to be made short calibration. Press “MEAS SETUP” and “CORRECTION” to enter calibration interface.

a、 Move cursor to cable area to display the current cable length, and the softkeys are changed to 0m, 1m, 2m and 4m

- b、 Press “1m” to select the cable length as 1m

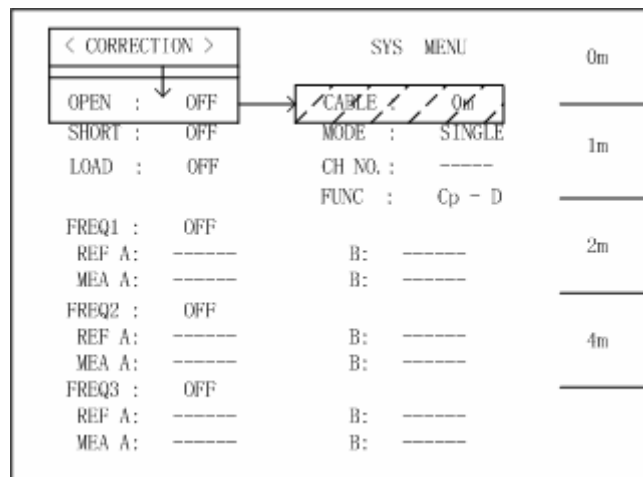

- c、 Use short bar to connect the test terminal of TH17761
 d、 Move cursor to short area, and the sofkeys is changed to ON, OFF, MEAS SHORT

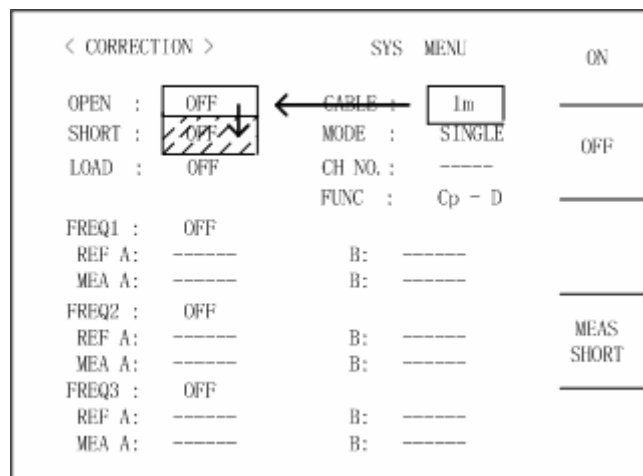

- e、 Press“MEAS SHORT” to make short calibration, after executing, “SHORT measurement completed” will be displayed in message.
 f、 Press ON to open short calibration.

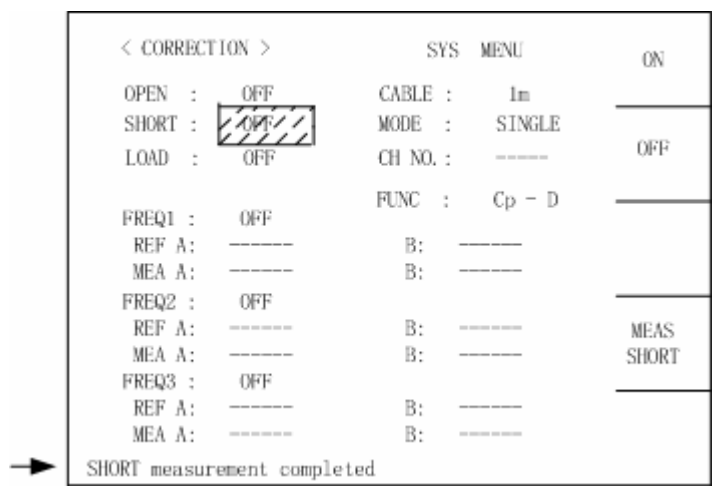

ⓘ Attention: In point frequency measurement, point frequency short calibration function can be used to execute the appointed frequency soon.

- 4、 Connect DUT to test fixture
Connect DUT to the test terminal of TH17761.
- 5、 Turn on DC bias output
Press “DC BIAS” on the front panel of TH2828/A/S to turn on DC bias. DC bias indicator of TH1776 is light.
- 6、 Execute measurement
Press “DISP FORMAT”, test value will display on the screen.

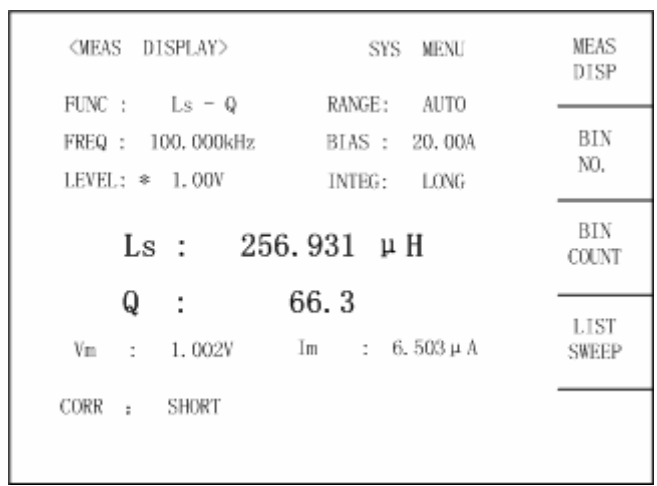

- 7、 Turn off DC bias output
At the end of measurement, press DC BIAS to turn off output. TH1776 DC bias

indicator is put off.

3.6 DC bias current list sweep

List sweep function of TH2828/A/S allows to set 10 frequency, level or DC bias voltage, when connecting with TH1776, DC bias current can also be set. The table fellow is an example of DC bias current list sweep.

<LIST SWEEP DISPLAY>		SYS MENU		MEAS DISP
MODE :	SEQ			
BIAS[A]	Ls[H]	Q[]	COMP	BIN NO.
10mA	606.781 μ	87.9		
1A	604.214 μ	84		
5A	527.269 μ	80		BIN COUNT
10A	411.967 μ	71		
20A	262.351 μ	65		LIST SWEEP

ⓘ Attention: At manual trigger mode, list sweep function can store the last test condition, set OA at last test point to avoid the overheat of DUT.

3.7 Remote control

TH1776 can be controlled by TH2828/A/S through bias current interface, when TH2828/A/S is connected with TH1776, other remote control can be available except the limits in "operation limit".

The following are the remote control orders controlling TH1776

BIAS: STATE ON (1)	turn on DC bias current
BIAS: STATE OFF (0)	turn off DC bias current
BIAS: STATE?	Query DC bias current status
BIAS: CURRent <value>	set DC bias current value
BIAS: CURRent?	Query DC bias current value
BIAS: CURRent MAX	set max. DC bias current value
BIAS: CURRent? MAX	query max. DC bias current value
BIAS: CURRent MIN	set min. DC bias current value
BIAS: CURRent? MIN	query min. DC bias current value

Chapter 4 Performance test

4.1 DC bias output current, voltage

TH1776 can output current from 0.00A to 20.0A, dividing into 3 ranges.

Range	Resolution	Accuracy
0.00A~1.00A	0.01A	$\pm (1\%+5mA)$
1.1A~5.0A	0.1A	$\pm 2\%$
5.1A~20.0A	0.1A	$\pm 3\%$

Figure 4-1 DC bias current accuracy

Temperature (°C)	0	8	18	28	38	55
Add. error	1.5%	0.5%	0%	0.5%	1.5%	

Figure 4-2 Temperature additional error

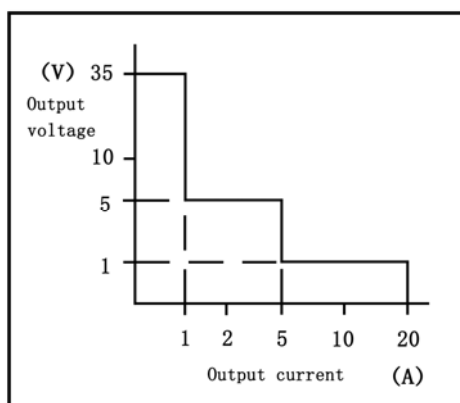

Figure 4-3 DC bias output range

4.2 TH1776 test accuracy

When TH2828/A/S is connected with TH1776、TH17761, the test range of TH2828/A/S is limited at 10Ωand 100Ω, L、| Z |、Rs、D、θ:

Accuracy of **L** and **| Z |** : Ae (accuracy of L; $Dx \leq 0.1$)

$$Ae = A0 + A1 \quad [\% \text{ reading}]$$

A0: is the accuracy of L and | Z | when TH2828/A/S is connected with TH1776, the selection of A0 is shown as figure 4-4, select a suitable accuracy line in figure 4-5. If the signal is not the 3 point listed in figure 4-5, prolong the two lines closing to signal to confirm the demanded accuracy.

A1 : TH1776 additional error

Dx : D test value

If $Dx > 0.1$, accuracy of L is $A1 \sqrt{1 + D_x^2}$

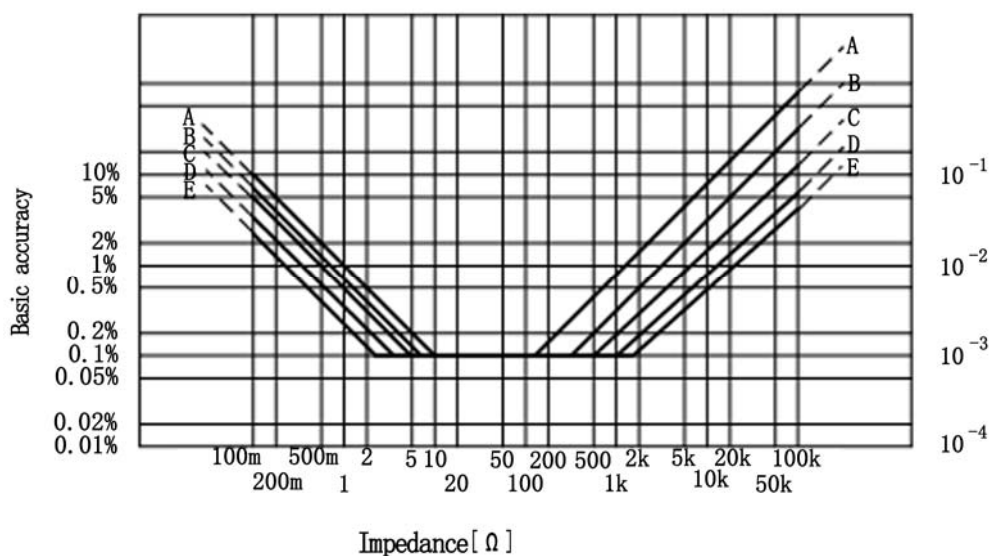

Figure 4-4 TH2828/A/S accuracy

Test Signal Voltage	Temperature (°C)					
	5	8	18	28	38	45
0.5Vrms	A	B	C	B	A	
1Vrms	B	C	D	C	B	
2Vrms	C	D	E	D	C	

Figure 4-5 TH2828/A/S basic accuracy line selection table

D accuracy: De (Dx ≤ 0.1)

$$De = \frac{A_e}{100}$$

Ae : test accuracy of L and | Z |

D_x : Test value of D

When $D_x > 0.1$, accuracy of D is $D_e \sqrt{1 + D_x}$

θ accuracy: θ_e

$$\theta_e = \frac{180 \times A_e}{\pi \times 100} [^\circ]$$

Rs accuracy: R_{se} ($D_x \leq 0.1$)

$$R_{se} = 2 \pi f L_x \times D_e [\Omega]$$

f : Frequency [Hz]

L_x : Inductance [H]

D_e : Test accuracy D

4.3 TH17761 additional error

As for the accuracy of TH2828/A/S, the test accuracy of TH1776 stands for the tolerance of additional error, if the following conditions are fulfilled, the accuracy of TH1776 can be applied at TH17761 test terminal

- TH2828/A/S integration time: LONG
- Test signal voltage: 1Vrms
- Cable length: 1m
- Temperature: $23^\circ\text{C} \pm 5^\circ\text{C}$
- $D < 1$

Additional error of L and $|Z|$ (accuracy of L; $D_x < 0.1$)

Accuracy of L and $|Z| A_1$, can be read from figure 4-2 according to the test condition and system configuration.

D_x : D test value

When $0.1 \leq D_x < 1$, accuracy of L is $A_1 \sqrt{1 + D_x^2}$

When the temperature is $5^\circ\text{C} \sim 45^\circ\text{C}$, the value of A_1 needs to be added the temperature additional error of figure 4-8 or figure 4-11

Table 4-1 Accuracy selection table

	20A configuration	40A configuration
L—D, R_s	Figure 4-6	Figure 4-9
$ Z - \theta$	Figure 4-7	Figure 4-10
Temperature additional error	Figure 4-8	Figure 4-11

D additional error: D1 (Dx < 0.1)

$$D1 = \frac{A_1}{100}$$

Dx : D test value

When $0.1 \leq Dx < 1$, the accuracy of D is $D1 \times (1 + Dx)$

⊖ additional error: θ 1

$$\theta 1 = \tan^{-1} D1 [^\circ]$$

D1 : Additional error of D

Rs additional error: Rs1 (Dx < 0.1)

$$Rs1 = 2 \pi f Lx \times D1$$

Lx : Inductance [H]

D1 : D additional error

Dx : Value of D

f : Frequency

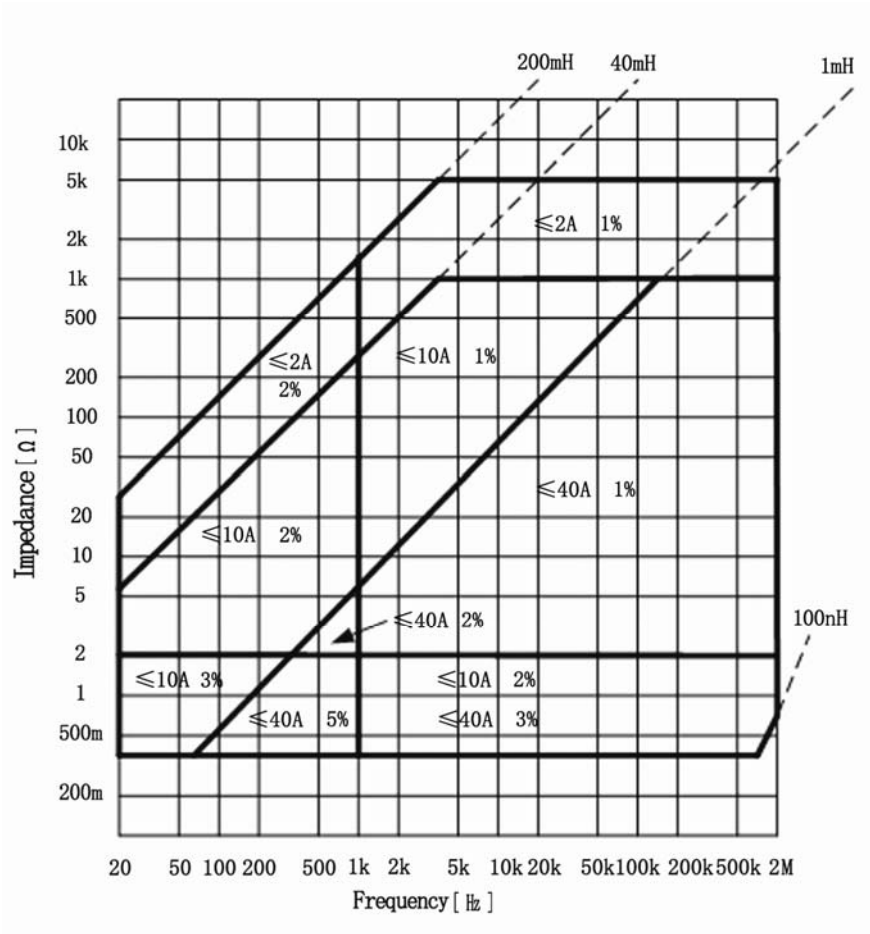

Figure 4-6 TH1776 inductance test accuracy (20A configuration)

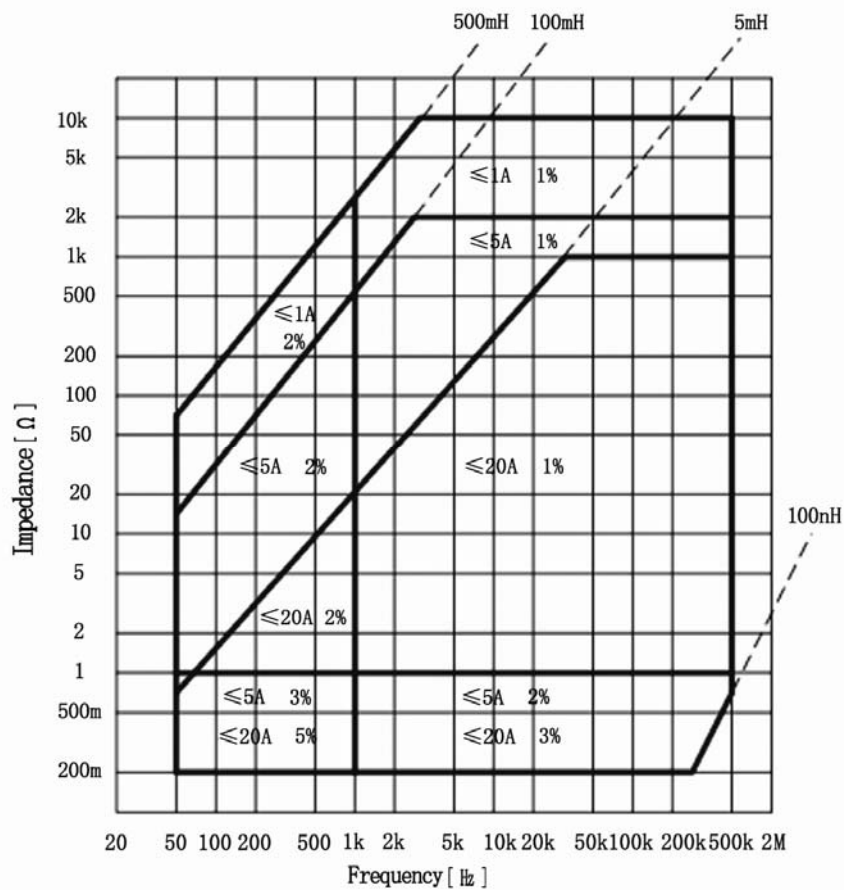

Figure 4-7 TH1776 impedance test accuracy (20A configuration)

Temperature (°C)	5	8	18	28	38	45
Add. error		2%	1%	0%	1%	2%

Figure 4-8 TH1776 temperature additional error (20A configuration)

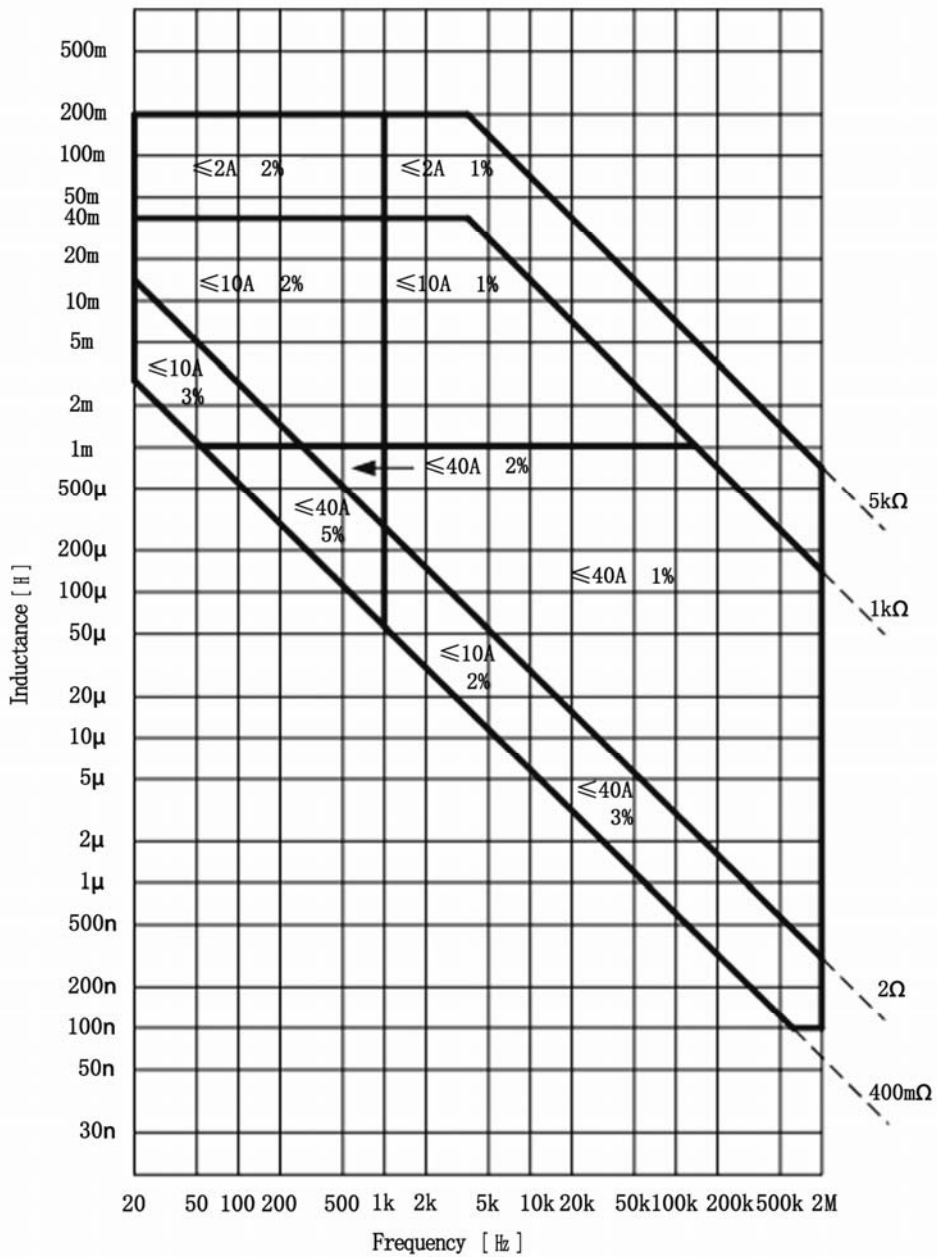

Figure 4-9 TH1776 inductance test accuracy (40A configuration)

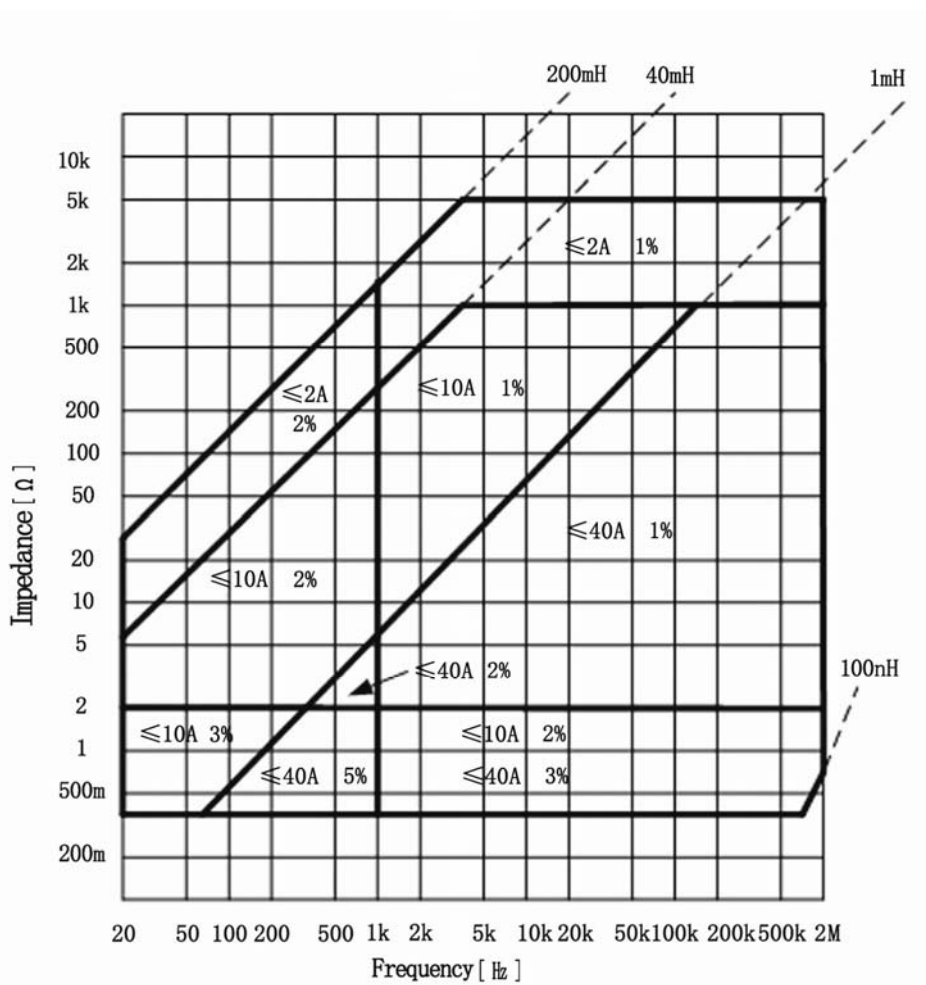

Figure 4-10 TH1776 impedance test accuracy (40A configuration)

Temperature(°C)		5	8	18	28	38	45
Add error	Ibias ≤10[A]	3.0%	1.5%	0%	1.5%	3.0%	
	Ibias ≤40[A]	4.0%	2.0%	0%	2.0%	4.0%	

Figure 4-11 TH1776 temperature additional error (40A configuration)

4.4 Example of calibrating test error

Instruct the test accuracy of Ls—Rs by an example below

Condition:

- DUT: 10mH
- Signal level: 1Vrms
- Test frequency: 1 kHz
- Integration time: LONG
- Short compensation: Execution
- DC bias current: 5A
- Temperature: 28°C

When using TH1776 online, inductance test accuracy of TH2828/A/S A_e and equivalence series resistance accuracy R_e can be expressed by the formula below

$$A_e = A_0 + A_1$$

$$R_e = R_0 + R_1$$

Where A_0 : TH2828/A/S accuracy of L and $|Z|$
 R_0 : TH2828/A/S accuracy of R_s
 A_1 : TH1776 accuracy of L and $|Z|$
 R_1 : TH1776 accuracy of R_s

Step 1

When using TH1776 online, confirm A_0 and A_1 of TH2828/A/S

- (1) The inductance of DUT is 10mH, so its impedance is

$$Z_m = 2\pi f_m L_x \approx 62.8\Omega$$

Where f_m is frequency

- (2) L_x is inductance of DUT
 (3) According to figure 4-5, pick up accuracy line from figure 4-4
 Temperature is 28°C, signal voltage is 1Vrms, so pick up accuracy line D
 (4) Find corresponding impedance along X axial
 (5) Find crossing point of the two steps above
 (6) Read out the vertical coordinate A_0

$$A_0 = 0.10 [\%]$$

$$D_0 = \frac{A_0}{100} = \frac{0.1}{100} = 0.001$$

$$R_0 = 2\pi f L_x \times D_0 = 2\pi \times 1000 \times 0.01 \times 0.001 = 0.063\Omega$$

Step 2

Confirm the additional error L_1 of 42841A

- (1) Pick up accuracy figure from 4-1, and pick up 4-6 L_s — R_s according to 20A configuration and test.
 (2) Pick up frequency along X axial from figure 4-6
 (3) Pick up inductance along Y axial from figure 4-6
 (4) Write the crossing point of the two steps above

- (5) If the value is on the boundary, then L can be confirmed according to the principle that the Max. current in the zone of actual-used DC current rate. Frequency is 1kHz, $L_x=10\text{mH}$, DC bias current is 5A
So $L_1=1$ [%]

Step 3

Confirm the temperature error K1 of TH1776 from figure 4-8

Environmental temperature is 28°C , so

$$K_1=0$$
 [%]

so

$$A_1=L_1+K_1=1+0=1$$
 [%]

$$D_1=\frac{A_1}{100}=\frac{1}{100} 0.01$$

Frequency is 1kHz, $L_x=10\text{mH}$, $D_1=0.01$, so

$$\begin{aligned} R_1 &= 2\pi f L_x \times D_1 \\ &= 2\pi \times 1000 \times 0.01 \times 0.01 \\ &\approx 0.63 \quad [\Omega] \end{aligned}$$

so, when using TH1776 and TH17761, the accuracy of TH2828/A/S is

$$A_e=A_0+A_1$$

$$=0.1+1$$

$$=1.1$$
 [%]

$$R_e=R_0+R_1$$

$$=0.063+0.63$$

$$=0.693$$
 [%]

Chapter 5 Package and warranty

5.1 Package

The contents are listed as follows:

No.	Name	Quantity
1	TH1776 Inductance bias current source	1
2	TH17761 Test box	1
3	TH17761-01 Bias current cable	1
4	TH17761-02 Bias current cable	1
5	TH17761-03 Ground line	1
6	TH17761-04 Short plate	1
7	TH26004E-1 Bias current source link cable	1
8	50-core Bias current interface cable	1
9	3-line power	1
10	Fuse	2
11	Operation manual	1
12	Certificate of Quality	1
13	Test report	1
14	Warranty card	1

Check the contents when you received the instrument. If the contents are incomplete, if there is mechanical damage or defect, or if the instrument does not pass the power-on self-tests, please contact our company or business department immediately.

◦

5.2 Warranty

The period of warranty: the period of warranty will start from the date the instrument is delivered. The period of warranty is two years. The warranty card is needed when the instrument needs to be repaired. The foregoing warranty shall not apply to defects resulting from improper or inadequate maintenance by Buyer.