OPERATION MANUAL

MODEL **TH2820**

LCR METER

Version 2

Caution

Keeping on turning on and off the instrument is **absolutely forbidden**, as this will cause the disorder of the program, which will lead to the loss of the calibrated data and the data saved by users.

Note

"7.Advanced set" in the setup menu should only be operated by the qualified calibration personnel, therefore, this function is password protected. Even if you know the password, you should also take high cautions when choosing to use the options. Any wrong operations may lead to the incorrect test results!

This instrument should be calibrated in the calibration lab in our company.

Options and functions of the instrument may be advanced by our company in order to make the instrument more accurate. Any queries regarding the instrument, please feel free to contact us

Content

- Caution** 2
- Note** 2
- Chapter 1 Summary 4
 - 1** Introduction 4
 - 2** Main features 4
 - 3** Specifications 5
 - 4** Environment 6
- Chapter 2 Panel Overview 7
 - 1** Front Panel 7
 - 2** Rear Panel 8
- Chapter 3 Operation Illustration 9
 - 1** Turning On 9
 - 2** Operation 10
- Chapter 4 Maintenance and Measurement Basic 21
 - 1** Input Protection 21
 - 2** Measurement Contacts 21
 - 3** Stray Capacitance 22
- Chapter 5 Contents and Warranty 24
 - 1** Contents 24
 - 2** Warranty 24

Chapter 1 Summary

Thanks for purchasing our products! Please check the contents according to the last chapter "Contents and Warranty" of the manual before put the instrument in use.

1 Introduction

Model TH2820 LCR meter is a micro desktop instrument by using microprocessor technology. It can measure 6 basic parameters, they are inductance L, capacitance C, resistance R, impedance Z, dissipation factor D and quality factor Q, which can fulfill the measurement needs of various components manufacturers and maintenance technicians.

2 Main features

1. Zero Correction:

- OPEN — sweep correction of open circuit;
- SHORT — sweep correction of short circuit.

2. Display Format:

- Direct — actual measured value ;
- Δ — absolute delta between the measured value and the reference value;
- $\Delta\%$ — delta percent between the measured value and the reference value.

3. Range Hold:

When measuring a large number of components with the same nominal value, this function can effectively improve the measuring speed.

4. Comparator Function:

TH2820's built-in comparator can sort components into a maximum of four bins (NG, P1, P2 and P3).

5. Equivalent Measurement Circuit:

There are two equivalent circuit models: parallel and series.

3 Specifications

Parameters	L-Q, C-D, R-Q, Z-Q and Z-D		
Test Frequency	100Hz, 120Hz and 1kHz		
Display Digits	5 digits for both primary parameters and secondary parameters		
Measurement Range	L	100 Hz, 120 Hz	1 μ H – 9.9999 kH
		1 kHz	0.1 μ H – 999.99 H
	C	100 Hz, 120 Hz	1 pF – 9.9999 mF
		1 kHz	0.1 pF – 999.99 μ F
	R, Z	1 m Ω – 999.99 M Ω	
	D, Q	0.0001 – 99999	
$\Delta\%$	0.0001% – 99999%		
Accuracy (Test Condition: within basic measurement range, 23°C\pm5°C, <75%R.H.)	C : 0.3% (1 + C_x/C_{max} + C_{min}/C_x)(1 + D_x) ; L : 0.3% (1 + L_x/L_{max} + L_{min}/L_x)(1 + 1/ Q_x) ; Z : 0.3% (1 + Z_x/Z_{max} + Z_{min}/Z_x) ; R : 0.3%(1 + R_x/R_{max} + R_{min}/R_x)(1 + Q_x) ; D : $\pm 0.001(1 + Z_x/Z_{max} + Z_{min}/Z_x)(1 + D_x + D_x^2) + 0.0002$; Q : $\pm 0.002(1 + Z_x/Z_{max} + Z_{min}/Z_x)(Q_x + 1/Q_x)$;		
Test signal level	0.3V _{rms} (1 \pm 10%)		
Ranging Mode	Auto, Hold		
Equivalent model	Series, Parallel		
Display	Direct: actual measured value; Δ : absolute delta; $\Delta\%$: delta percent.		
Correction	Open and Short correction		
Test Speed	approx. 3 times/second		
Test Terminals	5 terminals		
Range of Sorting Limits	%		-9999% – +9999%
	Nominal value	L	0.0001 μ H – 99999 kH
		C	0.0001 pF – 99999 mF
		R	0.0001 m Ω – 99999 M Ω
		Z	0.0001 m Ω – 99999 M Ω
Sorting Bins	NG, P1, P2 and P3		
Alarm States	NG, P1, P2, P3 and OFF		
Weight	Around 1.5 kg		
Consumption	Max.10 W		
Power	220VAC (1 \pm 10%) , 50Hz (1 \pm 5%)		

Note:

1. Accuracy of D and Q are delta absolute deviations, the rest are delta percent deviations;
2. Suffix with x is the actual measured value of this parameter, suffix with $_{max}$ is the maximum value, suffix with $_{min}$ is the minimum value;

Parameter	Range Auto	Range Hold				
		Range0	Range1	Range2	Range3	Range4
C_{max}	80 μ F/f	1000pF/f	0.1 μ F/f	1 μ F/f	10 μ F/f	80 μ F/f
C_{min}	150pF/f	150pF/f	1900pF/f	10nF/f	100nF/f	1 μ F/f
L_{max}	159H/f	159H/f	25.3H/f	2.53H/f	253mH/f	25.3mH/f
L_{min}	0.32mH/f	2.53H/f	0.25H/f	25.3mH/f	2.53mH/f	0.32mH/f
Z_{max}	1M Ω	1M Ω	159k Ω	15.9 k Ω	1.59k Ω	159 Ω
Z_{min}	1.59 Ω	15.9k Ω	1.59k Ω	159 Ω	15.9 Ω	1.59 Ω

$$Z_{max} = R_{max}; \quad Z_{min} = R_{min}$$

3. In order to maintain good test accuracy, proper open and short circuit corrections should be taken under current measurement condition and measurement fixture.

4 Environment

1. Please do not operate the instrument under the following environment conditions, as any of them will directly affect measuring precision or damage the instrument:
 - (1) Please do not operate the instrument in the places where is vibrative, dusty, under direct sunlight, or where there is corrosive air.
 - (2) Although the equipment has been specially designed for reducing the noise caused by AC power, a place with low noise is still recommended. If this cannot be arranged, please make sure to use power filter for the instrument.
2. Please store the instrument in the place where temperature is between -25°C and 50°C. If the instrument will not be put in use for a while, please have it properly packed for storing.
3. Operation environment for securing measuring precision requirement:
 - Temperature: 0°C ~ 40°C
 - Humidity : $\leq 85\%$ R.H.
4. Pre-heat the instrument about 10 minutes before starting measuring.

Chapter 2 Panel Overview

1 Front Panel

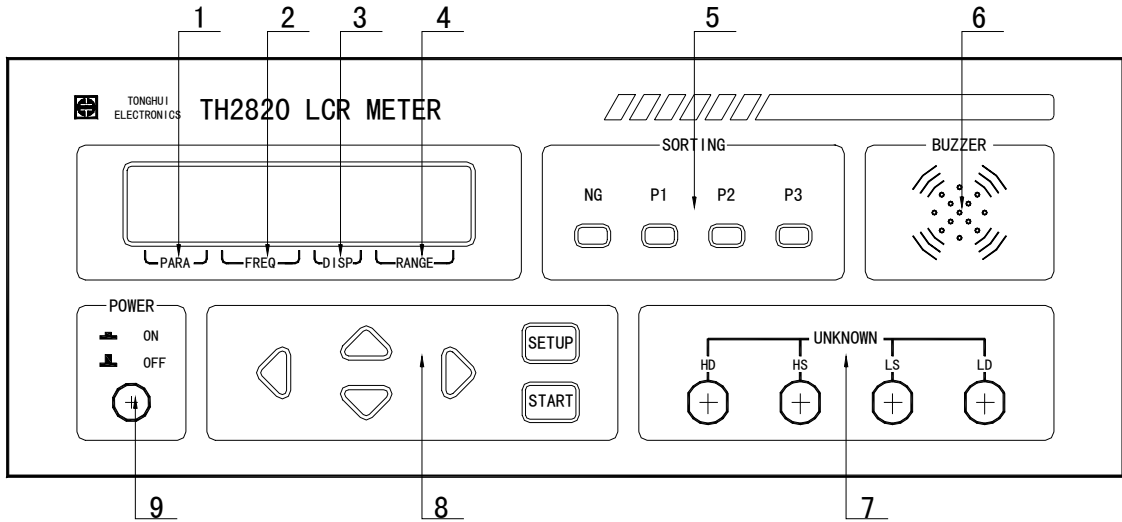

Figure 2-1 Front panel

Following is the description of items 1~9 in Figure 2-1.

No	Name	Description	
1	Parameter	Displaying current measured parameters : L-Q, C-D, R-Q, Z-Q, Z-D or AUTO	
2	Frequency	Displaying current frequency : 100 Hz, 120 Hz or 1 kHz	
3	Display Mode	Displaying current display mode of the primary parameter: DIR, Δ or Δ%	
4	Range	Displaying range state: Auto, Hold or current range.	
5	Bins Indication	NG: No-good; P1: Pass1; P2: Pass2; P3: Pass3; P1, P2, P3 Priority is lower in turn.	
6	Buzzer		
7	Test Terminals	HD, HS, LS and LD	
8	Key	Cursor keys	Function table moving and rolling
		Setup key	Entering function table setting
		Start key	The executing confirmation of command
9	POWER	Power switch	

Table 2-1 Front Panel Descriptions

2 Rear Panel

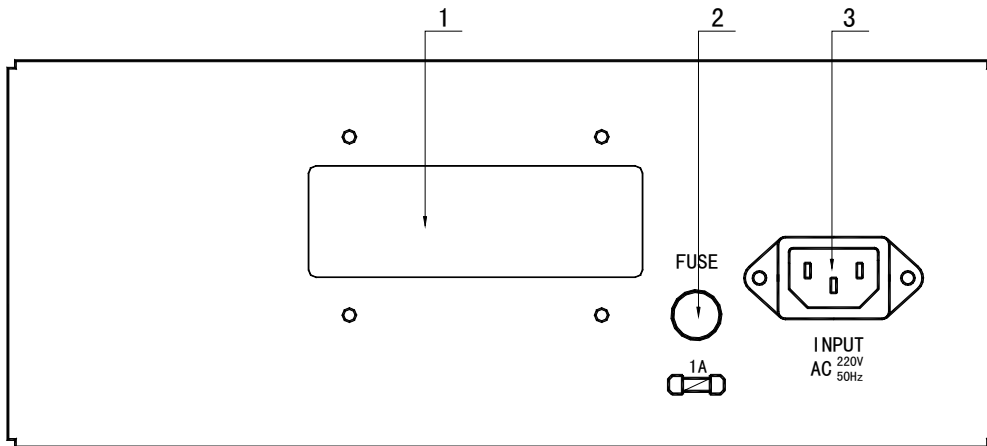

Figure 2-2 Rear panel

Item	Name	Description
1	Plate	Production date, model and serial number
2	Fuse Holder	1A 250 Vac slow blow fuse.
3	Power Receptacle	220 Vac 50 Hz

Table 2-2 Rear Panel Descriptions

Chapter 3 Operation Illustration

This chapter will introduce how to operate this instrument in details, please read it carefully before operating, in order to avoid any damages to the instrument or dangers to the safety.

1 Turning On

- a. Display company name and version, the indicator lamps of P1, P2, P3, NG flash in turn.

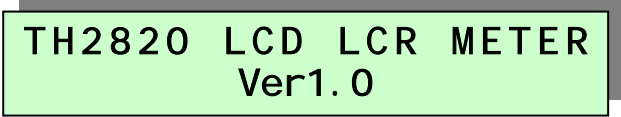

TH2820 LCD LCR METER
Ver1.0

Figure 3-1 Turning on information

- b. Starting power-on self tests

- 1) EEPROM Memory checking
- 2) ADC AD converter checking

- c. Entering measuring state after self tests

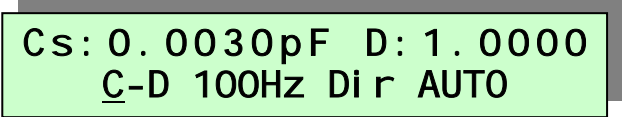

Cs: 0.0030pF D: 1.0000
C-D 100Hz Dir AUTO

Figure 3-2 Measuring state

The factory settings are listed as follows and can be reseted according to the operation description in next paragraph.

- (1) Parameter: C-D;
- (2) Frequency: 100 Hz;
- (3) Display: Dir (direct reading) ;
- (4) Range: AUTO (automation) ;
- (5) Equivalent: SER (serial) ;
- (6) Alarm Bin: P1 (Pass #1) ;
- (7) LCZ automation: OFF;
- (8) Cursor : _

2 Operation

1 Direct function setup — Parameter, frequency, display and range:

- a) Press keys to move the cursor and select one of the four direct functions.
- b) Press keys to select :

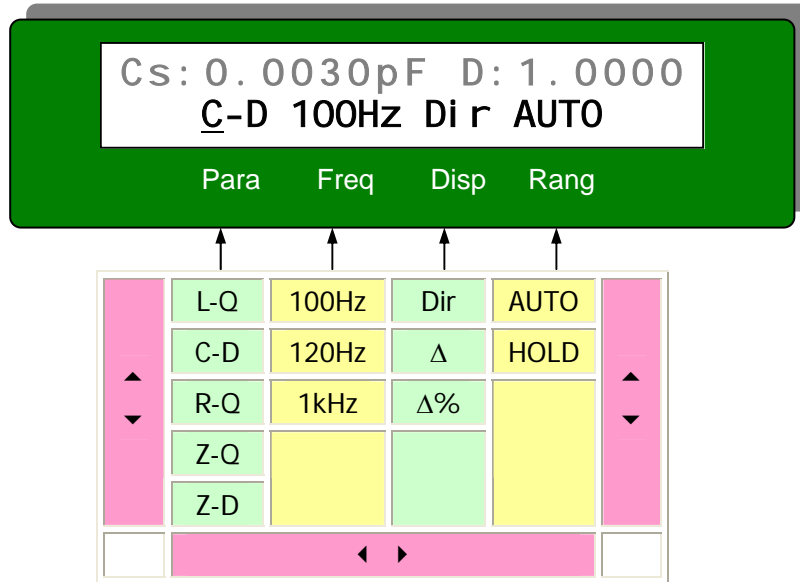

Table 3-1 OSD Direct Function Items

A · Parameter:

Unit descriptions:

L	μH	mH	H	kH
C	pF	nF	μF	mF
R/Z	MΩ	Ω	kΩ	MΩ

Table 3-2 units

1. Z is the absolute value of impedance. Measurement value of L, C or R may be positive or negative. Negative capacitance value means that the device under test is actually an inductor; also negative inductance value means that the device under test is actually a capacitor. In theory R should be positive constantly, under some condition, R maybe negative due to over zero correction. Please carry out correct zero correction.
2. The maximum number of display digits is 5, but 5 digits is not always available and 4 digits is displayed sometimes. The conversion is described in the following table:

Previous display digits	First two digits of current value	Current display digits
4(Bigger first two digits)	<29	5
5(Smaller first two digits)	>32	4

Table 3-3 The conversion of display digits

B · Display mode —— Direct reading (Dir) , Absolute delta (Δ) , Percent delta ($\Delta\%$)

1. (Δ) delta absolute deviation measurement:

$$\Delta = X_x - X_{std}$$

X_x : Measured value X_{std} : reference value

2. ($\Delta\%$) Delta percent deviation measurement:

$$\Delta\% = \frac{X_x - X_{std}}{X_{std}} \cdot 100\%$$

C. Measurement range

1. The instrument has 5 measurement ranges. The measurement range is selected according to the impedance even if measurement parameter is capacitance or inductance.

Range No.	Range resistor	Z up	Z down
0	100k Ω	↑ 32k Ω	↓ 30k Ω
1	10k Ω	↑ 3.2k Ω	↓ 3k Ω
2	1k Ω	↑ 320 Ω	↓ 300 Ω
3	100 Ω	↑ 32 Ω	↓ 30 Ω
4	10 Ω	↑	↓

Table 3-4 Range NO., Range Resistor and Up and Down Limits of Impedance.

2. When measurement range is set to AUTO, the instrument first estimates if current range is the correct range, if it's the correct range, then the instrument calculates and displays the measurement value, otherwise instrument has to change to the correct range and start measurement again. Therefore, in range AUTO mode, one more measurement will be taken if the measurement range has to be changed.

So more time is taken in range AUTO mode.

3. If a large number of devices under test belong to the same range, the correct range can be locked to raise the measurement speed. For the instrument do not have to take any time to find the correct the range.
4. When measurement range is set to HOLD, if the impedance under test exceeds the effective measuring range of the locked measurement range, overload symbols will be displayed as shown in Figure 3-3:

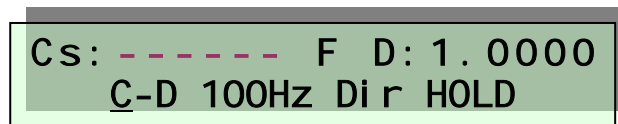

Figure 3-3 Overload

Note: If the measurement value exceeds the display range of the instrument, overload symbols will also be displayed.

5. How to calculate the measurement range

Example: Suppose capacitance $C=210\text{pF}$, dissipation $D=0.0010$ and test frequency $f=1\text{kHz}$.

Solution: We can calculate: $Z_x = 757.9$

From Table 3-4, you can find the correct measurement range is range 2.

2 Indirect Functions Setup:

Indirect functions are Clear "0", Sorting, Auto-LCZ, Buzzer, Change cursor, Advanced set, and State save & exit.

Press **Setup** key to enter the setup menu in measurement state. Pressing **Setup** key again, the instrument returns back to the measurement state.

Key functions are defined as follows:

KEY	1st Function	/2nd Function
◀	Back to main menu/	Move left
▶	Enter sub menu	/ Move right
▲	Move up	/ Add 1
▼	Move down	/ Minus 1
START	Enter	

Table 3-5 Key Functions

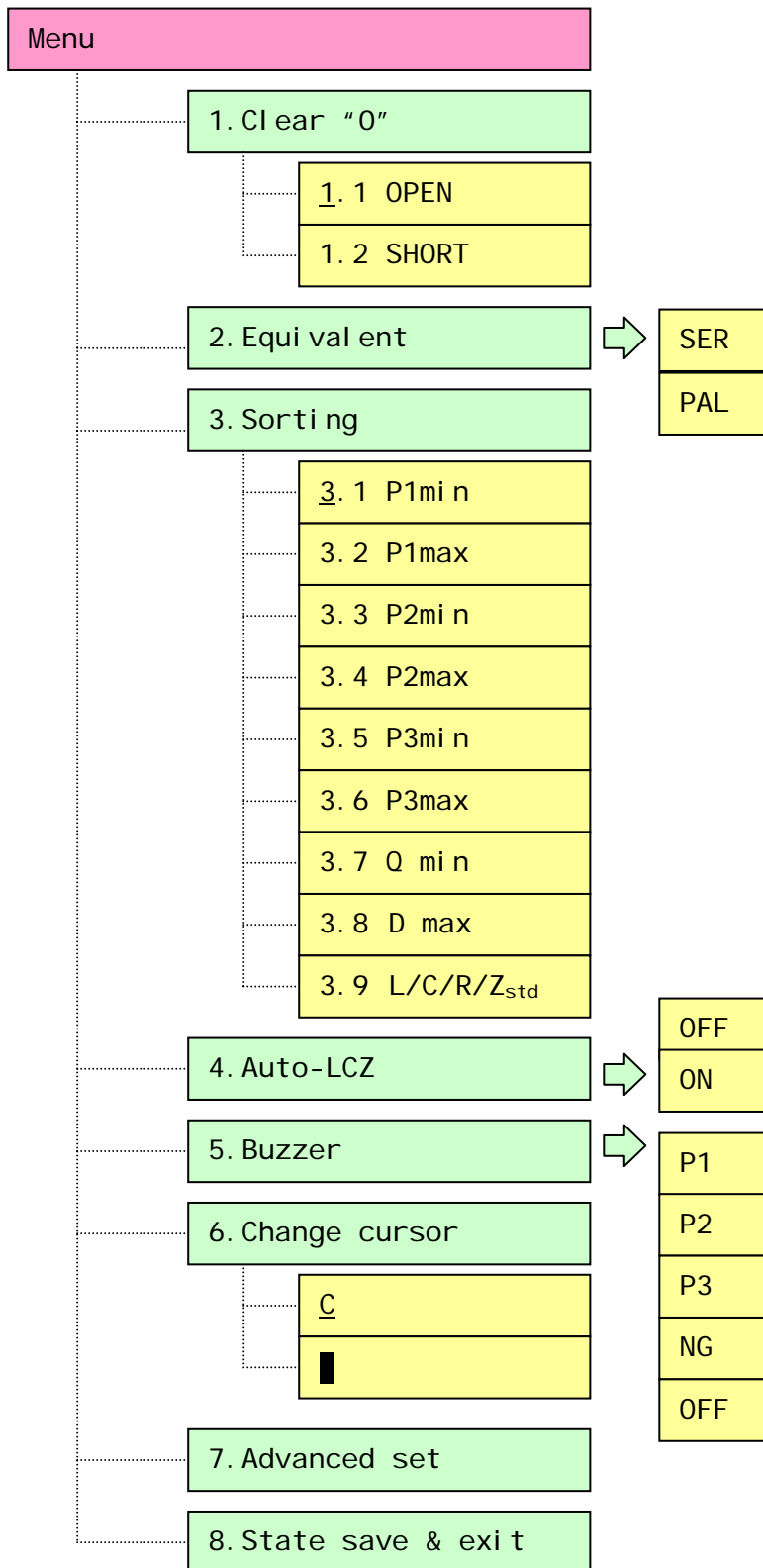



Figure 3-4 OSD Menu Tree

1. Clear "0"

- a) Press  button to enter clear "0" function.
- b) TH2820 can select OPEN or SHORT automatically:
When terminals are opened, cursor flashes under 1.1 OPEN;
When terminals are shorted, cursor flashes under 1.2 SHORT;
- c) When a component is connected to the terminals, the following information is displayed as shown in figure 3-5:

**Open or short
Connector!**

Figure 3-5 Open or short

Remove the component and select the open correction; Or insert the shorting plate and select the short correction.

- d) Press  key to start zero correction.
- e) The following information is displayed during zero correction:

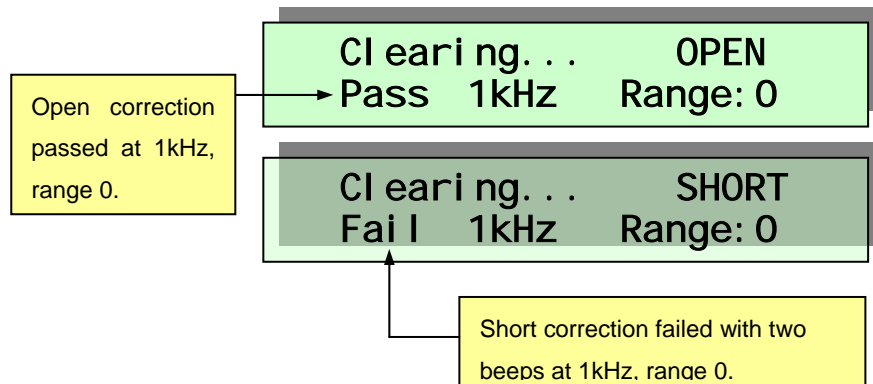



Figure 3-6 Zero correction in process

Notes:

1. *The correction function must be used in order to measure the device under test accurately. OPEN correction capability cancels errors due to the stray admittance (G , B) in parallel with the device under test. SHORT correction capability corrects for the residual impedance (R , X) in serial with the device under test. Perform correction again when measurement conditions are changed such as test fixture or environment temperature.*
2. *OPEN and SHORT correction should be performed at the same time.*
3. *The SHORT correction may be failed, if the measurement contacts are not shorted reliably. Make sure the test terminals are shorted, and then perform SHORT correction again.*
4. *Sweep correction — All ranges at each frequency are corrected. The correction data is stored in non-volatile memory. So you don't have to perform correction again, if only frequency is changed.*

2. Equivalent

a) Press  button to enter equivalent option;

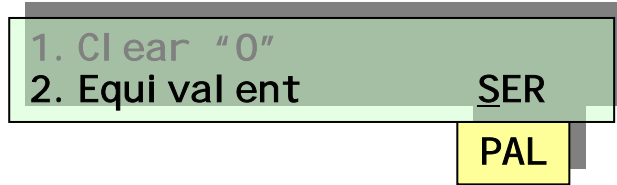



Figure 3-7 Equivalent Circuits

b) Use  and  buttons to select SER or PAL;

c) Press  or  to return.

Notes:

1. The actual capacitor, resistor and inductor are not the ideal capacitor, resistor and inductor. Normally, a component has the characteristics of the resistor and the reactor at the same time. The actual component is composed of an ideal resistor and reactor (ideal inductor or capacitor) in series or parallel equivalent circuits.
2. The values in the two different equivalent circuits can be converted to each other using the following formulas in Figure3-6. The values are different due to the quality factor Q (or the dissipation factor D).

Circuit Mode	Dissipation Factor	Conversion	
C		$D = \frac{1}{2\pi f C_p R_p} = \frac{1}{Q}$	$C_s = (1 + D^2) C_p$ $R_s = R_p D^2 / (1 + D^2)$
		$D = 2\pi f R_s C_s = \frac{1}{Q}$	$C_p = 1 / (1 + D^2) C_s$ $R_p = R_s (1 + D^2) / D^2$
L		$D = \frac{2\pi f L_p}{R_p} = \frac{1}{Q}$	$L_s = 1 / (1 + D^2) L_p$ $R_s = R_p D^2 / (1 + D^2)$
		$D = \frac{R_s}{2\pi f L_s} = \frac{1}{Q}$	$L_p = (1 + D^2) L_s$ $R_p = R_s (1 + D^2) / D^2$

Figure 3-6 Conversions between Series and Parallel Circuits

L: Inductor *C: Capacitor* *f: Frequency*
R: Resistor *D: Dissipation factor* *Q: Quality factor*
Suffix s: Series *Suffix p: Parallel*

3. From the above table, we can see that the parameters have relations with D^2 or Q^2 , and the value of D^2 will directly affect the values of the parameters. Take the following capacitor as an example:

Example: The capacitance in series model is $C_s = 0.1\mu\text{F}$, calculate the capacitance in parallel model for (a) $D1 = 0.0100$, (b) $D2 = 0.1000$ and (c) $D3 = 1.0000$.

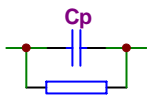
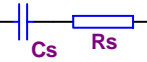
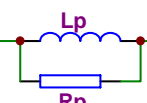
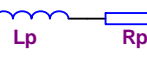
Solution: According to the formulas in table 3-6, the capacitances in parallel model are:

$$C_{p1} = 0.09999\mu\text{F}$$

$$C_{p2} = 0.09901\mu\text{F}$$

$$C_{p3} = 0.05\mu\text{F}.$$

You can find that, when $D < 0.01$, the difference between C_s and C_p is very small, but while $D > 0.01$, the difference will be very obvious. For example, when $D = 0.1$, the difference between C_s and C_p in percentage is approx 1%, while $D = 1$, the difference in percentage will be about 50%.

4. The following description gives some practical guidelines for selecting the capacitance measurement circuit mode.
- a) We can select the circuit mode according to the variation of D at two different frequencies. If the dissipation factor of a capacitor increases with the increase of the test frequency, series circuit mode should be selected. If the dissipation factor decreases with the increase of the test frequency, parallel circuit should be used. For inductor, the situation is just in the opposite side. In fact, D is impossible in direct ratio with the test frequency. From Figure 3-8, we can find that R_p and R_s exist at the same time. If R_s is more significant than R_p , series mode is selected; If R_p is more significant than R_s , parallel mode is more suitable.

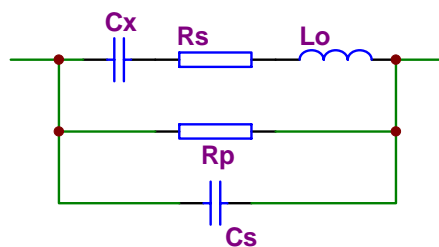

Figure3-8 Equivalent circuit of an actual capacitor

Where,

C_x : ideal capacitor

R_x : resistance of the leads

L_o : inductance of the leads

R_p : insulation resistance across the capacitor

C_o : stray capacitor across the capacitor.

For a given frequency F , C_s and C_p can be calculated.

b) Select the equivalent circuit according to the actual application in circuits. If a capacitor is used as a coupling capacitor, series circuit mode is the best choice; if a capacitor is used in a LC oscillator, then parallel circuit mode is more suitable.







c) When there is no proper information available, please make decision according to following rules:

For low impedance component (such as large capacitor or small inductor), the series equivalent circuit mode should be used.

For high impedance component (such as small capacitor or large inductor), the parallel equivalent circuit mode is the appropriate choice.

In general, when $|Z| < 10\Omega$, series equivalent measurement circuit should be used; When $|Z| > 10k\Omega$, parallel equivalent measurement circuit should be used; When $10\Omega < |Z| < 10k\Omega$, please choose proper equivalent measurement circuit according to the actual situation.

3. Sorting

- Press  button to enter sorting function son menu.
- Use  button to select a digit to be changed. Press  or  keys to change the digit value or sign (+/-).
- Press   button to select digit position or return, value is saved automatically when return.
- Press  key, you can directly return from value setup state or enter the unit setup state (When you setup nominal value) .

Notes:

- L, C, R and Z have the same sorting bin limits, but each nominal should be set respectively.
- The nominal value is determined by what kind of parameters is currently measured and displayed. Nominal Cstd is for C-D, Lstd for L-Q, Rstd for R-Q, and Zstd for Z-Q/Z-D.
- Sorting function is enabled under any display mode (Dir, Δ or $\Delta\%$) .
- In order to sort correctly, make sure that high limit must be greater than low limit for a pair of bin limits.

Flow Chart of Sorting

- Flow Chart of Sorting:

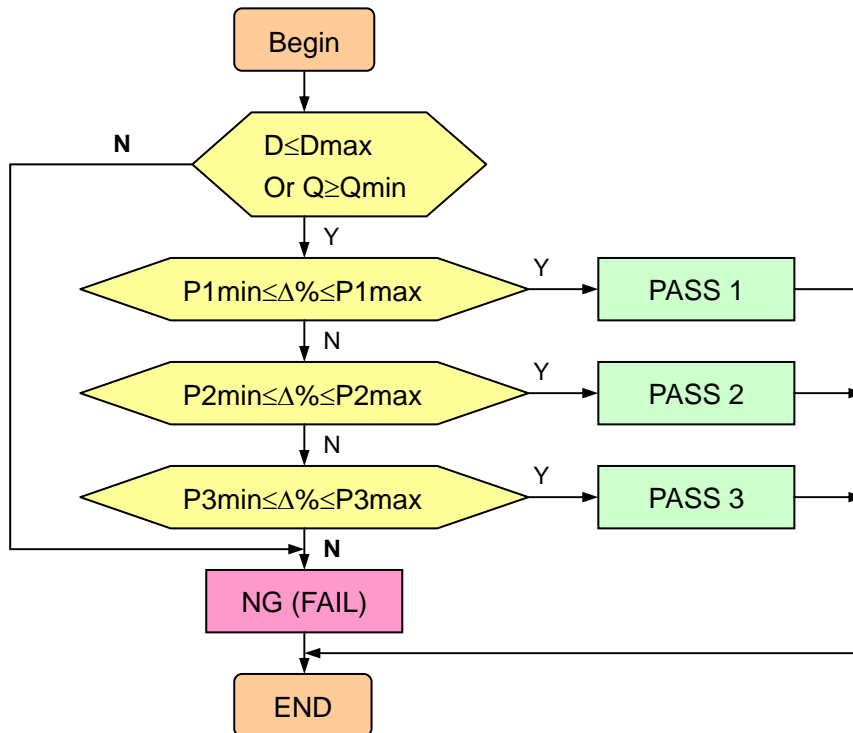



Figure3-9 Flow chart of sorting

4.LCZ auto

- a) Press  button to enter Auto-LCZ option:

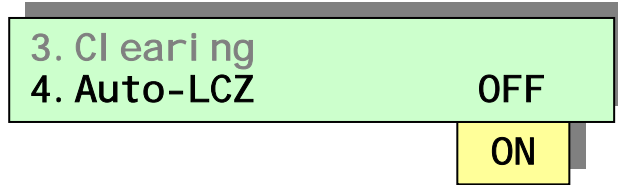







Figure3-10 Auto-LCZ option

- b) Press   buttons to select ON/OFF.
 c) Press  or  to return

Notes:

1. When $|Z| > 25M\Omega$, Z/Q is selected automatically.
2. When $|Z| < 80m\Omega$, Z/Q is selected.
3. When $80m\Omega < |Z| < 25M\Omega$:
 If $Q < 0.125$, Z/Q is selected;
 If $Q \geq 0.125$, L/Q is selected;
 If $Q \leq -0.125$, C/D is selected.

5.Buzzer

- a) Press  button to set buzzer state:

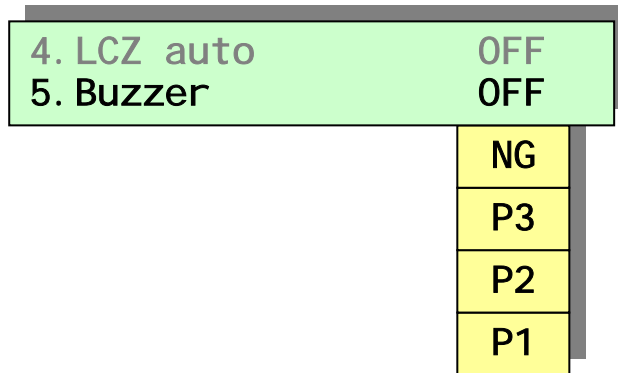







Figure 3-11 Set buzzer state

- b) Press   keys to select P1, P2, P3, NG and OFF states.
 c) Press  or  key to return, selected state is saved automatically.

6. Change cursor

- a) Press  key to set cursor shape:

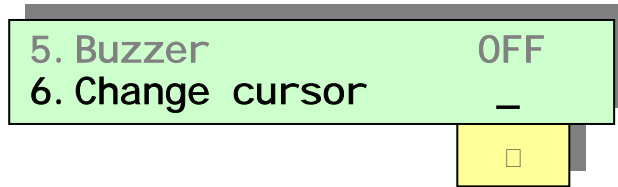





Figure3-12 Set cursor shape

- b) Press  or  keys to select _ or ■ .
 c) Press  or  key to return.

7. Advanced set

This function needs password. For instrument calibration only.



8. State save & exit

1. The following states are stored in non-volatile memory as the initial states when TH2820 is turned on next time:

- ① Measurement parameter;
- ② Measurement frequency;
- ③ Display mode;
- ④ Equivalent circuit model;
- ⑤ Auto-LCZ state;
- ⑥ Position of cursor.

2. Instrument returns to measuring state after saving the states

 Note :

Th2820 will exit the setup menu by pressing  or  key, but the changed states can not be saved.

Chapter 4 Maintenance and Measurement Basic

1 Input Protection

Internal circuit protection is designed to protect the instrument from damage by a charged capacitor,

When a charged capacitor is connected to the UNKNOWN terminals. The maximum capacitance is:

$$C_{MAX} = \frac{2.5}{U^2}$$

Where, U is the capacitor voltage (V), C_{MAX} is the maximum capacitance in Farads under the capacitor voltage U.

Typical values of U and C_{MAX} are shown in Table 4-1:

U	C_{MAX}
1000V	$\leq 2\mu\text{F}$
400V	$16\mu\text{F}$
125V	$160\mu\text{F}$
40V	$1600\mu\text{F}$
12.5V	$\leq 16000\mu\text{F}$

Table 4-1 Typical values of U and C_{MAX}

2 Measurement Contacts

TH2820's test terminals consists of four coaxial cables, the outer shield conductor of each cable is connected with Ground. Sometimes we also call it five test terminals. Five terminals are described as follows:

- HD : High current drive
- LD : Low current drive
- HS : High potential sample
- LS : Low potential sample
- ⊥ : Grounded shield

The ground shields are used reduce influence of stray capacitance and electromagnetic

disturbance. HD, HS and LD, LS should be connected at the lead of the component under test in order to reduce the influence of cable resistance and contact resistance especially in D measurement. When measuring low impedance, the drive terminals and sense terminals should be connected to leads of component separately so as to avoid the influence of lead resistance.

 Note:

In other words, HD, HS and LD, LS cannot be connected before connecting to the component otherwise measurement error will be caused. Refer to Figure 4-1.

If contact resistance and leads resistance R_{lead} are far less than the impedance tested (for example $R_{lead} < Z_x/1000$, and the accuracy required is 0.1%), then HD, HS and LD, LS can be connected together before connecting to the component under test (two-terminal measurement).

Test cable or fixture should meet the following requirements:

1. To minimize stray capacitance of the test leads, especially when component of high impedance is measured. (Such as small capacitor). How to eliminate the stray capacitance, please refer to the next paragraph.
2. To minimize contact resistance between contacting terminals and the device under test. Make sure that four-terminal measurement circuit configuration is constructed.
3. OPEN and SHORT correction can be performed. Zero correction is a very effective way to reduce the influence of stray impedance.

3 Stray Capacitance

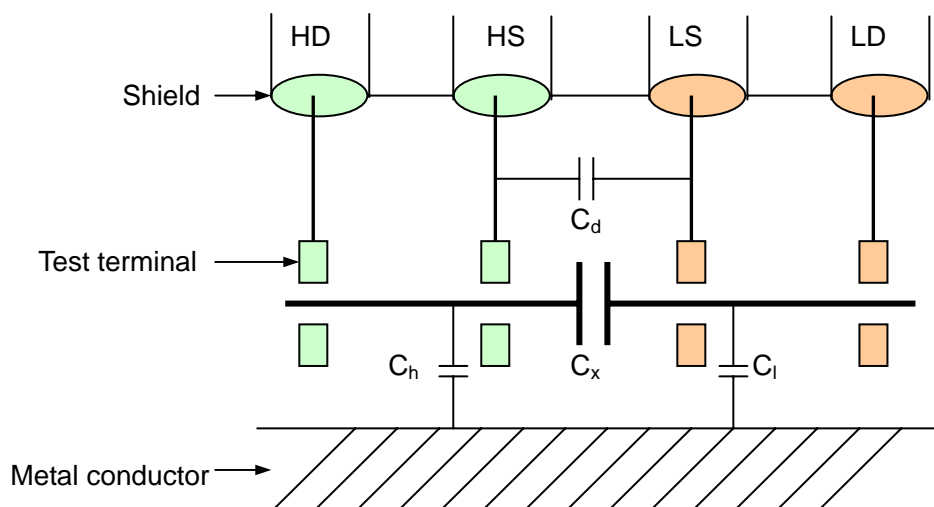

Figure 4-1 Capacitance to Ground

When component of high impedance (for example small capacitor) is measured, the influence of stray capacitance cannot be ignored. As shown in Figure 4-1, C_d is in parallel with C_x . When there is conductor board under the tested component, capacitance C_h is connected in series with C_i , then C_h and C_i are connected to with C_x in parallel. C_d , C_h and C_i will cause errors to measurement values. To place a grounded conductor between the high terminal and the lower terminal can reduce capacitor C_d . In addition, if the conductor board is grounded, C_h and C_i will be eliminated.

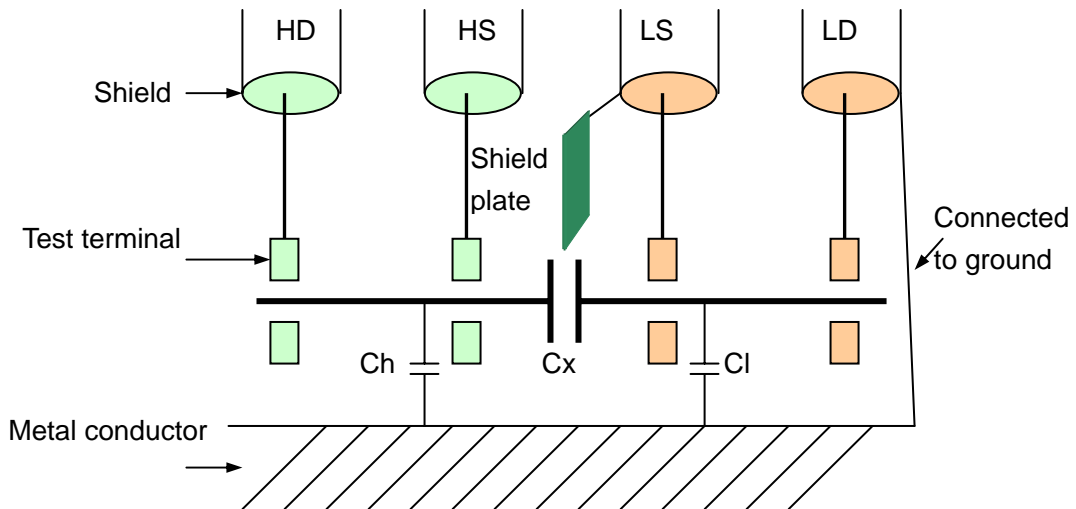

Figure 4-2 Reducing Capacitance to Ground

When low impedance component (for example small inductor or large capacitor) is measured, a larger current will flow through the test wires HD and LD. Electromagnetic coupling between the test wires will become the main source of error. Normally, the contact resistance will affect resistance part of the component while the electromagnetic coupling will affect reactance part of the component under test. The best way to eliminate the electromagnetic coupling is to adopt the four-terminal pair connection. But this instrument adopts the four-terminal connection instead of the four-terminal pair connection. A double-twisted test cable is also helpful to eliminate electromagnetic coupling, because the currents flow through HD and LD have the same magnitude but opposite directions, the magnetic fields induced by HD and LD cancel each other so no external magnetic fields are generated around the cable. There are two methods to make a double-twisted cable. The first method is that HD is twisted with LD and HS is twisted with LS. The other method is to twist the four wires directly. The first method is recommended.

Chapter 5 Contents and Warranty

1 Contents

After unpacking the shipping container, please do following checking:

- (1) Any signs of damage or scratching on the outlook of the products
- (2) Table of contents:

DESCRIPTION	QTY.	REMARK
TH2820 LCR Meter	1	
Power cable	1	
TH26004 test cable	1	
Fuse	2	1A
Calibration report	1	
QA Certificate	1	
Warranty Certificate	1	
User's Manual	1	

If any damages or incompleteness of contents are found when receiving the product, please immediately contact our company or our dealer from whom you purchased the product.

2 Warranty

Warranty Period : This product is warranted against defects in material and workmanship for a period of two years from the date of shipment.

Warranty certificate should be presented for warranty service or repair. Our Company provides lifetime service for our products.

The foregoing warranty shall not apply to defects resulting from improper or inadequate maintenance by Buyer, Buyer-supplied software or interfacing, unauthorized modification or misuse, operation outside of the environmental specifications for the product, or improper site preparation or maintenance. In this case, buyer shall pay charges for shipping and repair.